



# WORKBOOK

Release 01.17



## pendant lamp

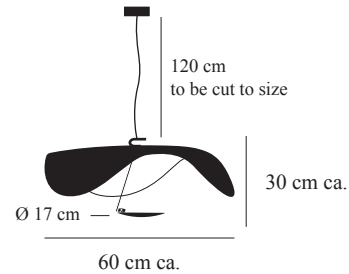

<b>Lederam Manta S1</b>	<i>110V or 240V</i>	source	type	watt	lumen	K	CRI	energy class	base	driver/transformer	dimming
LS1502 / shade white/white / gold rod / white disc	€ 635,00	mains voltage LED	LED module	1x17W	1590	2700 warm	80	A+	BC white Ø 9x3,5 cm	-	YES*
LS1802 / shade white/white / satin rod / white disc	€ 635,00	mains voltage LED	LED module	1x17W	1590	2700 warm	80	A+	BC white Ø 9x3,5 cm	-	YES*
LS11002 / shade white/white / white rod / white disc	€ 635,00	mains voltage LED	LED module	1x17W	1590	2700 warm	80	A+	BC white Ø 9x3,5 cm	-	YES*
LS1602 / shade white/gold / satin rod / white disc	€ 735,00	mains voltage LED	LED module	1x17W	1590	2700 warm	80	A+	BC white Ø 9x3,5 cm	-	YES*
LS1302 / shade black/gold / black rod / gold disc	€ 735,00	mains voltage LED	LED module	1x17W	1590	2700 warm	80	A+	BC black Ø 9x3,5 cm	-	YES*
LS1402 / shade black/copper / black rod / copper disc	€ 735,00	mains voltage LED	LED module	1x17W	1590	2700 warm	80	A+	BC black Ø 9x3,5 cm	-	YES*

## wall/ceiling lamp

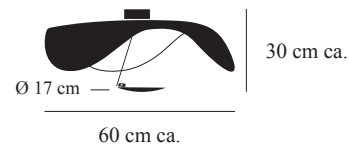

<b>Lederam Manta CWS1</b>	<i>110V or 240V</i>	source	type	watt	lumen	K	CRI	energy class	base	driver/transformer	dimming
LCWS1502 / shade white/white / gold rod / white disc	€ 575,00	mains voltage LED	LED module	1x17W	1590	2700 warm	80	A+	BC white Ø 9x3,5 cm	-	YES*
LCWS1802 / shade white/white / satin rod / white disc	€ 575,00	mains voltage LED	LED module	1x17W	1590	2700 warm	80	A+	BC white Ø 9x3,5 cm	-	YES*
LCWS11002 / shade white/white / white rod / white disc	€ 575,00	mains voltage LED	LED module	1x17W	1590	2700 warm	80	A+	BC white Ø 9x3,5 cm	-	YES*
LCWS1602 / shade white/gold / satin rod / white disc	€ 675,00	mains voltage LED	LED module	1x17W	1590	2700 warm	80	A+	BC white Ø 9x3,5 cm	-	YES*
LCWS1302 / shade black/gold / black rod / gold disc	€ 675,00	mains voltage LED	LED module	1x17W	1590	2700 warm	80	A+	BC black Ø 9x3,5 cm	-	YES*
LCWS1402 / shade black/copper / black rod / copper disc	€ 675,00	mains voltage LED	LED module	1x17W	1590	2700 warm	80	A+	BC black Ø 9x3,5 cm	-	YES*

## ceiling lamp

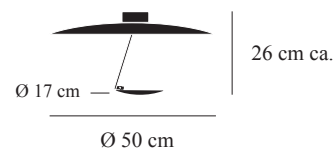

<b>Lederam C150</b>	<i>110V or 240V</i>	source	type	watt	lumen	K	CRI	energy class	base	driver/transformer	dimming
LC150502 / shade white/white / gold rod / white disc	€ 360,00	mains voltage LED	LED module	1x17W	1590	2700 warm	80	A+	BC white Ø 9x3,5 cm	-	YES*
LC150802 / shade white/white / satin rod / white disc	€ 360,00	mains voltage LED	LED module	1x17W	1590	2700 warm	80	A+	BC white Ø 9x3,5 cm	-	YES*
LC1501002 / shade white/white / white rod / white disc	€ 360,00	mains voltage LED	LED module	1x17W	1590	2700 warm	80	A+	BC white Ø 9x3,5 cm	-	YES*
LC150602 / shade white/gold / satin rod / white disc	€ 420,00	mains voltage LED	LED module	1x17W	1590	2700 warm	80	A+	BC white Ø 9x3,5 cm	-	YES*
LC150302 / shade black/gold / black rod / gold disc	€ 420,00	mains voltage LED	LED module	1x17W	1590	2700 warm	80	A+	BC black Ø 9x3,5 cm	-	YES*
LC150402 / shade black/copper / black rod / copper disc	€ 420,00	mains voltage LED	LED module	1x17W	1590	2700 warm	80	A+	BC black Ø 9x3,5 cm	-	YES*

C.P.

## ceiling lamp

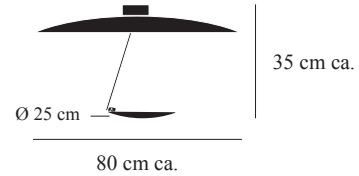

<b>Lederam C180</b>	<i>110V or 240V</i>	source	type	watt	lumen	K	CRI	energy class	base	driver/transformer	dimming
LC180502 / shade white/white / gold rod / white disc	€ 590,00	mains voltage LED	LED module	1x30W	2550	2700 warm	80	A+	BC white Ø 9x3,5 cm	-	YES*
LC180802 / shade white/white / satin rod / white disc	€ 590,00	mains voltage LED	LED module	1x30W	2550	2700 warm	80	A+	BC white Ø 9x3,5 cm	-	YES*
LC1801002 / shade white/white / white rod / white disc	€ 590,00	mains voltage LED	LED module	1x30W	2550	2700 warm	80	A+	BC white Ø 9x3,5 cm	-	YES*
LC180602 / shade white/gold / satin rod / white disc	€ 710,00	mains voltage LED	LED module	1x30W	2550	2700 warm	80	A+	BC white Ø 9x3,5 cm	-	YES*
LC180302 / shade black/gold / black rod / gold disc	€ 710,00	mains voltage LED	LED module	1x30W	2550	2700 warm	80	A+	BC black Ø 9x3,5 cm	-	YES*
LC180402 / shade black/copper / black rod / copper disc	€ 710,00	mains voltage LED	LED module	1x30W	2550	2700 warm	80	A+	BC black Ø 9x3,5 cm	-	YES*

## wall lamp

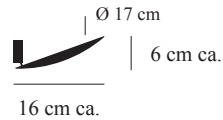

<b>Lederam WF Ø 17 cm</b>	<i>110V or 240V</i>	source	type	watt	lumen	K	CRI	energy class	base	driver/transformer	dimming
LWF17602 / white	€ 175,00	mains voltage LED	LED module	1x17W	1590	2700 warm	80	A+	white Ø 5,5x1,5 cm	-	YES*
LWF17102 / black	€ 175,00	mains voltage LED	LED module	1x17W	1590	2700 warm	80	A+	black Ø 5,5x1,5 cm	-	YES*
LWF17302 / gold	€ 215,00	mains voltage LED	LED module	1x17W	1590	2700 warm	80	A+	white Ø 5,5x1,5 cm	-	YES*
LWF17402 / copper	€ 215,00	mains voltage LED	LED module	1x17W	1590	2700 warm	80	A+	white Ø 5,5x1,5 cm	-	YES*
LWF171102 / bronze	€ 245,00	mains voltage LED	LED module	1x17W	1590	2700 warm	80	A+	black Ø 5,5x1,5 cm	-	YES*

## wall lamp

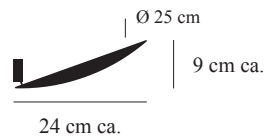

<b>Lederam WF Ø 25 cm</b>	<i>110V or 240V</i>	source	type	watt	lumen	K	CRI	energy class	base	driver/transformer	dimming
LWF25602 / white	€ 230,00	mains voltage LED	LED module	1x28W	2550	2700 warm	80	A+	white Ø 5,5x1,5 cm	-	YES*
LWF25102 / black	€ 230,00	mains voltage LED	LED module	1x28W	2550	2700 warm	80	A+	black Ø 5,5x1,5 cm	-	YES*
LWF25302 / gold	€ 280,00	mains voltage LED	LED module	1x28W	2550	2700 warm	80	A+	white Ø 5,5x1,5 cm	-	YES*
LWF25402 / copper	€ 280,00	mains voltage LED	LED module	1x28W	2550	2700 warm	80	A+	white Ø 5,5x1,5 cm	-	YES*
LWF251102 / bronze	€ 320,00	mains voltage LED	LED module	1x28W	2550	2700 warm	80	A+	black Ø 5,5x1,5 cm	-	YES*

wall recessed lamp

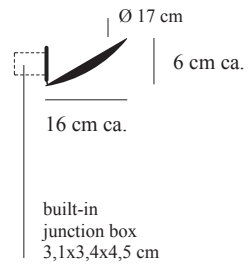

	<b>Lederam WFI</b> Ø 17 cm	<i>110V or 240V</i>	source	type	watt	lumen	K	CRI	energy class	base	driver/transformer	dimming
LWFI17602 / white	€ 150,00		mains voltage LED	LED module	1x17W	1590	2700 warm	80	A+	white Ø 7,4x0,5 cm	-	YES*
LWFI17102 / black	€ 150,00		mains voltage LED	LED module	1x17W	1590	2700 warm	80	A+	black Ø 7,4x0,5 cm	-	YES*
LWFI17302 / gold	€ 190,00		mains voltage LED	LED module	1x17W	1590	2700 warm	80	A+	white Ø 7,4x0,5 cm	-	YES*
LWFI17402 / copper	€ 190,00		mains voltage LED	LED module	1x17W	1590	2700 warm	80	A+	white Ø 7,4x0,5 cm	-	YES*
LWFI171102 / bronze	€ 220,00		mains voltage LED	LED module	1x17W	1590	2700 warm	80	A+	black Ø 7,4x0,5 cm	-	YES*

C.P.

wall recessed lamp

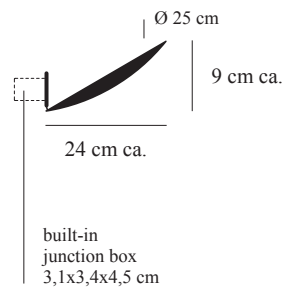

	<b>Lederam WFI</b> Ø 25 cm	<i>110V or 240V</i>	source	type	watt	lumen	K	CRI	energy class	base	driver/transformer	dimming
LWFI25602 / white	€ 205,00		mains voltage LED	LED module	1x28W	2550	2700 warm	80	A+	white Ø 7,4x0,5 cm	-	YES*
LWFI25102 / black	€ 205,00		mains voltage LED	LED module	1x28W	2550	2700 warm	80	A+	black Ø 7,4x0,5 cm	-	YES*
LWFI25302 / gold	€ 255,00		mains voltage LED	LED module	1x28W	2550	2700 warm	80	A+	white Ø 7,4x0,5 cm	-	YES*
LWFI25402 / copper	€ 255,00		mains voltage LED	LED module	1x28W	2550	2700 warm	80	A+	white Ø 7,4x0,5 cm	-	YES*
LWFI251102 / bronze	€ 295,00		mains voltage LED	LED module	1x28W	2550	2700 warm	80	A+	black Ø 7,4x0,5 cm	-	YES*

C.P.

wall lamp

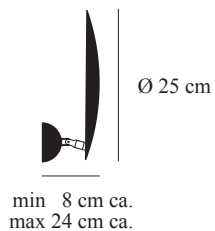

	<b>Lederam W1</b> Ø 25 cm	<i>110V or 240V</i>	source	type	watt	lumen	K	CRI	energy class	base	driver/transformer	dimming
LW125602 / white	€ 270,00		mains voltage LED	LED module	1x17W	1590	2700 warm	80	A+	BE white Ø 6,5x3 cm	-	YES*
LW125102 / black	€ 270,00		mains voltage LED	LED module	1x17W	1590	2700 warm	80	A+	BE black Ø 6,5x3 cm	-	YES*
LW125302 / gold	€ 320,00		mains voltage LED	LED module	1x17W	1590	2700 warm	80	A+	BE black Ø 6,5x3 cm	-	YES*
LW125402 / copper	€ 320,00		mains voltage LED	LED module	1x17W	1590	2700 warm	80	A+	BE black Ø 6,5x3 cm	-	YES*

**LEDERAM: COLOUR COMBINATIONS AND DETAILS**

Lederam S1, CWS1	code	shade		rod	disc	base
		external	internal			
	3	black	gold	black	gold	black
	4	black	copper	black	copper	black
	5	white	white	gold	white	white
	6	white	gold	satin	white	white
	8	white	white	satin	white	white
	10	white	white	white	white	white

Lederam C150, C180	code	shade		rod	disc	base
		external	internal			
	3	black	gold	black	gold	black
	4	black	copper	black	copper	black
	5	white	white	gold	white	white
	6	white	gold	satin	white	white
	8	white	white	satin	white	white
	10	white	white	white	white	white

Lederam WF, WFI	code	disc		base
		external	internal	
	1	black	black	black
	3	gold	white	white
	4	copper	white	white
	6	white	white	white
	11	bronze	black	black

Lederam W1	code	disc		joint	base
		external	internal		
	1	black	black	nickel	black
	3	gold	black	nickel	black
	4	copper	black	nickel	black
	6	white	white	nickel	white

pendant lamp

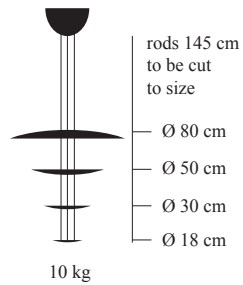
**Macchina della Luce mod. A LED**

220-240V

		source	type	watt	lumen	K	CRI	energy class	base	driver/transformer	dimming
MALD / gold	€ 1.885,00	low voltage 24V DC LED board	LED board	7x6W	4410	2600- 2800*	80	A	BB nickel Ø 21x10,5 cm	24V DC	Triac
MALDAG / silver	€ 1.885,00	low voltage 24V DC LED board	LED board	7x6W	4410	2600- 2800*	80	A	BB nickel Ø 21x10,5 cm	24V DC	Triac
MALDR / copper	€ 1.885,00	low voltage 24V DC LED board	LED board	7x6W	4410	2600- 2800*	80	A	BB nickel Ø 21x10,5 cm	24V DC	Triac

rods 300 cm available on request

available on request 1...10V or DALI dimmable version

pendant lamp

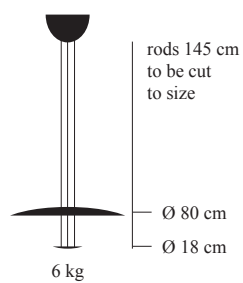
**Macchina della Luce mod. B LED**

220-240V

		source	type	watt	lumen	K	CRI	energy class	base	driver/transformer	dimming
MBLD / gold	€ 1.145,00	low voltage 24V DC LED board	LED board	2x6W	1260	2600- 2800*	80	A	BB nickel Ø 21x10,5 cm	24V DC	Triac
MBLDAG / silver	€ 1.145,00	low voltage 24V DC LED board	LED board	2x6W	1260	2600- 2800*	80	A	BB nickel Ø 21x10,5 cm	24V DC	Triac
MBLDR / copper	€ 1.145,00	low voltage 24V DC LED board	LED board	2x6W	1260	2600- 2800*	80	A	BB nickel Ø 21x10,5 cm	24V DC	Triac

rods 300 cm available on request

available on request 1...10V or DALI dimmable version

pendant lamp

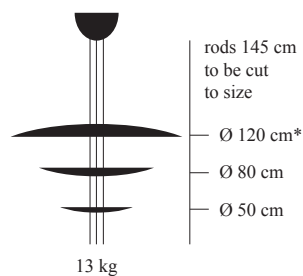
**Macchina della Luce mod. C LED**

220-240V

		source	type	watt	lumen	K	CRI	energy class	base	driver/transformer	dimming
MCLD / gold	€ 2.610,00	low voltage 24V DC LED board	LED board	7x6W	4410	2600- 2800*	80	A	BB nickel Ø 21x10,5 cm	24V DC	Triac
MCLDAG / silver	€ 2.610,00	low voltage 24V DC LED board	LED board	7x6W	4410	2600- 2800*	80	A	BB nickel Ø 21x10,5 cm	24V DC	Triac
MCLDR / copper	€ 2.610,00	low voltage 24V DC LED board	LED board	7x6W	4410	2600- 2800*	80	A	BB nickel Ø 21x10,5 cm	24V DC	Triac

rods 300 cm available on request

\* with flying leaf

available on request 1...10V or DALI dimmable version

pendant lamp

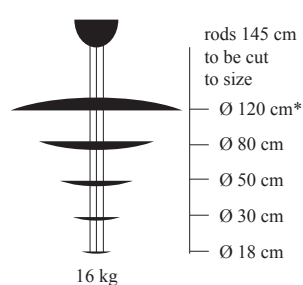
**Macchina della Luce mod. D LED**

220-240V

		source	type	watt	lumen	K	CRI	energy class	base	driver/transformer	dimming
MDLD / gold	€ 3.040,00	low voltage 24V DC LED board	LED board	10x6W	6300	2600- 2800*	80	A	BB nickel Ø 21x10,5 cm	24V DC	Triac
MDLDAG / silver	€ 3.040,00	low voltage 24V DC LED board	LED board	10x6W	6300	2600- 2800*	80	A	BB nickel Ø 21x10,5 cm	24V DC	Triac
MDLDR / copper	€ 3.040,00	low voltage 24V DC LED board	LED board	10x6W	6300	2600- 2800*	80	A	BB nickel Ø 21x10,5 cm	24V DC	Triac

rods 300 cm available on request

\* with flying leaf

available on request 1...10V or DALI dimmable version

pendant lamp

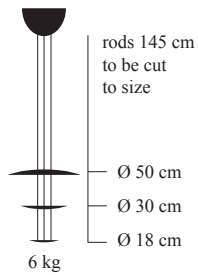
**Macchina della Luce mod. E LED**

220-240V

		source	type	watt	lumen	K	CRI	energy class	base	driver/transformer	dimming
MELD / gold	€ 1.115,00	low voltage 24V DC LED board	LED board	4x6W	2520	2600- 2800*	80	A	BB nickel Ø 21x10,5 cm	24V DC	Triac
MELDAG / silver	€ 1.115,00	low voltage 24V DC LED board	LED board	4x6W	2520	2600- 2800*	80	A	BB nickel Ø 21x10,5 cm	24V DC	Triac
MELDR / copper	€ 1.115,00	low voltage 24V DC LED board	LED board	4x6W	2520	2600- 2800*	80	A	BB nickel Ø 21x10,5 cm	24V DC	Triac

rods 300 cm available on request

available on request 1...10V or DALI dimmable version

pendant lamp

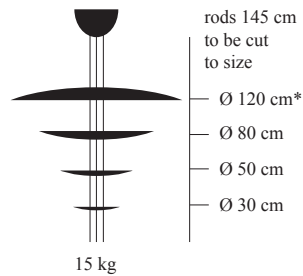
**Macchina della Luce mod. F LED**

220-240V

		source	type	watt	lumen	K	CRI	energy class	base	driver/transformer	dimming
MFLD / gold	€ 2.890,00	low voltage 24V DC LED board	LED board	9x6W	5670	2600- 2800*	80	A	BB nickel Ø 21x10,5 cm	24V DC	Triac
MFLDAG / silver	€ 2.890,00	low voltage 24V DC LED board	LED board	9x6W	5670	2600- 2800*	80	A	BB nickel Ø 21x10,5 cm	24V DC	Triac
MFLDR / copper	€ 2.890,00	low voltage 24V DC LED board	LED board	9x6W	5670	2600- 2800*	80	A	BB nickel Ø 21x10,5 cm	24V DC	Triac

rods 300 cm available on request

\* with flying leaf

available on request 1...10V or DALI dimmable version

pendant lamp

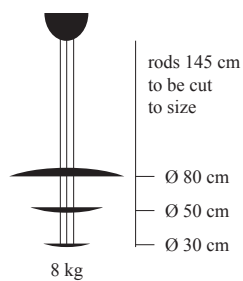
**Macchina della Luce mod. I LED**

220-240V

		source	type	watt	lumen	K	CRI	energy class	base	driver/transformer	dimming
MILD / gold	€ 1.570,00	low voltage 24V DC LED board	LED board	5x6W	3150	2600- 2800*	80	A	BB nickel Ø 21x10,5 cm	24V DC	Triac
MILDAG / silver	€ 1.570,00	low voltage 24V DC LED board	LED board	5x6W	3150	2600- 2800*	80	A	BB nickel Ø 21x10,5 cm	24V DC	Triac
MILDR / copper	€ 1.570,00	low voltage 24V DC LED board	LED board	5x6W	3150	2600- 2800*	80	A	BB nickel Ø 21x10,5 cm	24V DC	Triac

rods 300 cm available on request

available on request 1...10V or DALI dimmable version

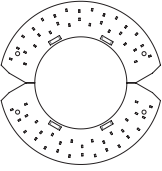
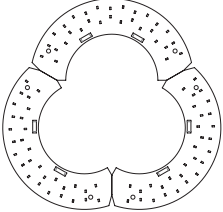
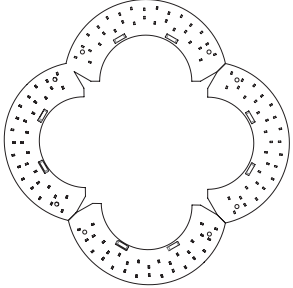

**MACCHINA DELLA LUCE: LED BOARDS**

<p><b>α</b></p>	<p>2 x LED board 6W 24V DC 12W</p>	
<p><b>β</b></p>	<p>3 x LED board 6W 24V DC 18W</p>	
<p><b>γ</b></p>	<p>4 x LED board 6W 24V DC 24W</p>	

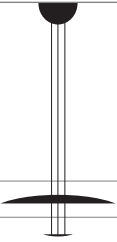
<p><b>Mod. A</b></p>	<p>42W / 4410 lumen</p>	 <table border="1" data-bbox="776 1204 1169 1340"> <tr> <td>Ø 80 cm</td> <td></td> <td></td> <td></td> </tr> <tr> <td>Ø 50 cm</td> <td><b>β</b></td> <td>18W</td> <td></td> </tr> <tr> <td>Ø 30 cm</td> <td><b>α</b></td> <td>12W</td> <td></td> </tr> <tr> <td>Ø 18 cm</td> <td><b>α</b></td> <td>12W</td> <td></td> </tr> </table>	Ø 80 cm				Ø 50 cm	<b>β</b>	18W		Ø 30 cm	<b>α</b>	12W		Ø 18 cm	<b>α</b>	12W	
Ø 80 cm																		
Ø 50 cm	<b>β</b>	18W																
Ø 30 cm	<b>α</b>	12W																
Ø 18 cm	<b>α</b>	12W																
<p><b>Mod. B</b></p>	<p>12W / 1260 lumen</p>	 <table border="1" data-bbox="776 1589 1169 1654"> <tr> <td>Ø 80 cm</td> <td></td> <td></td> <td></td> </tr> <tr> <td>Ø 18 cm</td> <td><b>α</b></td> <td>12W</td> <td></td> </tr> </table>	Ø 80 cm				Ø 18 cm	<b>α</b>	12W									
Ø 80 cm																		
Ø 18 cm	<b>α</b>	12W																

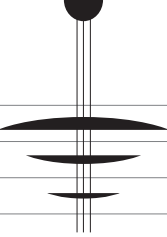
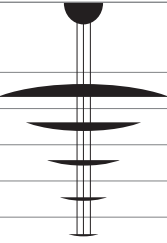
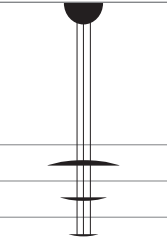
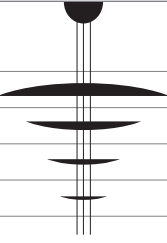
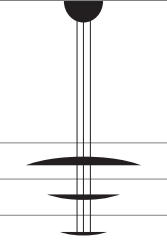
<p><b>Mod. C</b></p>	<p>42W / 4410 lumen</p>	 <table border="1" data-bbox="2036 263 2429 367"> <tr> <td>Ø 120 cm</td> <td></td> <td></td> <td></td> </tr> <tr> <td>Ø 80 cm</td> <td><b>γ</b></td> <td>24W</td> <td></td> </tr> <tr> <td>Ø 50 cm</td> <td><b>β</b></td> <td>18W</td> <td></td> </tr> </table>	Ø 120 cm				Ø 80 cm	<b>γ</b>	24W		Ø 50 cm	<b>β</b>	18W									
Ø 120 cm																						
Ø 80 cm	<b>γ</b>	24W																				
Ø 50 cm	<b>β</b>	18W																				
<p><b>Mod. D</b></p>	<p>60W / 6300 lumen</p>	 <table border="1" data-bbox="2036 542 2429 713"> <tr> <td>Ø 120 cm</td> <td></td> <td></td> <td></td> </tr> <tr> <td>Ø 80 cm</td> <td><b>β</b></td> <td>18W</td> <td></td> </tr> <tr> <td>Ø 50 cm</td> <td><b>β</b></td> <td>18W</td> <td></td> </tr> <tr> <td>Ø 30 cm</td> <td><b>α</b></td> <td>12W</td> <td></td> </tr> <tr> <td>Ø 18 cm</td> <td><b>α</b></td> <td>12W</td> <td></td> </tr> </table>	Ø 120 cm				Ø 80 cm	<b>β</b>	18W		Ø 50 cm	<b>β</b>	18W		Ø 30 cm	<b>α</b>	12W		Ø 18 cm	<b>α</b>	12W	
Ø 120 cm																						
Ø 80 cm	<b>β</b>	18W																				
Ø 50 cm	<b>β</b>	18W																				
Ø 30 cm	<b>α</b>	12W																				
Ø 18 cm	<b>α</b>	12W																				
<p><b>Mod. E</b></p>	<p>24W / 2520 lumen</p>	 <table border="1" data-bbox="2036 928 2429 1026"> <tr> <td>Ø 50 cm</td> <td></td> <td></td> <td></td> </tr> <tr> <td>Ø 30 cm</td> <td><b>α</b></td> <td>12W</td> <td></td> </tr> <tr> <td>Ø 18 cm</td> <td><b>α</b></td> <td>12W</td> <td></td> </tr> </table>	Ø 50 cm				Ø 30 cm	<b>α</b>	12W		Ø 18 cm	<b>α</b>	12W									
Ø 50 cm																						
Ø 30 cm	<b>α</b>	12W																				
Ø 18 cm	<b>α</b>	12W																				
<p><b>Mod. F</b></p>	<p>54W / 5670 lumen</p>	 <table border="1" data-bbox="2036 1170 2429 1304"> <tr> <td>Ø 120 cm</td> <td></td> <td></td> <td></td> </tr> <tr> <td>Ø 80 cm</td> <td><b>γ</b></td> <td>24W</td> <td></td> </tr> <tr> <td>Ø 50 cm</td> <td><b>β</b></td> <td>18W</td> <td></td> </tr> <tr> <td>Ø 30 cm</td> <td><b>α</b></td> <td>12W</td> <td></td> </tr> </table>	Ø 120 cm				Ø 80 cm	<b>γ</b>	24W		Ø 50 cm	<b>β</b>	18W		Ø 30 cm	<b>α</b>	12W					
Ø 120 cm																						
Ø 80 cm	<b>γ</b>	24W																				
Ø 50 cm	<b>β</b>	18W																				
Ø 30 cm	<b>α</b>	12W																				
<p><b>Mod. I</b></p>	<p>30W / 3150 lumen</p>	 <table border="1" data-bbox="2036 1555 2429 1654"> <tr> <td>Ø 80 cm</td> <td></td> <td></td> <td></td> </tr> <tr> <td>Ø 50 cm</td> <td><b>β</b></td> <td>18W</td> <td></td> </tr> <tr> <td>Ø 30 cm</td> <td><b>α</b></td> <td>12W</td> <td></td> </tr> </table>	Ø 80 cm				Ø 50 cm	<b>β</b>	18W		Ø 30 cm	<b>α</b>	12W									
Ø 80 cm																						
Ø 50 cm	<b>β</b>	18W																				
Ø 30 cm	<b>α</b>	12W																				

pendant lamp

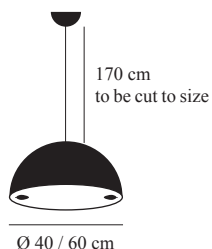

	<b>Stchu-Moon 02 LED</b>	220-240V	source	type	watt	lumen	K	CRI	energy class	base	driver/transformer	dimming
SM24L / Ø 40 cm / silver	€ 720,00		low voltage 24V DC LED board	LED board	2x5W	1000	2600- 2800*	80	A	BB black Ø 15x7,5 cm	24V DC	Triac
SM24LO / Ø 40 cm / gold	€ 720,00		low voltage 24V DC LED board	LED board	2x5W	1000	2600- 2800*	80	A	BB black Ø 15x7,5 cm	24V DC	Triac
SM24LR / Ø 40 cm / copper	€ 720,00		low voltage 24V DC LED board	LED board	2x5W	1000	2600- 2800*	80	A	BB black Ø 15x7,5 cm	24V DC	Triac
SM26L / Ø 60 cm / silver	€ 940,00		low voltage 24V DC LED board	LED board	2x5W	1000	2600- 2800*	80	A	BB black Ø 15x7,5 cm	24V DC	Triac
SM26LO / Ø 60 cm / gold	€ 940,00		low voltage 24V DC LED board	LED board	2x5W	1000	2600- 2800*	80	A	BB black Ø 15x7,5 cm	24V DC	Triac
SM26LR / Ø 60 cm / copper	€ 940,00		low voltage 24V DC LED board	LED board	2x5W	1000	2600- 2800*	80	A	BB black Ø 15x7,5 cm	24V DC	Triac

available on request 1...10V or DALI dimmable version

pendant lamp

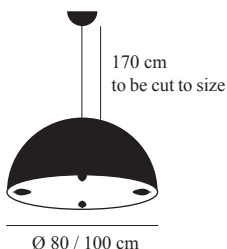

	<b>Stchu-Moon 02 LED</b>	220-240V	source	type	watt	lumen	K	CRI	energy class	base	driver/transformer	dimming
SM28L / Ø 80 cm / silver	€ 1.330,00		low voltage 24V DC LED board	LED board	4x5W	2000	2600- 2800*	80	A	BB black Ø 15x7,5 cm	24V DC	Triac
SM28LO / Ø 80 cm / gold	€ 1.330,00		low voltage 24V DC LED board	LED board	4x5W	2000	2600- 2800*	80	A	BB black Ø 15x7,5 cm	24V DC	Triac
SM28LR / Ø 80 cm / copper	€ 1.330,00		low voltage 24V DC LED board	LED board	4x5W	2000	2600- 2800*	80	A	BB black Ø 15x7,5 cm	24V DC	Triac
SM210L / Ø 100 cm / silver	€ 1.890,00		low voltage 24V DC LED board	LED board	4x5W	2000	2600- 2800*	80	A	BB black Ø 15x7,5 cm	24V DC	Triac
SM210LO / Ø 100 cm / gold	€ 1.890,00		low voltage 24V DC LED board	LED board	4x5W	2000	2600- 2800*	80	A	BB black Ø 15x7,5 cm	24V DC	Triac
SM210LR / Ø 100 cm / copper	€ 1.890,00		low voltage 24V DC LED board	LED board	4x5W	2000	2600- 2800*	80	A	BB black Ø 15x7,5 cm	24V DC	Triac

available on request 1...10V or DALI dimmable version

pendant lamp

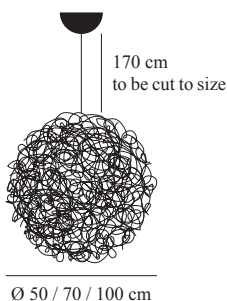

	<b>Fil de Fer LED TRIAC</b>	110V or 240V	source	type	watt	lumen	K	CRI	energy class	base	driver/transformer	dimming
F5SLD / Ø 50 cm / aluminium	€ 1.050,00		low voltage LED bulb	G4	12x1,8W	2400	2700- 2900**	> 80	A+	BB nickel Ø 21x10,5 cm	low voltage electronic 12V DC	Triac
F5SLDOR / Ø 50 cm / gold	€ 1.290,00		low voltage LED bulb	G4	12x1,8W	2400	2700- 2900**	> 80	A+	BB gold leaf Ø 21x10,5 cm	low voltage electronic 12V DC	Triac
F7SLD / Ø 70 cm / aluminium	€ 1.450,00		low voltage LED bulb	G4	18x1,8W	3600	2700- 2900**	> 80	A+	BB nickel Ø 21x10,5 cm	low voltage electronic 12V DC	Triac
F7SLDOR / Ø 70 cm / gold	€ 1.810,00		low voltage LED bulb	G4	18x1,8W	3600	2700- 2900**	> 80	A+	BB gold leaf Ø 21x10,5 cm	low voltage electronic 12V DC	Triac
F10SLD / Ø 100 cm / aluminium	€ 1.950,00		low voltage LED bulb	G4	24x1,8W	4800	2700- 2900**	> 80	A+	BB nickel Ø 21x10,5 cm	low voltage electronic 12V DC	Triac
F10SLDOR / Ø 100 cm / gold	€ 2.435,00		low voltage LED bulb	G4	24x1,8W	4800	2700- 2900**	> 80	A+	BB gold leaf Ø 21x10,5 cm	low voltage electronic 12V DC	Triac

available on request 1...10V or DALI dimmable version

**STCHU-MOON: LED BOARDS**

LED board 5W 24V DC

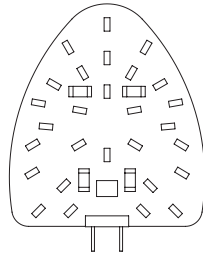

<p><b>Ø 40/60</b></p>	<p>10W / 1000 lumen</p>	
<p><b>Ø 80/100</b></p>	<p>20W / 2000 lumen</p>	

**FIL DE FER: LED BULB**

LED bulb 1,8W



<p><b>Ø 50</b></p>	<p>21,6W / 2400 lumen</p>	
<p><b>Ø 70</b></p>	<p>32,4W / 3600 lumen</p>	
<p><b>Ø 100</b></p>	<p>43,2W / 4800 lumen</p>	

Design:  
Enzo Catellani  
Guido Parenzan

Catellani & Smith

Offices

Via Antonio Locatelli, 47  
I-24020 Villa di Serio BG  
Tel. +39 035 656088  
Fax +39 035 655605  
info@catellanismith.com  
www.catellanismith.com

Show-room

Via Jacopo Palma il Vecchio, 3  
I-24122 Bergamo  
Tel.-Fax +39 035 210193  
show-room@catellanismith.com

Catellani & Smith reserves  
the right to make technical  
or aesthetical modifications  
without notice.



Catellani & Smith<sup>®</sup>