



Update
Pricelist
JULY 2020

INDEX



polyvarnished
brass



black



white



gunmetal



bronze



copper



chrome



oxide



quartz



gold



silver



aluminium



grey



ano

Floor/Table

p.4

Wall/Ceiling

p.8

Suspension

p.44

Recessed

p.83

Track

p.105

Outdoor

p.109

Floor/Table



2THIRTY FLOOR

2THIRTY FLOOR 1	5
2THIRTY FLOOR 2	5



AUSTERE FLOOR / TABLE

AUSTERE-Floor	6
AUSTERE-Table	6



BOULY TABLE

BOULY TABLE built-in	7
BOULY TABLE	7



SCAR-LED TABLE

SCAR-LED TABLE built-in	7
SCAR-LED TABLE	7

RING	DIM	BASE	ROD	FRAME	SWIVEL	RETAIL PRICE VAT. EXCL.
		●	●	●	●	

2Thirty Floor 1 + honeycomb



●	PU	THFDI 12223H	◆	680€
●	PU	THFDI 17223H	◆	680€
●	PU	THFDI 18223H	◆	680€

110V-230V - **PUSH-DIM on armature - EU-plug on cable**

1 x LED array 11.8W - 350mA - 1 x 1241lm - 2700K - CRI >97

◆ Choose beam: N=narrow 12° or M=medium 24°

Optional ring without honeycomb: see below

LED included - Floor -

OPTIONAL RING FOR 2THIRTY



●		TH 200R		23€
●		TH 700R		23€
●		TH 800R		23€

OPTIONAL BASE DISC FOR OPTIMAL STABILITY



●		THBA 0002		58€
---	--	-----------	--	-----

2Thirty Floor 2 + honeycomb

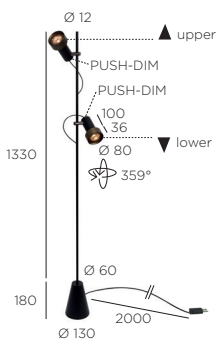

●	PU	THFDI 22223H	▲▼	1.015€
●	PU	THFDI 27223H	▲▼	1.015€
●	PU	THFDI 28223H	▲▼	1.015€

110V-230V - **PUSH-DIM on armature - EU-plug on cable**

2 x LED array 11.8W - 350mA - 2 x 1241lm - 2700K - CRI >97

▲ = Choose beam upper lightsource: N=narrow 12° or M=medium 24°

▼ = Choose beam lower lightsource: N=narrow 12° or M=medium 24°

Optional ring without honeycomb: see below

LED included - Floor -

OPTIONAL RING FOR 2THIRTY



●		TH 200R		23€
●		TH 700R		23€
●		TH 800R		23€

OPTIONAL BASE DISC FOR OPTIMAL STABILITY



●		THBA 0002		58€
---	--	-----------	--	-----

FRAME	FRAME	FRAME	FRAME	RETAIL PRICE VAT. EXCL.
				

AUSTERE-FLOOR

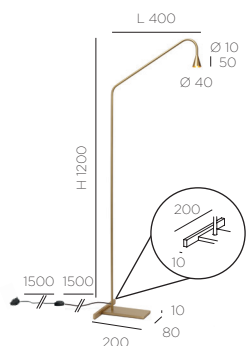



With EU plug	HVFL 1003	HVFL 1002	HVFL 1001		625€
With EU plug				HVFL 1004	730€
With UK plug*	HVFL 1003UK	HVFL 1002UK	HVFL 1001UK		625€
With UK plug*				HVFL 1004UK	730€
With US plug*	HVFL 1003US	HVFL 1002US	HVFL 1001US		625€
With US plug*				HVFL 1004US	730€
With AU plug*	HVFL 1003AU	HVFL 1002AU	HVFL 1001AU		625€
With AU plug*				HVFL 1004AU	730€

230V - **plugdriver with push button dimmer on cable**
 *110V-230V - **plugdriver with push button dimmer on cable**
 1 x LED array 6,2W - 350mA - 630lm - 2700K - CRI >98 - **dimnable**
 The base bracket is standard included and recommended for optimal stability.
LED included - Floor -   

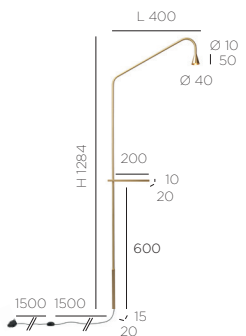
AUSTERE-TABLE



With EU plug	HVTA 1003	HVTA 1002	HVTA 1001		580€
With EU plug				HVTA 1004	690€
With UK plug*	HVTA 1003UK	HVTA 1002UK	HVTA 1001UK		580€
With UK plug*				HVTA 1004UK	690€
With US plug*	HVTA 1003US	HVTA 1002US	HVTA 1001US		580€
With US plug*				HVTA 1004US	690€
With AU plug*	HVTA 1003AU	HVTA 1002AU	HVTA 1001AU		580€
With AU plug*				HVTA 1004AU	690€

230V - **plugdriver with push button dimmer on cable**
 *110V-230V - **plugdriver with push button dimmer on cable**
 1 x LED array 6,2W - 350mA - 630lm - 2700K - CRI >98 - **dimnable**
LED included - Table -   

BOULY TABLE built-in



	FRAME	FRAME	FRAME	FRAME	RETAIL PRICE VAT. EXCL.
	●	○	●	○	
BOWW 4202					301€
BOWW 4201					
BOWW 4203					
BOWW 4209					338€

230V - **plugdriver with switch on cable**
 1 x 4 LED 0.96W - 350mA - 456lm - 2700K (on demand 6000K) - CRI >93
LED included - Table -

BOULY TABLE

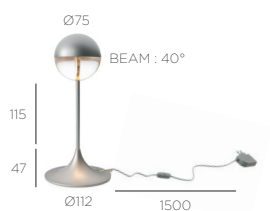

BOWW 5202					375€
BOWW 5201					
BOWW 5203					
BOWW 5209					411€

230V - **plugdriver with switch on cable**
 1 x 4 LED 0.96W - 350mA - 456lm - 2700K (on demand 6000K) - CRI >93
LED included - Table -

FLEX LENGTH

	FRAME FLEX	FRAME FLEX	FRAME FLEX	FRAME FLEX	RETAIL PRICE VAT. EXCL.
	● ●	○ ○	● ●	○ ○	

SCAR-LED TABLE built-in

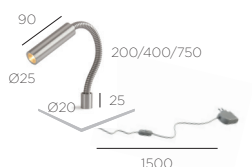

L 200		SCAR 2836◆	SCAR 2736◆	SCAR 2936◆	SCAR 2536◆		219€
L 400		SCAR 2866◆	SCAR 2766◆	SCAR 2966◆	SCAR 2566◆		224€
L 750		SCAR 2876◆	SCAR 2776◆	SCAR 2976◆	SCAR 2576◆		234€

230V - **plugdriver with switch on cable**
 1 x LED 0.96W - 350mA - 114lm - 2700K (on demand 6000K) - CRI >93
 ◆ Choose beam: N=narrow 10° or M=medium 25° or W=wide 40°
LED included - Table -

SCAR-LED TABLE

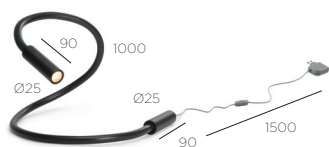

L 1000		SCAR 2851◆	SCAR 2852◆	SCAR 2850◆	SCAR 2853◆		240€
--------	--	------------	------------	------------	------------	--	------

230V - **plugdriver with switch on cable**
 1 x LED 0.96W - 350mA - 114lm - 2700K (on demand 6000K) - CRI >93
 ◆ Choose beam: N=narrow 10° or M=medium 25° or W=wide 40°
LED included - Table -

Wall/Ceiling



2THIRTY

2THIRTY C1	10
2THIRTY CH2	10
2THIRTY CV2	11
2THIRTY W1	12
2THIRTY W1 PLUG	12
2THIRTY WH2	13
2THIRTY WV2	14
2THIRTY WV2 PLUG	15



AUSTERE-WALL

AUSTERE-Wall plug	26
AUSTERE-Wall built-in	26
AUSTERE-Wall built-in touch	26



AUSTERE-CEILING

AUSTERE-CEILING 1Y	15
AUSTERE-CEILING 1X	15
AUSTERE-CEILING 1+	15



BOULY W/C

BOULY W/C	27
BOULY W/C D+B	27



AUSTERE-ELEMENTS

AUSTERE-ELEMENTS rods & straps	17
AUSTERE-ELEMENTS connectors	18
AUSTERE-ELEMENTS connectors with light-element	18
AUSTERE-ELEMENTS connectors with powercord	19
AUSTERE-ELEMENTS connectors with light-element & powercord	20
AUSTERE-ELEMENTS required drivers	21
AUSTERE-ELEMENTS mounting options	21
AUSTERE-ELEMENTS configurations	22



CODE 1 / CODE 2

CODE 1	27
CODE 1 LED	28
CODE 2	28
CODE 2 LED	28



CODE W

CODE W	29
CODE W LED	29

Wall/Ceiling



KWA-KWA

KWA-KWA 1F ROUND	30
KWA-KWA 1F SQUARE	30
KWA-KWA 1F +B ROUND	30
KWA-KWA 1FT ROUNDED LED	30
KWA-KWA 1FT RECTANGULAR LED	31
KWA-KWA 2FT ROUNDED LED	31
KWA-KWA 2FT RECTANGULAR LED	31
KWA-KWA 4FT ROUNDED LED	31
KWA-KWA 6FT ROUNDED LED	31



PIN-UP

PIN-UP 1 ROUND LED	34
PIN-UP 1 SQUARE LED	34
PIN-UP 2 LED	34
PIN-UP 4 LED	34
PIN-UP 6 LED	34



SCAR-LED

SCAR-LED 1FD built-in 45 (no-dim)	38
SCAR-LED 1FD built-in 45 (dim)	38
SCAR-LED 1FD built-in 60 (no-dim)	38
SCAR-LED 1FD built-in 60 (dim)	38
SCAR-LED 1FDS built-in 60 (no-dim)	38
SCAR-LED 1FDS built-in 60 (dim)	39
SCAR-LED 1FD built-in 95 (no-dim)	39
SCAR-LED 1FD built-in 95 (dim)	39
SCAR-LED 1FDS built-in 95 (no-dim)	39
SCAR-LED 1FDS built-in 95 (dim)	39
SCAR-LED 1FD built-up (no-dim)	40
SCAR-LED 1FDS built-up (no-dim)	40
SCAR-LED 1FDS built-up plug (no-dim)	40



LIPPS W/C

LIPPS 200 W/C	32
LIPPS 300 W/C	32
LIPPS 600 W/C	32



R5 UP

R51 UP GU5.3 LED	35
R52 UP GU5.3 LED	35
R54 UP GU5.3 LED	35
R51 UP GU10	35
R52 UP GU10	35
R54 UP GU10	36
R51 UP LED	36
R52 UP LED	36
R54 UP LED	36



SCAR-LITE

SCAR-LITE 1FD built-in (no-dim)	40
SCAR-LITE 1FD built-in (dim)	40
SCAR-LITE 1FDS built-in (no-dim)	40
SCAR-LITE 1FDS built-in (dim)	41
SCAR-LITE 1FDS built-up (no-dim)	41
SCAR-LITE 1FDS built-up (dim)	41
SCAR-LITE 1FDS built-up plug (no-dim)	41
SCAR-LITE 1FDS built-up plug (dim)	41
SCAR-LITE USB built-up	41



MINI-PI UP

MINI-PI 1 UP	32
MINI-PI 1 UP ROUND	33
MINI-PI 2 UP	33
MINI-PI 3 UP	33



R07 / R70 UP

R07 UP	37
R70 UP	37



SIRENS W/C

SIRENS W/C diffuser glass	42
SIRENS W/C mirror	42
SIRENS W/C frosted glass	
big mirror + edge mirror	42
SIRENS W/C frosted glass	
small mirror + edge mirror	42
SIRENS W/C frosted glass + edge mirror	42



NAGA

NAGA	33
------	----



R110 / R111 UP

R110 UP G53 HALO	37
R110 UP G53 LED	37
R111 UP G53 HALO	37
R111 UP G53 LED	37

RING	ROD	FRAME	SWIVEL	RETAIL PRICE VAT. EXCL.
	●	●	●	

2Thirty C1



●	THC 12223	◆	390€
●	THC 17223	◆	390€
●	THC 18223	◆	390€

230V (110V on demand)

1 x LED module 10W - 230V - 1000lm - 2700K - CRI >90 - **TRIAC dimmable**

◆ Choose beam: N=narrow 12° or M=medium 24° or W=wide 40°

Optional ring with honeycomb: see below

LED included - Ceiling -

OPTIONAL RING + HONEYCOMB FOR 2THIRTY



●	TH 200RH	35€
●	TH 700RH	35€
●	TH 800RH	35€

2Thirty C1 + honeycomb



●	THC 12223H	◆	410€
●	THC 17223H	◆	410€
●	THC 18223H	◆	410€

230V (110V on demand)

1 x LED module 10W - 230V - 1000lm - 2700K - CRI >90 - **TRIAC dimmable**

◆ Choose beam: N=narrow 12° or M=medium 24° or W=wide 40°

Optional ring without honeycomb: see below

LED included - Ceiling -

OPTIONAL RING FOR 2THIRTY



●	TH 200R	23€
●	TH 700R	23€
●	TH 800R	23€

2Thirty CH2

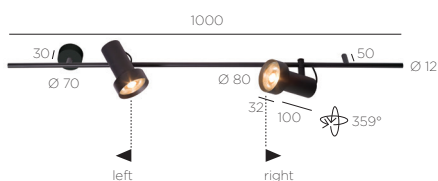

●	THP 22223	◀▶	765€
●	THP 27223	◀▶	765€
●	THP 28223	◀▶	765€

230V (110V on demand)

2 x LED module 10W - 230V - 2 x 1000lm - 2700K - CRI >90 - **TRIAC dimmable**

◀ = Choose beam left lightsource: N=narrow 12° or M=medium 24° or W=wide 40°

▶ = Choose beam right lightsource: N=narrow 12° or M=medium 24° or W=wide 40°

Optional ring with honeycomb: see below

LED included - Ceiling -

OPTIONAL RING + HONEYCOMB FOR 2THIRTY



●	TH 200RH	35€
●	TH 700RH	35€
●	TH 800RH	35€

RING	ROD	FRAME	SWIVEL	RETAIL PRICE VAT. EXCL.
	●	●	●	

2Thirty CH2 + honeycomb

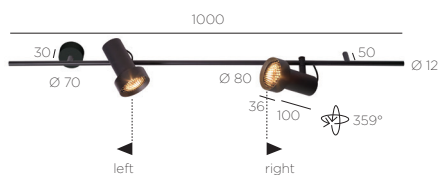

●	THP 22223H	◄►	805€
●	THP 27223H	◄►	805€
●	THP 28223H	◄►	805€

230V (110V on demand)

2 x LED module 10W - 230V - 2 x 1000lm - 2700K - CRI >90 - **TRIAC dimmable**

◄ = Choose beam left lightsource: N=narrow 12° or M=medium 24° or W=wide 40°

► = Choose beam right lightsource: N=narrow 12° or M=medium 24° or W=wide 40°

Optional ring without honeycomb: see below

LED included - Ceiling -

OPTIONAL RING FOR 2THIRTY



●	TH 200R		23€
●	TH 700R		23€
●	TH 800R		23€

2Thirty CV2

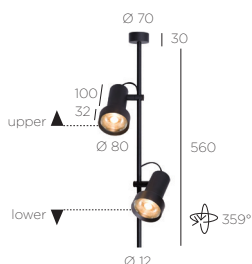

●	THC 22223	▲▼	675€
●	THC 27223	▲▼	675€
●	THC 28223	▲▼	675€

230V (110V on demand)

2 x LED module 10W - 230V - 2 x 1000lm - 2700K - CRI >90 - **TRIAC dimmable**

▲ = Choose beam upper lightsource: N=narrow 12° or M=medium 24° or W=wide 40°

▼ = Choose beam lower lightsource: N=narrow 12° or M=medium 24° or W=wide 40°

Optional ring with honeycomb: see below

LED included - Ceiling -

OPTIONAL RING + HONEYCOMB FOR 2THIRTY



●	TH 200RH		35€
●	TH 700RH		35€
●	TH 800RH		35€

2Thirty CV2 + honeycomb

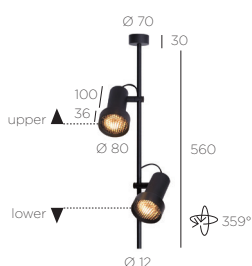

●	THC 22223H	▲▼	715€
●	THC 27223H	▲▼	715€
●	THC 28223H	▲▼	715€

230V (110V on demand)

2 x LED module 10W - 230V - 2 x 1000lm - 2700K - CRI >90 - **TRIAC dimmable**

▲ = Choose beam upper lightsource: N=narrow 12° or M=medium 24° or W=wide 40°

▼ = Choose beam lower lightsource: N=narrow 12° or M=medium 24° or W=wide 40°

Optional ring without honeycomb: see below

LED included - Ceiling -

OPTIONAL RING FOR 2THIRTY



●	TH 200R		23€
●	TH 700R		23€
●	TH 800R		23€

RING	ROD	FRAME	SWIVEL	RETAIL PRICE VAT. EXCL.
	●	●	●	

2Thirty W1



●	THW 12223	◆	390€
●	THW 17223	◆	390€
●	THW 18223	◆	390€

230V (110V on demand) - **ON/OFF on armature**
1 x LED module 10W - 230V - 1000lm - 2700K - CRI >90 - **TRIAC dimmable**

◆ **Choose beam:** N=narrow 12° or M=medium 24° or W=wide 40°

Optional ring with honeycomb: see below

LED included - Wall -

OPTIONAL RING + HONEYCOMB FOR 2THIRTY



●	TH 200RH	35€
●	TH 700RH	35€
●	TH 800RH	35€

2Thirty W1 + honeycomb



●	THW 12223H	◆	410€
●	THW 17223H	◆	410€
●	THW 18223H	◆	410€

230V (110V on demand) - **ON/OFF on armature**
1 x LED module 10W - 230V - 1000lm - 2700K - CRI >90 - **TRIAC dimmable**

◆ **Choose beam:** N=narrow 12° or M=medium 24° or W=wide 40°

Optional ring without honeycomb: see below

LED included - Wall -

OPTIONAL RING FOR 2THIRTY



●	TH 200R	23€
●	TH 700R	23€
●	TH 800R	23€

2Thirty W1 plug



●	THW 12223EU	◆	430€
●	THW 17223EU	◆	430€
●	THW 18223EU	◆	430€

230V (110V on demand) - **EU-plug** - **ON/OFF on armature**
1 x LED module 10W - 230V - 1000lm - 2700K - CRI >90 - **TRIAC dimmable**

◆ **Choose beam:** N=narrow 12° or M=medium 24° or W=wide 40°

Optional ring with honeycomb: see below

LED included - Wall -

OPTIONAL RING + HONEYCOMB FOR 2THIRTY



●	TH 200RH	35€
●	TH 700RH	35€
●	TH 800RH	35€

RING	ROD	FRAME	SWIVEL	RETAIL PRICE VAT. EXCL.
	●	●	●	

2Thirty W1 plug + honeycomb



●	THW 12223EUH	450€
●	THW 17223EUH	450€
●	THW 18223EUH	450€

230V (110V on demand) - **EU-plug** - **ON/OFF on armature**
 1 x LED module 10W - 230V - 1000lm - 2700K - CRI >90 - **TRIAC dimmable**

◆ **Choose beam:** N=narrow 12° or M=medium 24° or W=wide 40°

Optional ring without honeycomb: see below

LED included - Wall -

OPTIONAL RING FOR 2THIRTY



●	TH 200R	23€
●	TH 700R	23€
●	TH 800R	23€

2Thirty WH2

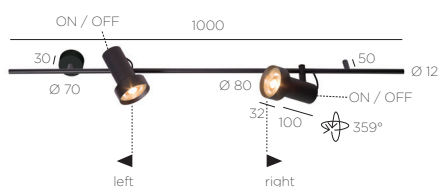

●	THH 22223	◀▶	765€
●	THH 27223	◀▶	765€
●	THH 28223	◀▶	765€

230V (110V on demand) - **ON/OFF on armature**

2 x LED module 10W - 230V - 2 x 1000lm - 2700K - CRI >90 - **TRIAC dimmable**

◀ = **Choose beam left lightsource:** N=narrow 12° or M=medium 24° or W=wide 40°

▶ = **Choose beam right lightsource:** N=narrow 12° or M=medium 24° or W=wide 40°

Optional ring with honeycomb: see below

LED included - Wall -

OPTIONAL RING + HONEYCOMB FOR 2THIRTY



●	TH 200RH	35€
●	TH 700RH	35€
●	TH 800RH	35€

2Thirty WH2 + honeycomb

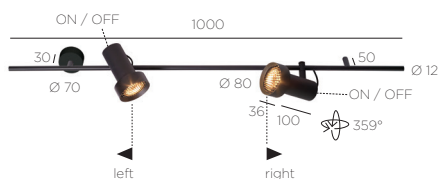

●	THH 22223H	◀▶	805€
●	THH 27223H	◀▶	805€
●	THH 28223H	◀▶	805€

230V (110V on demand) - **ON/OFF on armature**

2 x LED module 10W - 230V - 2 x 1000lm - 2700K - CRI >90 - **TRIAC dimmable**

◀ = **Choose beam left lightsource:** N=narrow 12° or M=medium 24° or W=wide 40°

▶ = **Choose beam right lightsource:** N=narrow 12° or M=medium 24° or W=wide 40°

Optional ring without honeycomb: see below

LED included - Wall -

OPTIONAL RING FOR 2THIRTY



●	TH 200R	23€
●	TH 700R	23€
●	TH 800R	23€

RING	ROD	FRAME	SWIVEL	RETAIL PRICE VAT. EXCL.
	●	●	●	

2Thirty WV2

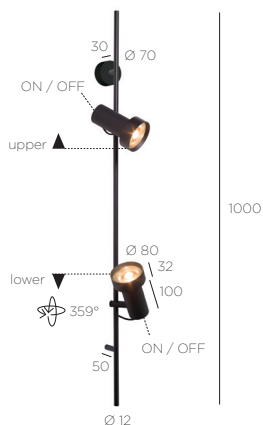

●	THR 22223 ▲▼	765€
●	THR 27223 ▲▼	765€
●	THR 28223 ▲▼	765€

230V (110V on demand) - **ON/OFF on armature**

2 x LED module 10W - 230V - 2 x 1000lm - 2700K - CRI >90 - **TRIAC dimmable**

▲ = Choose beam upper lightsource: N=narrow 12° or M=medium 24° or W=wide 40°

▼ = Choose beam lower lightsource: N=narrow 12° or M=medium 24° or W=wide 40°

Optional ring with honeycomb: see below

LED included - Wall -

OPTIONAL RING + HONEYCOMB FOR 2THIRTY



●	TH 200RH	35€
●	TH 700RH	35€
●	TH 800RH	35€

2Thirty WV2 + honeycomb

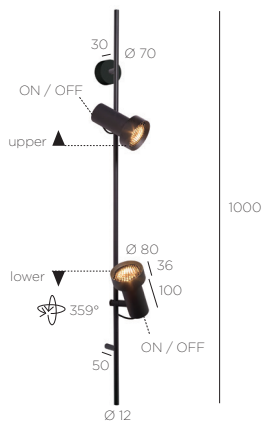

●	THR 22223H ▲▼	805€
●	THR 27223H ▲▼	805€
●	THR 28223H ▲▼	805€

230V (110V on demand) - **ON/OFF on armature**

2 x LED module 10W - 230V - 2 x 1000lm - 2700K - CRI >90 - **TRIAC dimmable**

▲ = Choose beam upper lightsource: N=narrow 12° or M=medium 24° or W=wide 40°

▼ = Choose beam lower lightsource: N=narrow 12° or M=medium 24° or W=wide 40°

Optional ring without honeycomb: see below

LED included - Wall -

OPTIONAL RING FOR 2THIRTY



●	TH 200R	23€
●	TH 700R	23€
●	TH 800R	23€

RING	ROD	FRAME	SWIVEL	RETAIL PRICE VAT. EXCL.
	●	●	●	

2Thirty WV2 plug



●	THRP 22223 ▲▼	765€
●	THRP 27223 ▲▼	765€
●	THRP 28223 ▲▼	765€

230V (110V on demand) - **ON/OFF on armature - plug on cable**
 2 x LED module 10W - 230V - 2 x 1000lm - 2700K - CRI >90 - **TRIAC dimmable**

▲ = Choose beam upper lightsource: N=narrow 12° or M=medium 24° or W=wide 40°
 ▼ = Choose beam lower lightsource: N=narrow 12° or M=medium 24° or W=wide 40°

Optional ring with honeycomb: see below
LED included - Wall -

OPTIONAL RING + HONEYCOMB FOR 2THIRTY



●	TH 200RH	35€
●	TH 700RH	35€
●	TH 800RH	35€

2Thirty WV2 plug + honeycomb



●	THRP 22223H ▲▼	805€
●	THRP 27223H ▲▼	805€
●	THRP 28223H ▲▼	805€

230V (110V on demand) - **ON/OFF on armature - plug on cable**
 2 x LED module 10W - 230V - 2 x 1000lm - 2700K - CRI >90 - **TRIAC dimmable**

▲ = Choose beam upper lightsource: N=narrow 12° or M=medium 24° or W=wide 40°
 ▼ = Choose beam lower lightsource: N=narrow 12° or M=medium 24° or W=wide 40°

Optional ring without honeycomb: see below
LED included - Wall -

OPTIONAL RING FOR 2THIRTY



●	TH 200R	23€
●	TH 700R	23€
●	TH 800R	23€

AUSTERE-CEILING 1Y



LENGTH	FRAME	FRAME	RETAIL PRICE VAT. EXCL.
3x 250mm	1Y C 2033	1Y C 2022	1.131€
3x 500mm	1Y C 5033	1Y C 5022	1.162€
3x 750mm	1Y C 7033	1Y C 7022	1.193€

350mA - driver + cover/canopy required* see below

3 x LED array 6,2W - 350mA - 3 x 630lm - 2700K - CRI >98 - dimmable

Each arm on the same level has the same length: 3 x 250 mm = Ø 590 mm / 3 x 500 mm = Ø 1090 mm / 3 x 750 mm = Ø 1590 mm.

LED included - Ceiling - CE IP50 eco

AUSTERE-CEILING 1X



4x 250mm	1X C 2033	1X C 2022	1.430€
4x 500mm	1X C 5033	1X C 5022	1.471€
4x 750mm	1X C 7033	1X C 7022	1.512€

350mA - driver + cover/canopy required* see below

4 x LED array 6,2W - 350mA - 4 x 630lm - 2700K - CRI >98 - dimmable

Each arm on the same level has the same length: 4 x 250 mm = L 516 mm W 316 mm / 4 x 500 mm = L 949 mm W 565 mm / 4 x 750 mm = L 1382 mm W 815 mm.

LED included - Ceiling - CE IP50 eco

AUSTERE-CEILING 1+



4x 250mm	1+ C 2033	1+ C 2022	1.409€
4x 500mm	1+ C 5033	1+ C 5022	1.451€
4x 750mm	1+ C 7033	1+ C 7022	1.492€

350mA - driver + cover/canopy required* see below

4 x LED array 6,2W - 350mA - 4 x 630lm - 2700K - CRI >98 - dimmable

Each arm on the same level has the same length: 4 x 250 mm = Ø 590 mm / 4 x 500 mm = Ø 1090 mm / 4 x 750 mm = Ø 1590 mm.

LED included - Ceiling - CE IP50 eco

*REQUIRED FOR REMOTE MOUNTING: COVER/CANOPY

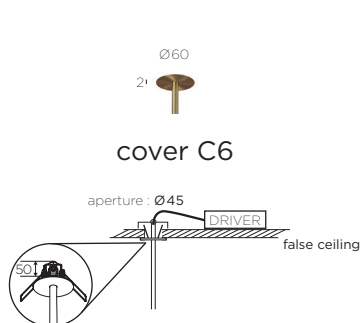

cover C6

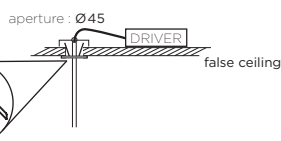

cover C8

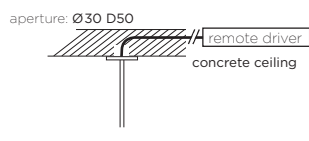

canopy B10

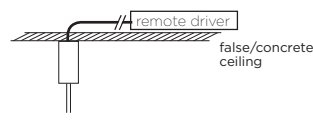

●	21CO 3300	68€
●	21CO 2200	68€
○	21CO 1100	68€

! NOTE for Austere-Ceiling + C6 :
 If the thickness of the false ceiling is 15mm,
 the total length of the chandelier with
 cover C6 will be 148mm.

21CO 8003	80€
21CO 8002	80€
21CO 8001	80€

! NOTE for Austere-Ceiling + C8 :
 the total length of the chandelier with
 cover C8 will be 176mm.

21CP 3333	222€
21CP 2222	222€
21CP 1111	222€

! NOTE for Austere-Ceiling + B10 :
 the total length of the chandelier with
 canopy B10 will be 276mm.

*REQUIRED FOR REMOTE MOUNTING: DRIVER

DEVICE	DIM.	DRIVER	NET PRICE	DEVICE	DIM.	DRIVER	NET PRICE
1 x	NO	N 50W *	24€	1 x	1-10 PU DA PU	D 80WP* D 80WD*	37€ 42€

* driver only fits through cutout hole of fixture with C6.
 min. depth for driver in false ceiling: 280mm

**For warranty use only Trizo21® supplied LED drivers as mentioned.
 For all specs and techs about drivers, see www.trizo21.com/drivers**

AUSTERE-ELEMENTS

Design your own unique composition with our app:
www.elements-configurator.trizo21.com

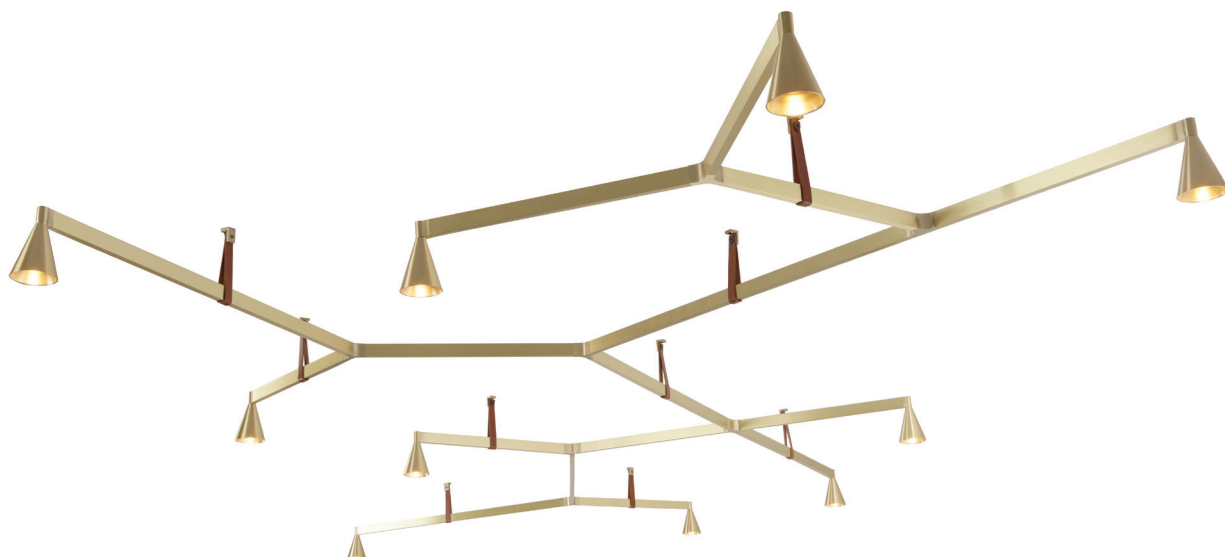

LENGTH	FRAME	FRAME	RETAIL PRICE VAT: EXCL.
	●	●	

AUSTERE-ELEMENTS RODS

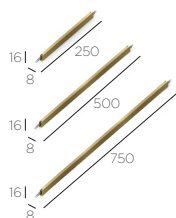

L 250	HEL R 2003	HEL R 2002	102€
L 500	HEL R 5003	HEL R 5002	112€
L 750	HEL R 7003	HEL R 7002	123€

FRAME LEATHER	FRAME LEATHER	FRAME LEATHER	FRAME LEATHER	RETAIL PRICE VAT: EXCL.
● ●	● ●	● ●	● ●	

AUSTERE-ELEMENTS STRAPS H93



HEL S 0933	HEL S 0923	HEL S 0932	HEL S 0922	71€
------------	------------	------------	------------	-----

LENGTH	FRAME LEATHER STEELCABLE	FRAME LEATHER STEELCABLE	FRAME LEATHER STEELCABLE	FRAME LEATHER STEELCABLE	RETAIL PRICE VAT: EXCL.
	● ● ●	● ● ●	● ● ●	● ● ●	

AUSTERE-ELEMENTS STRAPS Steelcable



L 500	HEL S 0533	HEL S 0523	HEL S 0532	HEL S 0522	115€
L 1000	HEL S 1033	HEL S 1023	HEL S 1032	HEL S 1022	118€
L 2000	HEL S 2033	HEL S 2023	HEL S 2032	HEL S 2022	124€
L 3000	HEL S 3033	HEL S 3023	HEL S 3032	HEL S 3022	130€
L 4000	HEL S 4033	HEL S 4023	HEL S 4032	HEL S 4022	136€

FRAME



FRAME



RETAIL PRICE
VAT. EXCL.

AUSTERE-ELEMENTS CONNECTORS

END connector

16 |  HEL**E** 0003 HEL**E** 0002 | 70€

- connector

16 |  HEL**-** 0003 HEL**-** 0002 | 105€

+ connector

16 |  HEL**+** 0003 HEL**+** 0002 | 135€

Y connector

16 |  HEL**Y** 0003 HEL**Y** 0002 | 135€

T connector

16 |  HEL**T** 0003 HEL**T** 0002 | 130€

X connector

16 |  HEL**X** 0003 HEL**X** 0002 | 140€

90° connector

16 |  HEL**90** 0003 HEL**90** 0002 | 125€

120° connector

16 |  HEL**120** 0003 HEL**120** 0002 | 125€

AUSTERE-ELEMENTS CONNECTORS with light-element

END connector with light-element

16 |  HEL**E** L003 HEL**E** L002 | 200€
50 | Ø 40

- connector with light-element

16 |  HEL**-** L003 HEL**-** L002 | 235€
50 | Ø 40

+ connector with light-element

16 |  HEL**+** L003 HEL**+** L002 | 265€
50 | Ø 40

Y connector with light-element

16 |  HEL**Y** L003 HEL**Y** L002 | 265€
50 | Ø 40

T connector with light-element

16 |  HEL**T** L003 HEL**T** L002 | 260€
50 | Ø 40

X connector with light-element

16 |  HEL**X** L003 HEL**X** L002 | 270€
50 | Ø 40

90° connector with light-element

16 |  HEL**90** L003 HEL**90** L002 | 255€
50 | Ø 40

120° connector with light-element

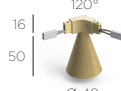
16 |  HEL**120** L003 HEL**120** L002 | 255€
50 | Ø 40

350mA - **driver + base/cover/canopy required*** - see p21
1 x LED array 6,2W - 350mA - 630lm - 2700K - CRI >98 - **dimmable**
LED included - Ceiling -   

POWERCORD
LENGTH

FRAME
POWERCORD

FRAME
POWERCORD

FRAME
POWERCORD

FRAME
POWERCORD

RETAIL PRICE
VAT. EXCL.



AUSTERE-ELEMENTS CONNECTORS with powercord

END connector with powercord



POWERCORD LENGTH	FRAME	POWERCORD	FRAME	POWERCORD	FRAME	POWERCORD	RETAIL PRICE VAT. EXCL.
L 500	HECE	0523	HECE	0522	HECE	0513	125€
L 1000	HECE	0123	HECE	0122	HECE	0113	130€
L 2000	HECE	0223	HECE	0222	HECE	0213	140€
L 3000	HECE	0323	HECE	0322	HECE	0313	150€
L 4000	HECE	0423	HECE	0422	HECE	0413	160€

- connector with powercord



L 500	HEC-	0523	HEC-	0522	HEC-	0513	160€
L 1000	HEC-	0123	HEC-	0122	HEC-	0113	165€
L 2000	HEC-	0223	HEC-	0222	HEC-	0213	175€
L 3000	HEC-	0323	HEC-	0322	HEC-	0313	185€
L 4000	HEC-	0423	HEC-	0422	HEC-	0413	195€

+ connector with powercord



L 500	HEC+	0523	HEC+	0522	HEC+	0513	190€
L 1000	HEC+	0123	HEC+	0122	HEC+	0113	195€
L 2000	HEC+	0223	HEC+	0222	HEC+	0213	205€
L 3000	HEC+	0323	HEC+	0322	HEC+	0313	215€
L 4000	HEC+	0423	HEC+	0422	HEC+	0413	225€

Y connector with powercord



L 500	HECY	0523	HECY	0522	HECY	0513	190€
L 1000	HECY	0123	HECY	0122	HECY	0113	195€
L 2000	HECY	0223	HECY	0222	HECY	0213	205€
L 3000	HECY	0323	HECY	0322	HECY	0313	215€
L 4000	HECY	0423	HECY	0422	HECY	0413	225€

T connector with powercord



L 500	HECT	0523	HECT	0522	HECT	0513	185€
L 1000	HECT	0123	HECT	0122	HECT	0113	190€
L 2000	HECT	0223	HECT	0222	HECT	0213	200€
L 3000	HECT	0323	HECT	0322	HECT	0313	210€
L 4000	HECT	0423	HECT	0422	HECT	0413	220€

X connector with powercord



L 500	HECX	0523	HECX	0522	HECX	0513	195€
L 1000	HECX	0123	HECX	0122	HECX	0113	200€
L 2000	HECX	0223	HECX	0222	HECX	0213	210€
L 3000	HECX	0323	HECX	0322	HECX	0313	220€
L 4000	HECX	0423	HECX	0422	HECX	0413	230€

90° connector with powercord

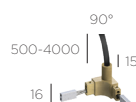

L 500	HEC90	0523	HEC90	0522	HEC90	0513	180€
L 1000	HEC90	0123	HEC90	0122	HEC90	0113	185€
L 2000	HEC90	0223	HEC90	0222	HEC90	0213	195€
L 3000	HEC90	0323	HEC90	0322	HEC90	0313	205€
L 4000	HEC90	0423	HEC90	0422	HEC90	0413	215€

120° connector with powercord

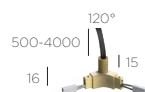

L 500	HEC120	0523	HEC120	0522	HEC120	0513	180€
L 1000	HEC120	0123	HEC120	0122	HEC120	0113	185€
L 2000	HEC120	0223	HEC120	0222	HEC120	0213	195€
L 3000	HEC120	0323	HEC120	0322	HEC120	0313	205€
L 4000	HEC120	0423	HEC120	0422	HEC120	0413	215€

POWERCORD
LENGTH

FRAME
POWERCORD

FRAME
POWERCORD

FRAME
POWERCORD

FRAME
POWERCORD

RETAIL PRICE
VAT. EXCL.



AUSTERE-ELEMENTS CONNECTORS with light-element & powercord

- connector with light-element & powercord

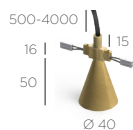

POWERCORD LENGTH	FRAME	POWERCORD	FRAME	POWERCORD	FRAME	POWERCORD	RETAIL PRICE VAT. EXCL.
L 500	HEC-	L523	HEC-	L522	HEC-	L513	290€
L 1000	HEC-	L123	HEC-	L122	HEC-	L113	295€
L 2000	HEC-	L223	HEC-	L222	HEC-	L213	305€
L 3000	HEC-	L323	HEC-	L322	HEC-	L313	315€
L 4000	HEC-	L423	HEC-	L422	HEC-	L413	325€

+ connector with light-element & powercord

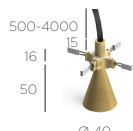

L 500	HEC+	L523	HEC+	L522	HEC+	L513	320€
L 1000	HEC+	L123	HEC+	L122	HEC+	L113	325€
L 2000	HEC+	L223	HEC+	L222	HEC+	L213	335€
L 3000	HEC+	L323	HEC+	L322	HEC+	L313	345€
L 4000	HEC+	L423	HEC+	L422	HEC+	L413	355€

Y connector with light-element & powercord

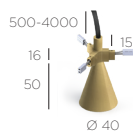

L 500	HECY	L523	HECY	L522	HECY	L513	320€
L 1000	HECY	L123	HECY	L122	HECY	L113	325€
L 2000	HECY	L223	HECY	L222	HECY	L213	335€
L 3000	HECY	L323	HECY	L322	HECY	L313	345€
L 4000	HECY	L423	HECY	L422	HECY	L413	355€

T connector with light-element & powercord

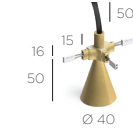

L 500	HECT	L523	HECT	L522	HECT	L513	315€
L 1000	HECT	L123	HECT	L122	HECT	L113	320€
L 2000	HECT	L223	HECT	L222	HECT	L213	330€
L 3000	HECT	L323	HECT	L322	HECT	L313	340€
L 4000	HECT	L423	HECT	L422	HECT	L413	350€

X connector with light-element & powercord

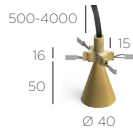

L 500	HECX	L523	HECX	L522	HECX	L513	325€
L 1000	HECX	L123	HECX	L122	HECX	L113	330€
L 2000	HECX	L223	HECX	L222	HECX	L213	340€
L 3000	HECX	L323	HECX	L322	HECX	L313	350€
L 4000	HECX	L423	HECX	L422	HECX	L413	360€

90° connector with light-element & powercord

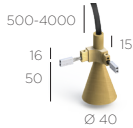

L 500	HEC90	L523	HEC90	L522	HEC90	L513	310€
L 1000	HEC90	L123	HEC90	L122	HEC90	L113	315€
L 2000	HEC90	L223	HEC90	L222	HEC90	L213	325€
L 3000	HEC90	L323	HEC90	L322	HEC90	L313	335€
L 4000	HEC90	L423	HEC90	L422	HEC90	L413	345€



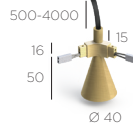

120° connector with light-element & powercord



L 500	HEC120	L523	HEC120	L522	HEC120	L513	310€
L 1000	HEC120	L123	HEC120	L122	HEC120	L113	315€
L 2000	HEC120	L223	HEC120	L222	HEC120	L213	325€
L 3000	HEC120	L323	HEC120	L322	HEC120	L313	335€
L 4000	HEC120	L423	HEC120	L422	HEC120	L413	345€

350mA - **driver + base/cover/canopy required*** - see p.21
 1 x LED array 6,2W - 350mA - 630lm - 2700K - CRI >98 - **dimmable**
LED included - Ceiling -

***REQUIRED FOR REMOTE MOUNTING: COVER/CANOPY**

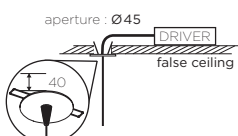
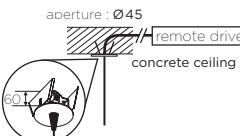
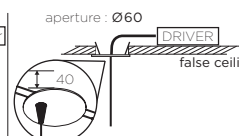
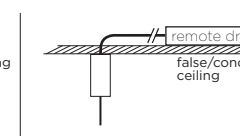
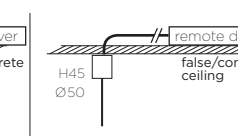
				
cover C6	cover C6	cover C9	canopy B10	canopy B45
				
<ul style="list-style-type: none"> ● 21CO 0003 68€ ● 21CO 0002 68€ ○ 21CO 0001 68€ 	<ul style="list-style-type: none"> ● 21CO 0013 84€ ● 21CO 0012 84€ ○ 21CO 0011 84€ 	<ul style="list-style-type: none"> ○ 21CO 2000 33€ ○ 21CO 1000 33€ 	<ul style="list-style-type: none"> ○ 21CP 3003 222€ ○ 21CP 2002 222€ ○ 21CP 1001 222€ 	<ul style="list-style-type: none"> ○ 21CP 5000 130€ ○ 21CP 4000 130€

***REQUIRED FOR REMOTE MOUNTING: DRIVER**

DEVICE	DIM.	DRIVER	NET PRICE	DEVICE	DIM.	DRIVER	NET PRICE
2-7 x	NO	N 50W	24€	3-12 x	H0 PU	D 80WP	37€
3-12 x	NO	N 80W	27€	3-12 x	DA PU	D 80WD	42€

*driver only fits through cutout hole of fixture with C6, min. depth for driver in false ceiling: 280mm

For warranty use only Trizo21® supplied LED drivers as mentioned.
 For all specs and techs about drivers, see www.trizo21.com/drivers

***REQUIRED FOR SURFACE MOUNTING: BASE (DRIVER INCL.)**

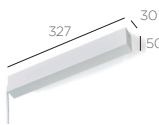
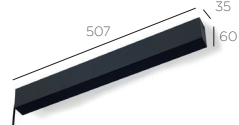
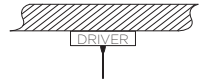
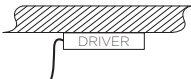
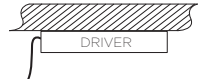
		
base B20	base B32	base B50
		
<ul style="list-style-type: none"> ● H0 PU BCPU 2402 255€ ○ H0 PU BCPU 2401 255€ ● DA PU BCDA 2402 255€ ○ DA PU BCDA 2401 255€ 	<ul style="list-style-type: none"> NO BNDN 0822 365€ NO BNDN 0811 365€ 	<ul style="list-style-type: none"> ● H0 PU BDPU 0822 445€ ○ H0 PU BDPU 0811 445€ ● DA PU BDPA 0822 470€ ○ DA PU BDPA 0811 470€
110V-230V - driver included in base + casambi possible Max. 6 light-elements	230V - driver included in base	230V - driver included in base + casambi possible

Example: AUSTERE-ELEMENTS Configuration °1

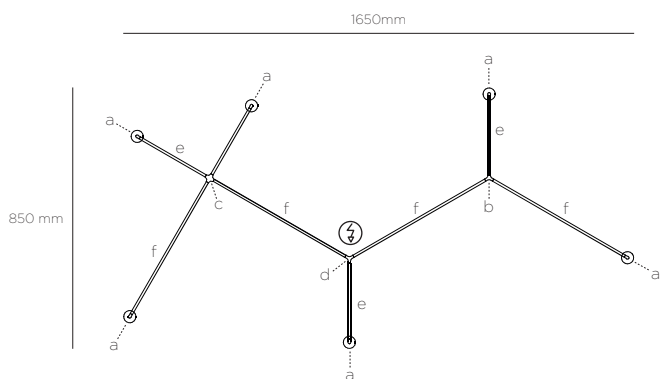

- a: 6x END connector with light-element
 - b: 1x Y connector
 - c: 1x + connector
 - d: 1x Y connector with powercord L500
 - e: 4x AUSTERE-ELEMENTS rods L250
 - f: 4x AUSTERE-ELEMENTS rods L500
 - 8x AUSTERE-ELEMENTS straps H93
- (driver + base/cover/canopy excl. see p.21)

FRAME	POWERCORD	LEATHER	FRAME	POWERCORD	LEATHER	FRAME	POWERCORD	LEATHER	FRAME	POWERCORD	LEATHER	RETAIL PRICE VAT. EXCL.
●	●	●	●	●	●	●	○	●	●	○	●	3.084€

short code to order this Austere-Elements configuration °1:
 (driver + base/cover/canopy excl. see p.21)

ELEM 1323 ELEM 1222 ELEM 1313 ELEM 1212 | 3.084€

350mA - driver + base/cover/canopy required* see p.21
 6 x LED array 6,2W - 350mA - 6 x 630lm - 2700K - CRI >98 - dimmable
 LED included - Ceiling -

Example: AUSTERE-ELEMENTS Configuration °2

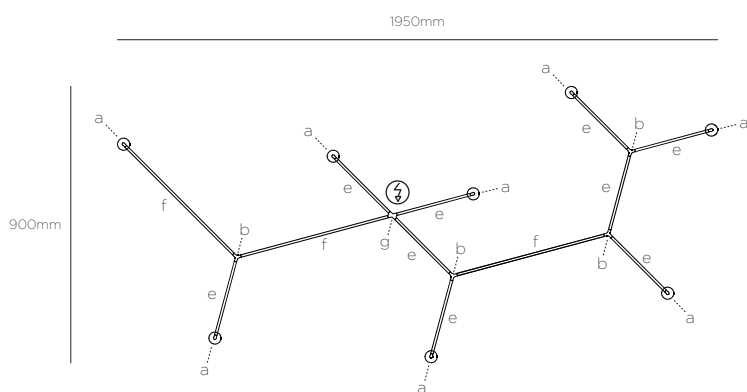

- a: 8x END connector with light-element
 - b: 4x Y connector
 - g: 1x X connector with powercord L500
 - e: 9x AUSTERE-ELEMENTS rods L250
 - f: 3x AUSTERE-ELEMENTS rods L500
 - 12x AUSTERE-ELEMENTS straps H93
- (driver + base/cover/canopy excl. see p.21)

FRAME	POWERCORD	LEATHER	FRAME	POWERCORD	LEATHER	FRAME	POWERCORD	LEATHER	FRAME	POWERCORD	LEATHER	RETAIL PRICE VAT. EXCL.
●	●	●	●	●	●	●	○	●	●	○	●	4.441€

short code to order this Austere-Elements configuration °2:
 (driver + base/cover/canopy excl. see p.21)

ELEM 2323 ELEM 2222 ELEM 2313 ELEM 2212 | 4.441€

350mA - driver + base/cover/canopy required* see p.21
 8 x LED array 6,2W - 350mA - 8 x 630lm - 2700K - CRI >98 - dimmable
 LED included - Ceiling -

Example: AUSTERE-ELEMENTS Configuration °3

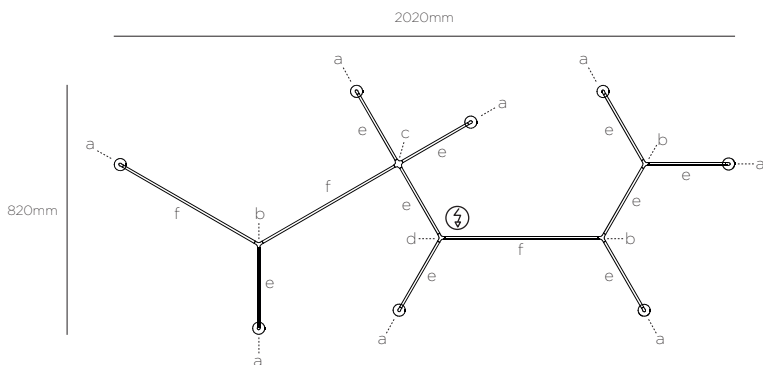

- a: 8x END connector with light-element
- b: 3x Y connector
- c: 1x + connector
- d: 1x Y connector with powercord L500
- e: 9x AUSTERE-ELEMENTS rods L250
- f: 3x AUSTERE-ELEMENTS rods L500

12x AUSTERE-ELEMENTS straps H93
(driver + base/cover/canopy excl. see p.21)

FRAME	POWERCORD	LEATHER	FRAME	POWERCORD	LEATHER	FRAME	POWERCORD	LEATHER	FRAME	POWERCORD	LEATHER	RETAIL PRICE VAT: EXCL.
●	●	●	●	●	●	●	○	●	●	○	●	4.436€

short code to order this Austere-Elements configuration °3:
(driver + base/cover/canopy excl. see p.21)

ELEM 3323 ELEM 3222 ELEM 3313 ELEM 3212 | 4.436€

350mA - driver + base/cover/canopy required* see p.21
8 x LED array 6,2W - 350mA - 8 x 630lm - 2700K - CRI >98 - dimmable
LED included - Ceiling -

Example: AUSTERE-ELEMENTS Configuration °4

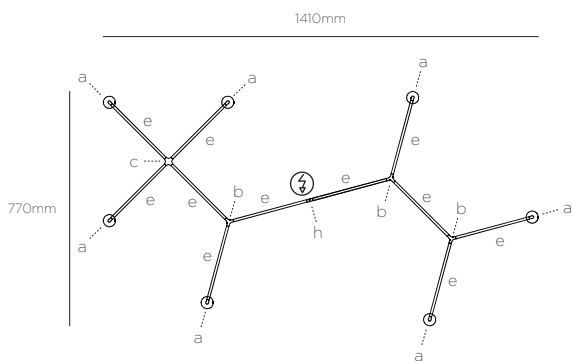

- a: 7x END connector with light-element
- b: 3x Y connector
- c: 1x + connector
- h: 1x - connector with powercord L500
- e: 11x AUSTERE-ELEMENTS rods L250
- 11x AUSTERE-ELEMENTS straps H93

(driver + base/cover/canopy excl. see p.21)

FRAME	POWERCORD	LEATHER	FRAME	POWERCORD	LEATHER	FRAME	POWERCORD	LEATHER	FRAME	POWERCORD	LEATHER	RETAIL PRICE VAT: EXCL.
●	●	●	●	●	●	●	○	●	●	○	●	4.003€

short code to order this Austere-Elements configuration °4:
(driver + base/cover/canopy excl. see p.21)

ELEM 4323 ELEM 4222 ELEM 4313 ELEM 4212 | 4.003€

350mA - driver + base/cover/canopy required* see p.21
7 x LED array 6,2W - 350mA - 7 x 630lm - 2700K - CRI >98 - dimmable
LED included - Ceiling -

Example: AUSTERE-ELEMENTS Configuration °5

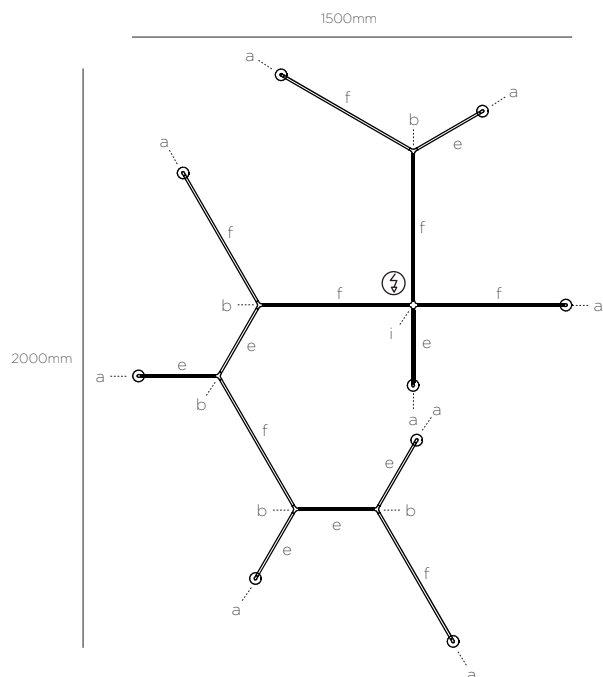

- a: 9x END connector with light-element
 - b: 5x Y connector
 - i: 1x + connector with powercord L500
 - e: 7x AUSTERE-ELEMENTS rods L250
 - f: 7x AUSTERE-ELEMENTS rods L500
 - 15x AUSTERE-ELEMENTS straps H93
- (driver + base/cover/canopy excl. see p.21)

FRAME	POWERCORD	LEATHER	FRAME	POWERCORD	LEATHER	FRAME	POWERCORD	LEATHER	FRAME	POWERCORD	LEATHER	RETAIL PRICE VAT: EXCL.
●	●	●	●	●	●	●	○	●	●	○	●	ELEM 5323
●	●	●	●	●	●	●	○	●	●	○	●	ELEM 5222
●	○	●	●	○	●	●	○	●	●	○	●	ELEM 5313
●	○	●	●	○	●	●	○	●	●	○	●	ELEM 5212
												5.228€

short code to order this Austere-Elements configuration °5:
 (driver + base/cover/canopy excl. see p.21)

350mA - driver + base/cover/canopy required* see p.21
 9 x LED array 6,2W - 350mA - 9 x 630lm - 2700K - CRI >98 - dimmable
 LED included - Ceiling -

Example: AUSTERE-ELEMENTS Configuration °6

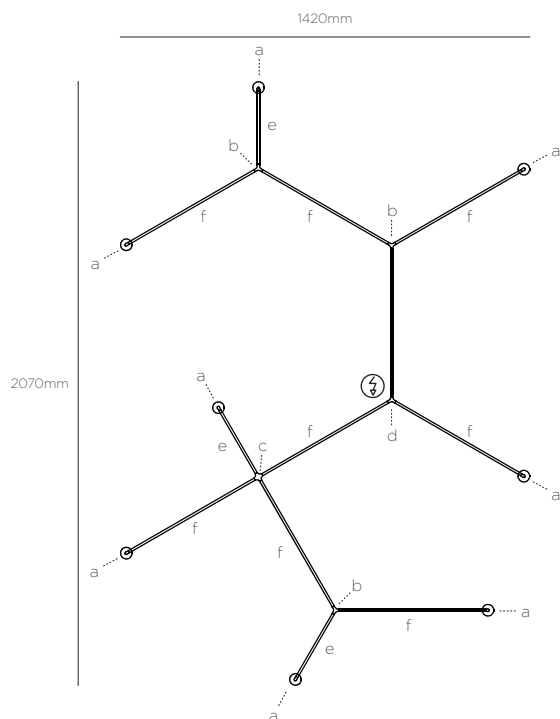

- a: 8x END connector with light-element
 - b: 3x Y connector
 - c: 1x + connector
 - d: 1x Y connector with powercord L500
 - e: 3x AUSTERE-ELEMENTS rods L250
 - f: 9x AUSTERE-ELEMENTS rods L500
 - 12x AUSTERE-ELEMENTS straps H93
- (driver + base/cover/canopy excl. see p.21)

FRAME	POWERCORD	LEATHER	FRAME	POWERCORD	LEATHER	FRAME	POWERCORD	LEATHER	FRAME	POWERCORD	LEATHER	RETAIL PRICE VAT: EXCL.
●	●	●	●	●	●	●	○	●	●	○	●	ELEM 6323
●	●	●	●	●	●	●	○	●	●	○	●	ELEM 6222
●	○	●	●	○	●	●	○	●	●	○	●	ELEM 6313
●	○	●	●	○	●	●	○	●	●	○	●	ELEM 6212
												4.496€

short code to order this Austere-Elements configuration °6:
 (driver + base/cover/canopy excl. see p.21)

350mA - driver + base/cover/canopy required* see p.21
 8 x LED array 6,2W - 350mA - 8 x 630lm - 2700K - CRI >98 - dimmable
 LED included - Ceiling -

Example: AUSTERE-ELEMENTS Configuration °7

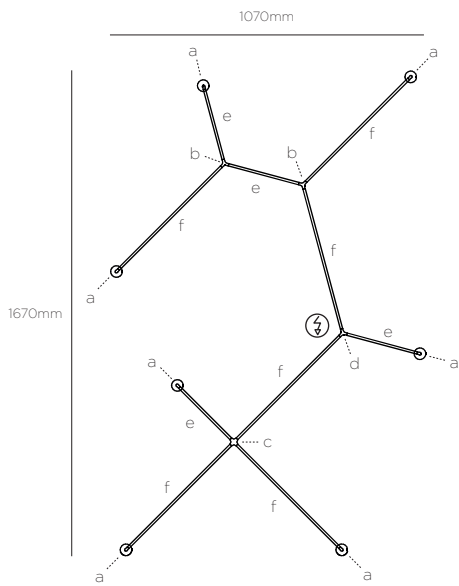

- a: 7x **END** connector with light-element
 - b: 2x **Y** connector
 - c: 1x **+** connector
 - d: 1x **Y** connector with powercord L500
 - e: 4x **AUSTERE-ELEMENTS** rods L250
 - f: 6x **AUSTERE-ELEMENTS** rods L500
 - 10x **AUSTERE-ELEMENTS** straps H93
- (driver + base/cover/canopy excl. see p.21)

FRAME	POWERCORD	LEATHER	FRAME	POWERCORD	LEATHER	FRAME	POWERCORD	LEATHER	FRAME	POWERCORD	LEATHER	RETAIL PRICE VAT. EXCL.
●	●	●	●	●	●	●	○	●	●	○	●	

short code to order this Austere-Elements configuration °7:
 (driver + base/cover/canopy excl. see p.21)

ELEM 7323 ELEM 7222 ELEM 7313 ELEM 7212 | 3.785€

350mA - **driver + base/cover/canopy required*** see p.21
 7 x LED array 6,2W - 350mA - 7 x 630lm - 2700K - CRI >98 - **dimmable**
LED included - Ceiling -

Example: AUSTERE-ELEMENTS Configuration °8

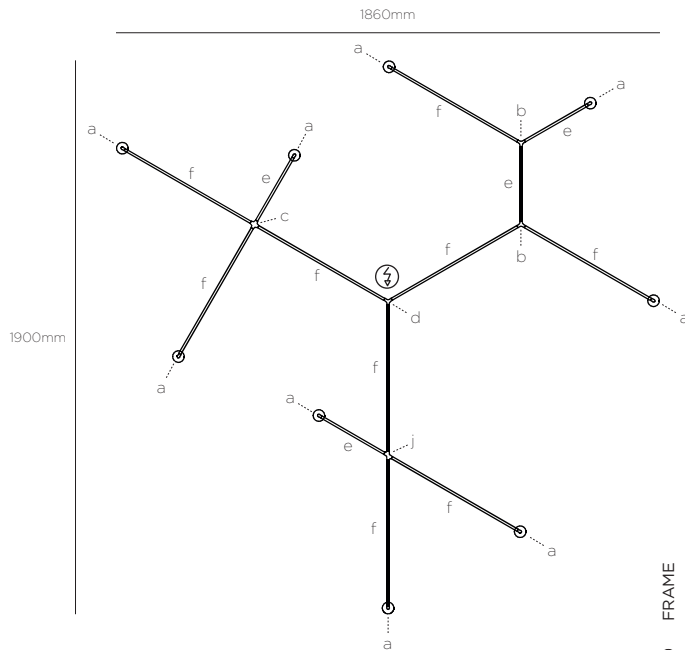

- a: 9x **END** connector with light-element
 - b: 2x **Y** connector
 - c: 1x **+** connector
 - j: 1x **X** connector
 - d: 1x **Y** connector with powercord L500
 - e: 4x **AUSTERE-ELEMENTS** rods L250
 - f: 9x **AUSTERE-ELEMENTS** rods L500
 - 13x **AUSTERE-ELEMENTS** straps H93
- (driver + base/cover/canopy excl. see p.21)

FRAME	POWERCORD	LEATHER	FRAME	POWERCORD	LEATHER	FRAME	POWERCORD	LEATHER	FRAME	POWERCORD	LEATHER	RETAIL PRICE VAT. EXCL.
●	●	●	●	●	●	●	○	●	●	○	●	

short code to order this Austere-Elements configuration °8:
 (driver + base/cover/canopy excl. see p.21)

ELEM 8323 ELEM 8222 ELEM 8313 ELEM 8212 | 4.874€

350mA - **driver + base/cover/canopy required*** see p.21
 9 x LED array 6,2W - 350mA - 9 x 630lm - 2700K - CRI >98 - **dimmable**
LED included - Ceiling -

FRAME	FRAME	FRAME	FRAME	RETAIL PRICE VAT. EXCL.
●	●	○	●	

AUSTERE-WALL plug

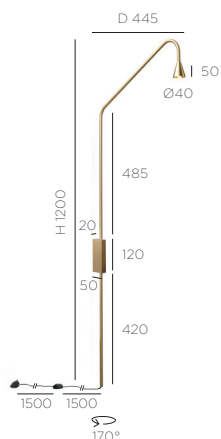

With EU plug	HVWA 1003	HVWA 1002	HVWA 1001		572€
With EU plug				HVWA 1004	675€
With UK plug*	HVWA 1003UK	HVWA 1002UK	HVWA 1001UK		572€
With UK plug*				HVWA 1004UK	675€
With US plug*	HVWA 1003US	HVWA 1002US	HVWA 1001US		572€
With US plug*				HVWA 1004US	675€
With AU plug*	HVWA 1003AU	HVWA 1002AU	HVWA 1001AU		572€
With AU plug*				HVWA 1004AU	675€

230V - plugdriver with push button dimmer on cable
 *110V-230V - plugdriver with push button dimmer on cable
 1 x LED array 6,2W - 350mA - 630lm - 2700K - CRI >98 - dimmable
LED included - Wall -

AUSTERE-WALL built-in

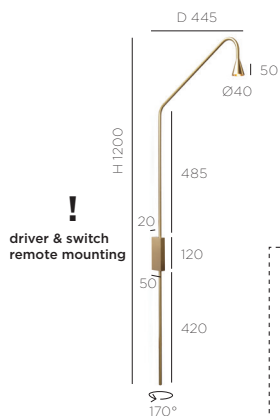

HVWB 1003	HVWB 1002	HVWB 1001		572€
			HVWB 1004	675€

350mA - driver required (remote mounting) see below
 1 x LED array 6,2W - 350mA - 630lm - 2700K - CRI >98 - dimmable
LED included - Wall -

REQUIRED DRIVER (REMOTE MOUNTING)

DEVICE	DIM.	DRIVER	NET PRICE	DEVICE	DIM.	DRIVER	NET PRICE
1 x	NO	N 6W	11,20€	1-2 x	1-10 PU	D 15WP*	20,65€
	LC	D 10WT	14,65€		DA	D 15WDA*	22,60€
2 x	LC	D 18WT	16,95€	2-6 x	1-10 PU	D 40WP*	44,65€
					1-10 PU DA	D 40WD*	46,65€

driver does not fit through cutout hole of fixture
 *110V-230V

For warranty use only Trizo21® supplied LED drivers as mentioned.
 For all specs and techs about drivers, see www.trizo21.com/drivers

AUSTERE-WALL built-in touch

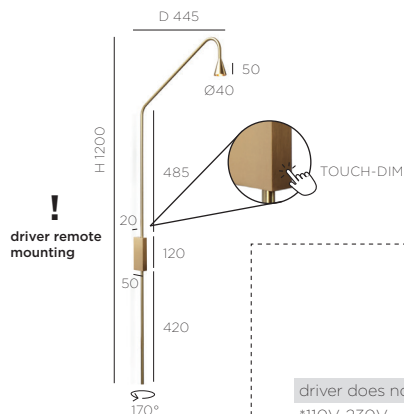

HVWT 1003	HVWT 1002	HVWT 1001		638€
			HVWT 1004	741€

350mA - driver required (remote mounting) see below - TOUCH dimmable
 1 x LED array 6,2W - 350mA - 630lm - 2700K - CRI >98 - dimmable
LED included - Wall -

REQUIRED DRIVER (REMOTE MOUNTING)

DEVICE	DIM.	DRIVER	NET PRICE
1-2 x	TOUCH-DIM	D 15WP*	20,65€

driver does not fit through cutout hole of fixture
 *110V-230V

For warranty use only Trizo21® supplied LED drivers as mentioned.
 For all specs and techs about drivers, see www.trizo21.com/drivers

BOULY W/C

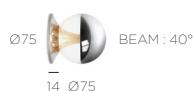

	FRAME	FRAME	FRAME	FRAME	RETAIL PRICE VAT. EXCL.
	●	○	●	○	
BOWW 1002					305€
BOWW 1001					
BOWW 1003					
BOWW 1009					342€

350mA - **driver required (remote mounting)** see below
 1 x 4 LED 0.96W - 350mA - 456lm - 2700K (on demand 6000K) - CRI >93 - **dimmable**
 depth for driver in ceiling : min. 75 mm
LED included - Wall & ceiling -

REQUIRED DRIVER (REMOTE MOUNTING)							
DEVICE	DIM.	DRIVER	NET PRICE	DEVICE	DIM.	DRIVER	NET PRICE
1 x	NO 1-10 C	N 4W D 6WP D 6WI	7,90€ 11,20€ 14,65€	1-3 x	1-10 DA 1-10	PU DA PU	20,65€ 22,60€ 44,65€ 46,65€
driver does not fit through cutout hole of fixture *110V-230V				For warranty use only Trizo21® supplied LED drivers as mentioned. For all specs and techs about drivers, see www.trizo21.com/drivers			

BOULY W/C D+B



BOWW 1102	BOWW 1101	BOWW 1103		368€
			BOWW 1109	406€

230V - **driver included in base - non-dimmable**
 1 x 4 LED 0.96W - 350mA - 456lm - 2700K (on demand 6000K) - CRI >93
LED included - Wall & ceiling -

CODE 1



VOLT	FRAME	FRAME	FRAME	FRAME	FRAME	RETAIL PRICE VAT. EXCL.
	●	○	●	●	○	
230V	CODE 2001	CODE 1001				126€
230V			CODE 3001	CODE 7001		137€
230V					CODE 9001	164€
12V	CODE 2121	CODE 1121				126€
12V			CODE 3121	CODE 7121		137€
12V					CODE 9121	164€

230V - GU10 - 1 x QPAR16 max. 50W or 1 x GU10 LED
 12V - **transformer excluded** GU5.3 - 1 x QR-CBC51 HALO (only alu reflector, no cool beam) max. 50W or 1 x GU5.3 LED
Bulb excluded - Ceiling -

OPTIONAL COVER FOR CODE 1

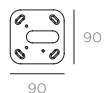

ACDE 2010	ACDE 1010			31€
		ACDE 3010	ACDE 7010	34€
			ACDE 9010	39€

VOLT	DIM	FRAME	FRAME	FRAME	FRAME	FRAME	RETAIL PRICE VAT. EXCL.
		●	○	●	●	○	

CODE 1 LED



NO	CODE 2105◆	CODE 1105◆					286€
NO			CODE 3105◆	CODE 7105◆			296€
NO					CODE 9105◆		322€
C	CODE 2405◆	CODE 1605◆					296€
C			CODE 3605◆	CODE 7605◆			306€
C					CODE 9605◆		332€

230V - **driver included in base - non-dimmable or IGBT dimmable**
 1 x 4 LED 0.96W - 350mA - 456lm - 2700K (on demand 6000K) - CRI >93
 ◆ Choose beam: N=narrow 10° or M=medium 25° or W=wide 40°
LED included - Ceiling -

OPTIONAL COVER FOR CODE 1 LED



ACDE 2010	ACDE 1010					31€
		ACDE 3010	ACDE 7010			34€
				ACDE 9010		39€

CODE 2



230V	CODE 2002	CODE 1002				154€
230V			CODE 3002	CODE 7002		175€
230V					CODE 9002	219€
12V	CODE 2122	CODE 1122				154€
12V			CODE 3122	CODE 7122		175€
12V					CODE 9122	219€

◆ 230V - GUI0 - 2 x QPAR16 max. 50W or 2 x GUI0 LED
 ◆ 12V - **transformer excluded** - GU5.3 - 2 x HALO QR-CBC51 (only alu reflector, no cool beam) max. 50W or 2 x GU5.3 LED
Bulbs excluded - Ceiling -

CODE 2 LED



LC	CODE 2207◆	CODE 1207◆				465€
LC			CODE 3207◆	CODE 7207◆		485€
LC					CODE 9207◆	526€

230V - **driver included in base - TRIAC/IGBT dimmable**
 1 x 8 LED 0.96W - 350mA - 912lm - 2700K (on demand 6000K) - CRI >93
 ◆ Choose beam: N=narrow 10° or M=medium 25° or W=wide 40°
LED included - Ceiling -

VOLT	FRAME	FRAME	FRAME	FRAME	FRAME	RETAIL PRICE VAT. EXCL.
	●	○	●	●	○	
CODE W 	230V - G9 HALO	CODE 2005	CODE 1005			132€
	230V - G9 HALO			CODE 3005	CODE 7005	143€
	230V - G9 HALO					180€
					CODE 9005	180€
12V - GY6.35 HALO	CODE 2125	CODE 1125				132€
12V - GY6.35 HALO			CODE 3125	CODE 7125		143€
12V - GY6.35 HALO					CODE 9125	180€
230V - G9 LED	CODE L2005	CODE L1005				132€
230V - G9 LED			CODE L3005	CODE L7005		143€
230V - G9 LED					CODE L9005	180€

◇ 230V G9 - 1 x HALO QT14 max. 60W or 1 x G9 LED (max. Ø19, max. L 62mm)
 ◇ 12V - **transformer excluded** - GY6.35 - 1 x QT12 max. 50W
Bulb excluded - Wall -

OPTIONAL COVER FOR CODE W



ACDE 2005	ACDE 1005			31€
		ACDE 3005	ACDE 7005	34€
			ACDE 9005	39€

CODE W LED

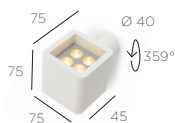

1 side	CODE 2555	CODE 1555		286€	
2 sides	CODE 2666	CODE 1666		444€	
1 side			CODE 3555	CODE 7555	296€
2 sides			CODE 3666	CODE 7666	454€
1 side				CODE 9555	332€
2 sides				CODE 9666	490€

350mA - **driver required (remote mounting)** see below
 1 lighting side : 1 x 4 LED 0.96W - 350mA - 456lm - 2700K (on demand 6000K) - CRI >93 - **dimnable**
 2 lighting sides : 2 x 4 LED 0.96W - 350mA - 2 x 456lm - 2700K (on demand 6000K) - CRI >93 - **dimnable**
 ◆ Choose beam: N=narrow 10° or M=medium 25° or W=wide 40°
LED included - Wall -

REQUIRED DRIVER (REMOTE MOUNTING)									
DEVICE	DIM.	DRIVER	NET PRICE	DEVICE	DIM.	DRIVER	NET PRICE		
1 x	1 side	NO		1 x	2 sides	NO	N 12W**	18,65€	
		I-10 PU	N 4W			7,90€	LC	D 10WT	14,65€
		C	D 6WP			11,20€	I-10 PU	D 15WP*	20,65€
1-2 x	1 side	NO	N 12W**	18,65€	1-4 x	2 sides	DA	D 15WDA*	22,60€
		I-10 PU	D 15WP*	20,65€			I-10 PU	D 40 WP*	44,65€
1-3 x	1 side	DA	D 15WDA*	22,60€	1-10 PU DA		D 40 WD*	46,65€	
		I-10 PU	D 40WP*	44,65€					
2-8 x	1 side	I-10 PU	D 40WD*	46,65€					
		I-10 PU DA							

driver does not fit through cutout hole of fixture
 *110V-230V **IP65
 ***driver fits behind optional cover for CODE W LED

**For warranty use only Trizo21® supplied LED drivers as mentioned.
 For all specs and techs about drivers, see www.trizo21.com/drivers**

OPTIONAL COVER FOR CODE W LED



ACDE 2005	ACDE 1005			31€
		ACDE 3005	ACDE 7005	34€
			ACDE 9005	39€

DIM	FLEX LENGTH	FRAME	RETAIL PRICE VAT. EXCL.
-----	-------------	-------	----------------------------

KWA-KWA 1F ROUND

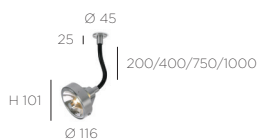

L 200	21IN 3201	133€
L 400	21IN 3241	139€
L 750*	21IN 3271*	148€
L 1000*	21IN 3261*	155€

12V - transformer excluded

G53 - 1 x R111 HALO max. 75W or R111 LED

Bulb excluded - Wall & ceiling (*only ceiling) -

OPTIONAL COVER KWA-KWA 1F ROUND



21AC 3200	34€
-----------	-----

KWA-KWA 1F SQUARE

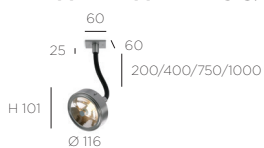

L 200	21IN 4201	137€
L 400	21IN 4241	142€
L 750*	21IN 4271*	153€
L 1000*	21IN 4261*	159€

12V - transformer excluded

G53 - 1 x R111 HALO max. 75W or R111 LED

Bulb excluded - Wall & ceiling (*only ceiling) -

OPTIONAL COVER KWA-KWA 1F SQUARE



21AC 3203	34€
-----------	-----

KWA-KWA 1F +B ROUND



L 200	21SO 3201	152€
L 400	21SO 3241	158€
L 750*	21SO 3271*	167€
L 1000*	21SO 3251*	173€

12V - transformer excluded

G53 - 1 x R111 HALO max. 75W or R111 LED

Bulb excluded - Wall & ceiling (*only ceiling) -

KWA-KWA 1FT ROUNDED LED

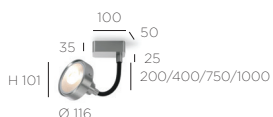

L 200	21SO L3314	266€
L 400	21SO L3343	271€
L 750*	21SO L3373*	281€
L 1000*	21SO L3353*	288€

230V - transformer included in base - IGBT dimmable

G53 - 1 x R111 LED max. 60W

Bulb excluded - Wall & ceiling (*only ceiling) -

KWA-KWA 1FT RECTANGULAR LED

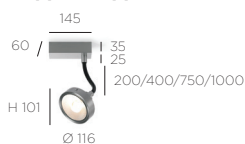

DIM	FLEX LENGTH	FRAME	RETAIL PRICE VAT. EXCL.
LC	L 200	21SO L3214	253€
LC	L 400	21SO L3243	258€
LC	L 750*	21SO L3273*	267€
LC	L 1000*	21SO L3253*	273€

230V - transformer included in base - TRIAC/IGBT dimmable

G53 - 1 x R111 LED max. 60W

Bulb excluded - Wall & ceiling (*only ceiling) -

KWA-KWA 2FT ROUNDED LED

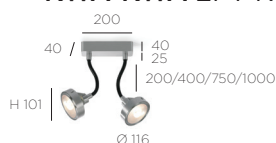

LC	L 200	21SO L3402	400€
LC	L 400	21SO L3442	410€
LC	L 750*	21SO L3472*	430€
LC	L 1000*	21SO L3452*	443€

230V - transformer included in base - TRIAC/IGBT dimmable

G53 - 2 x R111 LED max. 45W

Bulbs excluded - Wall & ceiling (*only ceiling) -

KWA-KWA 2FT RECTANGULAR LED

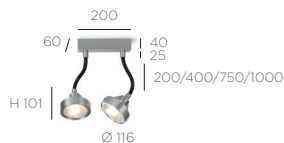

LC	L 200	21SO L3202	377€
LC	L 400	21SO L3242	389€
LC	L 750*	21SO L3272*	408€
LC	L 1000*	21SO L3252*	422€

230V - transformer included in base - TRIAC/IGBT dimmable

G53 - 2 x R111 LED max. 45W

Bulbs excluded - Wall & ceiling (*only ceiling) -

KWA-KWA 4FT ROUNDED LED



LC	L 200	21SO L3404	881€
LC	L 400	21SO L3444	902€
LC	L 750*	21SO L3474*	942€
LC	L 1000*	21SO L3454*	968€

230V - transformer included in base - TRIAC/IGBT dimmable

G53 - 4 x R111 LED max. 45W

Bulbs excluded - Wall & ceiling (*only ceiling) -

KWA-KWA 6FT ROUNDED LED

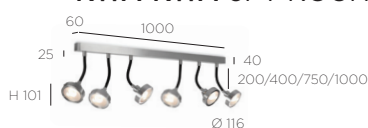

LC	L 200	21SO L3406	1.189€
LC	L 400	21SO L3446	1.208€
LC	L 750*	21SO L3476*	1.268€
LC	L 1000*	21SO L3456*	1.274€

230V - transformer included in base - TRIAC/IGBT dimmable

G53 - 6 x R111 LED max. 45W

Bulbs excluded - Wall & ceiling (*only ceiling) -

DIM	FRAME	INTERIOR	FRAME	INTERIOR	FRAME	INTERIOR	FRAME	INTERIOR	FRAME	INTERIOR	FRAME	INTERIOR	RETAIL PRICE	VAT. EXCL.
-----	-------	----------	-------	----------	-------	----------	-------	----------	-------	----------	-------	----------	--------------	------------

LIPPS 200 W/C



DIM	LC	PU	DA	LIPR 2227	LIPR 2228	LIPR 2221	LIPR 2217	LIPR 2218	LIPR 2211	430€
				LIPR 2027	LIPR 2028	LIPR 2021	LIPR 2017	LIPR 2018	LIPR 2011	430€
				LIPR 2527	LIPR 2528	LIPR 2521	LIPR 2517	LIPR 2518	LIPR 2511	445€

110V-230V - driver included in base - TRIAC/IGBT, 1-10V, PUSH-DIM or DALI dimmable
 LED array 6W - 700mA - 500lm - 2700K - CRI >90
LED included - Wall & ceiling - CE IP30 eco

LIPPS 300 W/C



DIM	LC	PU	DA	LIPR 3327	LIPR 3328	LIPR 3321	LIPR 3317	LIPR 3318	LIPR 3311	550€
				LIPR 3027 <td>LIPR 3028 <td>LIPR 3021 <td>LIPR 3017 <td>LIPR 3018 <td>LIPR 3011</td> <td>550€</td> </td></td></td></td>	LIPR 3028 <td>LIPR 3021 <td>LIPR 3017 <td>LIPR 3018 <td>LIPR 3011</td> <td>550€</td> </td></td></td>	LIPR 3021 <td>LIPR 3017 <td>LIPR 3018 <td>LIPR 3011</td> <td>550€</td> </td></td>	LIPR 3017 <td>LIPR 3018 <td>LIPR 3011</td> <td>550€</td> </td>	LIPR 3018 <td>LIPR 3011</td> <td>550€</td>	LIPR 3011	550€
				LIPR 3527 <td>LIPR 3528 <td>LIPR 3521 <td>LIPR 3517 <td>LIPR 3518 <td>LIPR 3511</td> <td>565€</td> </td></td></td></td>	LIPR 3528 <td>LIPR 3521 <td>LIPR 3517 <td>LIPR 3518 <td>LIPR 3511</td> <td>565€</td> </td></td></td>	LIPR 3521 <td>LIPR 3517 <td>LIPR 3518 <td>LIPR 3511</td> <td>565€</td> </td></td>	LIPR 3517 <td>LIPR 3518 <td>LIPR 3511</td> <td>565€</td> </td>	LIPR 3518 <td>LIPR 3511</td> <td>565€</td>	LIPR 3511	565€

110V-230V - driver included in base - TRIAC/IGBT, 1-10V, PUSH-DIM or DALI dimmable
 LED array 9W - 350mA - 750lm - 2700K - CRI >90
LED included - Wall & ceiling - CE IP30 eco

LIPPS 600 W/C



DIM	LC	PU	DA	LIPR 6627	LIPR 6628	LIPR 6621	LIPR 6617	LIPR 6618	LIPR 6611	995€
				LIPR 6027 <td>LIPR 6028 <td>LIPR 6021 <td>LIPR 6017 <td>LIPR 6018 <td>LIPR 6011</td> <td>995€</td> </td></td></td></td>	LIPR 6028 <td>LIPR 6021 <td>LIPR 6017 <td>LIPR 6018 <td>LIPR 6011</td> <td>995€</td> </td></td></td>	LIPR 6021 <td>LIPR 6017 <td>LIPR 6018 <td>LIPR 6011</td> <td>995€</td> </td></td>	LIPR 6017 <td>LIPR 6018 <td>LIPR 6011</td> <td>995€</td> </td>	LIPR 6018 <td>LIPR 6011</td> <td>995€</td>	LIPR 6011	995€
				LIPR 6527 <td>LIPR 6528 <td>LIPR 6521 <td>LIPR 6517 <td>LIPR 6518 <td>LIPR 6511</td> <td>1010€</td> </td></td></td></td>	LIPR 6528 <td>LIPR 6521 <td>LIPR 6517 <td>LIPR 6518 <td>LIPR 6511</td> <td>1010€</td> </td></td></td>	LIPR 6521 <td>LIPR 6517 <td>LIPR 6518 <td>LIPR 6511</td> <td>1010€</td> </td></td>	LIPR 6517 <td>LIPR 6518 <td>LIPR 6511</td> <td>1010€</td> </td>	LIPR 6518 <td>LIPR 6511</td> <td>1010€</td>	LIPR 6511	1010€

110V-230V - driver included in base - TRIAC/IGBT, 1-10V, PUSH-DIM or DALI dimmable
 LED array 36W - 500mA - 3000lm - 2700K - CRI >90
LED included - Wall & ceiling - CE IP30 eco

DIM	FRAME	FRAME	FRAME	RETAIL PRICE	VAT. EXCL.
-----	-------	-------	-------	--------------	------------

MINI-PI 1 UP

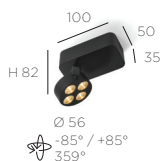

DIM	NO	C	MIPU 1225	MIPU 1115	MIPU 1445	295€
			MIPU 1525	MIPU 1615	MIPU 1945	305€

230V - driver included in base - non-dimmable or IGBT dimmable
 1 X 4 LED 0.96W - 350mA - 456lm - 2700K (on demand 6000K) - CRI >93
 Choose beam: N=narrow 10° or M=medium 25° or W=wide 40°
LED included - Wall & ceiling - CE IP40 eco

MINI-PI 1 UP ROUND



DIM	FRAME	FRAME	FRAME	RETAIL PRICE VAT. EXCL.
NO	●	○	●	295€
	MIPRU 1225	MIPRU 1115		

230V - driver included in base - non-dimmable
 1 X 4 LED 0.96W - 350mA - 456lm - 2700K (on demand 6000K) - CRI >93
 ♦ Choose beam: N=narrow 10° or M=medium 25° or W=wide 40°
 LED included - Wall & ceiling - CE IP40 eco

MINI-PI 2 UP

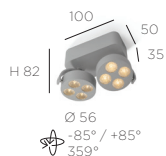

LC	●	●	●	495€
	MIPU 2225	MIPU 2115	MIPU 2445	

230V - driver included in base - TRIAC/IGBT dimmable
 2 x 4 LED 0.96W - 350mA - 2 x 456lm - 2700K (on demand 6000K) - CRI >93
 ♦ Choose beam: N=narrow 10° or M=medium 25° or W=wide 40°
 LED included - Wall & ceiling - CE IP40 eco

MINI-PI 3 UP

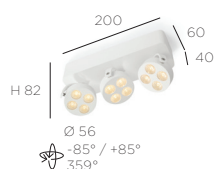

LC	●	●		670€
	MIPU 3225	MIPU 3115		
1-10 PU*	●	●		695€
	MIPU 3325	MIPU 3315		

230V - driver included in base - TRIAC/IGBT dimmable
 *110V-230V - driver included in base - 1-10V or PUSH-DIM dimmable
 3 x 4 LED 0.96W - 350mA - 3 x 456lm - 2700K (on demand 6000K) - CRI >93
 ♦ Choose beam: N=narrow 10° or M=medium 25° or W=wide 40°
 LED included - Wall & ceiling - CE IP40 eco

NAGA



RING	FRAME	FRAME	FRAME	RETAIL PRICE VAT. EXCL.
●	●	○	●	180€
●	NAGA 2112	NAGA 1112	NAGA 7112	195€
○	NAGA 2111	NAGA 1111	NAGA 7111	180€
○				195€
●	NAGA 2117	NAGA 1117	NAGA 7117	185€
●				200€
●	NAGA 2116	NAGA 1116	NAGA 7116	185€
●				200€

110V-230V - GU10 LED
 LED bulb excluded - Ceiling - CE IP20 eco

PIN-UP 1 ROUND LED



DIM	FRAME	FRAME	FRAME	FRAME	FRAME	RETAIL PRICE VAT. EXCL.
C	●	○	●	●	○	208€
				PIUP L7050		228€
					PIUP L9050	258€

230V - transformer included in base - IGBT dimmable

G53 - 1 x R111 LED max. 60W

LED bulb excluded - Wall & ceiling -

PIN-UP 1 SQUARE LED



C	PIUP L2150	PIUP L1150	PIUP L3150			241€
				PIUP L7150		234€
					PIUP L9150	263€

230V - transformer included in base - IGBT dimmable

G53 - 1 x R111 LED max. 60W

LED bulb excluded - Wall & ceiling -

PIN-UP 2 LED



LC	PIUP L2152	PIUP L1152	PIUP L3152			362€
				PIUP L7152		402€
					PIUP L9152	460€

230V - transformer included in base - TRIAC/IGBT dimmable

G53 - 2 x R111 LED max. 45W

LED bulbs excluded - Wall & ceiling -

PIN-UP 4 LED



LC	PIUP L2154	PIUP L1154	PIUP L3154			842€
----	------------	------------	------------	--	--	------

230V - transformer included in base - TRIAC/IGBT dimmable

G53 - 4 x R111 LED max. 45W

LED bulbs excluded - Wall & ceiling -

PIN-UP 6 LED

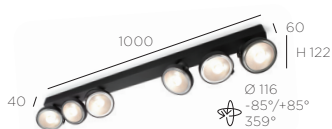

LC	PIUP L2156	PIUP L1156	PIUP L3156			1.148€
----	------------	------------	------------	--	--	--------

230V - transformer included in base - TRIAC/IGBT dimmable

G53 - 6 x R111 LED max. 45W

LED bulbs excluded - Wall & ceiling -

DIM	RING	FRAME	INTERIOR	FRAME	INTERIOR	FRAME	INTERIOR	FRAME	INTERIOR	FRAME	INTERIOR	FRAME	INTERIOR	RETAIL PRICE VAT. EXCL.
		●	●	●	○	○	●	○	○	○	○	●	●	

R51 UP GU5.3 LED



NO	●	MRUP L1222	MRUP L1122	MRUP L1212	MRUP L1112	MRUP L1242	MRUP L1142	246€
NO	○	MRUP L1229	MRUP L1129	MRUP L1219	MRUP L1119	MRUP L1249	MRUP L1149	301€
NO	●	MRUP L1224	MRUP L1124	MRUP L1214	MRUP L1114	MRUP L1244	MRUP L1144	246€
NO	○	MRUP L1221	MRUP L1121	MRUP L1211	MRUP L1111	MRUP L1241	MRUP L1141	246€

230V - transformer included in base - non-dimmable

1 x GU5.3 LED max. 20W

LED bulb excluded - Ceiling -

R52 UP GU5.3 LED



LC	●	MRUP L2222	MRUP L2122	MRUP L2212	MRUP L2112	MRUP L2242	MRUP L2142	301€
LC	○	MRUP L2229	MRUP L2129	MRUP L2219	MRUP L2119	MRUP L2249	MRUP L2149	406€
LC	●	MRUP L2224	MRUP L2124	MRUP L2214	MRUP L2114	MRUP L2244	MRUP L2144	301€
LC	○	MRUP L2221	MRUP L2121	MRUP L2211	MRUP L2111	MRUP L2241	MRUP L2141	301€

230V - transformer included in base - TRIAC/IGBT dimmable

2 x GU5.3 LED max. 20W

LED bulbs excluded - Ceiling -

R54 UP GU5.3 LED



LC	●	MRUP L4222	MRUP L4122	MRUP L4212	MRUP L4112	MRUP L4242	MRUP L4142	472€
LC	○	MRUP L4229	MRUP L4129	MRUP L4219	MRUP L4119	MRUP L4249	MRUP L4149	683€
LC	●	MRUP L4224	MRUP L4124	MRUP L4214	MRUP L4114	MRUP L4244	MRUP L4144	472€
LC	○	MRUP L4221	MRUP L4121	MRUP L4211	MRUP L4111	MRUP L4241	MRUP L4141	472€

230V - transformer included in base - TRIAC/IGBT dimmable

4 x GU5.3 LED max. 20W

LED bulbs excluded - Ceiling -

R51 UP GU10



●	MUGU 1222	MUGU 1122	MUGU 1212	MUGU 1112	MUGU 1242	MUGU 1142	226€
○	MUGU 1229	MUGU 1129	MUGU 1219	MUGU 1119	MUGU 1249	MUGU 1149	281€
●	MUGU 1224	MUGU 1124	MUGU 1214	MUGU 1114	MUGU 1244	MUGU 1144	226€
○	MUGU 1221	MUGU 1121	MUGU 1211	MUGU 1111	MUGU 1241	MUGU 1141	226€

230V

GU10 - 1 x HALO QPAR16 (alu reflector / no cool beam) max. 50W or 1 x GU10 LED max. 20W

LED bulb excluded - Ceiling -

R52 UP GU10



●	MUGU 2222	MUGU 2122	MUGU 2212	MUGU 2112	MUGU 2242	MUGU 2142	281€
○	MUGU 2229	MUGU 2129	MUGU 2219	MUGU 2119	MUGU 2249	MUGU 2149	386€
●	MUGU 2224	MUGU 2124	MUGU 2214	MUGU 2114	MUGU 2244	MUGU 2144	281€
○	MUGU 2221	MUGU 2121	MUGU 2211	MUGU 2111	MUGU 2241	MUGU 2141	281€

230V

GU10 - 2 x HALO QPAR16 (alu reflector / no cool beam) max. 50W or 2 x GU10 LED max. 20W

LED bulbs excluded - Ceiling -

DIM	RING	FRAME	INTERIOR	FRAME	INTERIOR	FRAME	INTERIOR	FRAME	INTERIOR	FRAME	INTERIOR	FRAME	INTERIOR	RETAIL PRICE	VAT. EXCL.
		●	●	●	○	○	●	○	○	●	●	●	○		

R54 UP GU10



●	MUGU 4222	MUGU 4122	MUGU 4212	MUGU 4112	MUGU 4242	MUGU 4142	432€
○	MUGU 4229	MUGU 4129	MUGU 4219	MUGU 4119	MUGU 4249	MUGU 4149	643€
●	MUGU 4224	MUGU 4124	MUGU 4214	MUGU 4114	MUGU 4244	MUGU 4144	432€
○	MUGU 4221	MUGU 4121	MUGU 4211	MUGU 4111	MUGU 4241	MUGU 4141	432€

230V

GU10 - 4 x HALO QPAR16 (alu reflector / no cool beam) max. 50W or 4 x GU10 LED max. 20W

LED bulbs excluded - Ceiling -

R51 UP LED



NO ●	MUWW 1222	MUWW 1122	MUWW 1212	MUWW 1112	MUWW 1242	MUWW 1142	350€
NO ●	MUWW 1224	MUWW 1124	MUWW 1214	MUWW 1114	MUWW 1244	MUWW 1144	350€
NO ○	MUWW 1221	MUWW 1121	MUWW 1211	MUWW 1111	MUWW 1241	MUWW 1141	350€
C ●	MUWW 1522	MUWW 1622	MUWW 1512	MUWW 1612	MUWW 1542	MUWW 1642	360€
C ●	MUWW 1524	MUWW 1624	MUWW 1514	MUWW 1614	MUWW 1544	MUWW 1644	360€
C ○	MUWW 1521	MUWW 1621	MUWW 1511	MUWW 1611	MUWW 1541	MUWW 1641	360€

230V - driver included in base - non-dimmable or IGBT dimmable

1 x 4 LED 0.96W - 350mA - 456lm - 2700K (on demand 6000K) - CRI >93

◆ Choose beam: N=narrow 10° or M=medium 25° or W=wide 40°

LED included - Ceiling -

R52 UP LED



LC ●	MUWW 2222	MUWW 2122	MUWW 2212	MUWW 2112	MUWW 2242	MUWW 2142	555€
LC ●	MUWW 2224	MUWW 2124	MUWW 2214	MUWW 2114	MUWW 2244	MUWW 2144	555€
LC ○	MUWW 2221	MUWW 2121	MUWW 2211	MUWW 2111	MUWW 2241	MUWW 2141	555€
1-10 PU ●	MUWW 2222P	MUWW 2122P	MUWW 2212P	MUWW 2112P	MUWW 2242P	MUWW 2142P	580€
1-10 PU ●	MUWW 2224P	MUWW 2124P	MUWW 2214P	MUWW 2114P	MUWW 2244P	MUWW 2144P	580€
1-10 PU ○	MUWW 2221P	MUWW 2121P	MUWW 2211P	MUWW 2111P	MUWW 2241P	MUWW 2141P	580€

230V - driver included in base - TRIAC/IGBT or 1-10V, PUSH-DIM dimmable

2 x 4 LED 0.96W - 350mA - 2 x 456lm - 2700K (on demand 6000K) - CRI >93

◆ Choose beam: N=narrow 10° or M=medium 25° or W=wide 40°

LED included - Ceiling -

R54 UP LED



LC ●	MUWW 4222	MUWW 4122	MUWW 4212	MUWW 4112	MUWW 4242	MUWW 4142	995€
LC ●	MUWW 4224	MUWW 4124	MUWW 4214	MUWW 4114	MUWW 4244	MUWW 4144	995€
LC ○	MUWW 4221	MUWW 4121	MUWW 4211	MUWW 4111	MUWW 4241	MUWW 4141	995€
1-10 PU ●	MUWW 4222P	MUWW 4122P	MUWW 4212P	MUWW 4112P	MUWW 4242P	MUWW 4142P	1.045€
1-10 PU ●	MUWW 4224P	MUWW 4124P	MUWW 4214P	MUWW 4114P	MUWW 4244P	MUWW 4144P	1.045€
1-10 PU ○	MUWW 4221P	MUWW 4121P	MUWW 4211P	MUWW 4111P	MUWW 4241P	MUWW 4141P	1.045€



230V - driver included in base - TRIAC/IGBT or 1-10V, PUSH-DIM dimmable

4 x 4 LED 0.96W - 350mA - 4 x 456lm - 2700K (on demand 6000K) - CRI >93



◆ Choose beam: N=narrow 10° or M=medium 25° or W=wide 40°

LED included - Ceiling -



	DIM	RING	FRAME	INTERIOR	FRAME	INTERIOR	FRAME	INTERIOR	FRAME	INTERIOR	FRAME	INTERIOR	FRAME	INTERIOR	RETAIL PRICE	VAT. EXCL.
	NO	●	●	●	●	○	○	○	○	○	○	○	○	○	312€	
	NO	○	●	●	●	○	○	○	○	○	○	○	○	○	372€	
	NO	○	○	●	●	○	○	○	○	○	○	○	○	○	312€	
	NO	○	○	○	○	○	○	○	○	○	○	○	○	○	312€	

230V - transformer included in base - non-dimmable
 BA15d - 1 x QR70 max. 50W, Eco version available on demand
Bulb excluded - Ceiling -  



	LC	●	●	●	●	○	○	○	○	○	○	○	○	○	382€	
	LC	○	●	●	●	○	○	○	○	○	○	○	○	○	530€	
	LC	○	○	●	●	○	○	○	○	○	○	○	○	○	382€	
	LC	○	○	○	○	○	○	○	○	○	○	○	○	○	382€	

230V - transformer included in base - TRIAC/IGBT dimmable
 BA15d - 2 x QR70 max. 50W, Eco version available on demand.
Bulbs excluded - Ceiling -  



	LC	●	●	●	●	○	○	○	○	○	○	○	○	○	323€	
	LC	○	●	●	●	○	○	○	○	○	○	○	○	○	394€	
	LC	○	○	●	●	○	○	○	○	○	○	○	○	○	323€	
	LC	○	○	○	○	○	○	○	○	○	○	○	○	○	323€	

230V - transformer included in base - TRIAC/IGBT dimmable
 G53 - 1 x R111 HALO max. 50W
Bulb excluded - Ceiling -  



	LC	●	●	●	●	○	○	○	○	○	○	○	○	○	323€	
	LC	○	●	●	●	○	○	○	○	○	○	○	○	○	394€	
	LC	○	○	●	●	○	○	○	○	○	○	○	○	○	323€	
	LC	○	○	○	○	○	○	○	○	○	○	○	○	○	323€	

230V - transformer included in base - TRIAC/IGBT dimmable
 G53 - 1 x R111 LED max. 60W
LED bulb excluded - Ceiling -   

	LC	●	●	●	●	○	○	○	○	○	○	○	○	○	406€	
	LC	○	●	●	●	○	○	○	○	○	○	○	○	○	558€	
	LC	○	○	●	●	○	○	○	○	○	○	○	○	○	406€	
	LC	○	○	○	○	○	○	○	○	○	○	○	○	○	406€	

230V - transformer included in base - TRIAC/IGBT dimmable
 G53 - 2 x R111 HALO max. 50W
Bulbs excluded - Ceiling -  

	LC	●	●	●	●	○	○	○	○	○	○	○	○	○	406€	
	LC	○	●	●	●	○	○	○	○	○	○	○	○	○	558€	
	LC	○	○	●	●	○	○	○	○	○	○	○	○	○	406€	
	LC	○	○	○	○	○	○	○	○	○	○	○	○	○	406€	

230V - transformer included in base - TRIAC/IGBT dimmable
 G53 - 2 x R111 LED max. 45W
LED bulbs excluded - Ceiling -   

FLEX LENGTH

SCAR-LED 1FD built-in 45 (no dim)

! driver remote mounting incl. driver does not fit through cutout hole of fixture



	DIM	FRAME	FLEX	FRAME	FLEX	FRAME	FLEX	FRAME	FLEX	RETAIL PRICE VAT. EXCL.
L 200	NO	●	●	○	○	●	●	○	○	220€
L 400	NO	●	●	○	○	●	●	○	○	225€
L 750	NO	●	●	○	○	●	●	○	○	235€

110V-230V - driver included (remote mounting: driver does not fit through cutout hole of fixture) - non-dimmable

1 x LED 0.96W - 350mA - 114lm - 2700K (on demand 6000K) - CRI >93

◆ Choose beam: N=narrow 10° or M=medium 25° or W=wide 40°

LED included - Wall & ceiling -

SCAR-LED 1FD built-in 45 (dim)

! driver remote mounting incl. driver does not fit through cutout hole of fixture



	DIM	FRAME	FLEX	FRAME	FLEX	FRAME	FLEX	FRAME	FLEX	RETAIL PRICE VAT. EXCL.
L 200	1-10 PU	●	●	○	○	●	●	○	○	280€
L 400	1-10 PU	●	●	○	○	●	●	○	○	285€
L 750	1-10 PU	●	●	○	○	●	●	○	○	290€

230V - driver included (remote mounting: driver does not fit through cutout hole of fixture) - 1-10V or PUSH-DIM dimmable

1 x LED 1.38W - 500mA - 157lm - 2700K - CRI >93

◆ Choose beam: N=narrow 10° or M=medium 25° or W=wide 40°

LED included - Wall & ceiling -

SCAR-LED 1FD built-in 60 (no dim)

! driver remote mounting incl.



	DIM	FRAME	FLEX	FRAME	FLEX	FRAME	FLEX	FRAME	FLEX	RETAIL PRICE VAT. EXCL.
L 200	NO	●	●	○	○	●	●	○	○	220€
L 400	NO	●	●	○	○	●	●	○	○	225€
L 750	NO	●	●	○	○	●	●	○	○	235€

110V-230V - driver included (remote mounting: driver fits through cutout hole of fixture) - non-dimmable

1 x LED 0.96W - 350mA - 114lm - 2700K (on demand 6000K) - CRI >93

aperture: 25 x 45 mm - depth for driver behind fixture: min. 55 mm

◆ Choose beam: N=narrow 10° or M=medium 25° or W=wide 40°

LED included - Wall & ceiling -

SCAR-LED 1FD built-in 60 (dim)

! driver remote mounting incl.



	DIM	FRAME	FLEX	FRAME	FLEX	FRAME	FLEX	FRAME	FLEX	RETAIL PRICE VAT. EXCL.
L 200	1-10 PU	●	●	○	○	●	●	○	○	280€
L 400	1-10 PU	●	●	○	○	●	●	○	○	285€
L 750	1-10 PU	●	●	○	○	●	●	○	○	290€

230V - driver included (remote mounting: driver fits through cutout hole of fixture) - 1-10V or PUSH-DIM dimmable

1 x LED 1.38W - 500mA - 157lm - 2700K - CRI >93

aperture: 25 x 55 mm - depth for driver behind fixture: min. 72 mm

◆ Choose beam: N=narrow 10° or M=medium 25° or W=wide 40°

LED included - Wall & ceiling -

SCAR-LED 1FDS built-in 60 (no dim)

! driver remote mounting incl.

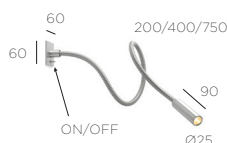

	DIM	FRAME	FLEX	FRAME	FLEX	FRAME	FLEX	FRAME	FLEX	RETAIL PRICE VAT. EXCL.
L 200	NO	●	●	○	○	●	●	○	○	231€
L 400	NO	●	●	○	○	●	●	○	○	236€
L 750	NO	●	●	○	○	●	●	○	○	245€

110V-230V - driver (remote mounting: driver fits through cutout hole of fixture) - ON/OFF on armature

1 x LED 0.96W - 350mA - 114lm - 2700K (on demand 6000K) - CRI >93

aperture: 25 x 45 mm - depth for driver behind fixture: min. 55 mm

◆ Choose beam: N=narrow 10° or M=medium 25° or W=wide 40°

LED included - Wall -

FLEX LENGTH

SCAR-LED 1FDS built-in 60 (dim)

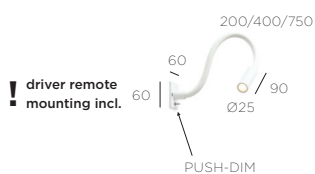

	DIM	FRAME	FLEX	FRAME	FLEX	FRAME	FLEX	FRAME	FLEX	RETAIL PRICE VAT. EXCL.
L 200	▲ PU	●	●	○	○	●	●	●	●	291€
L 400	▲ PU	●	●	○	○	●	●	●	●	296€
L 750	▲ PU	●	●	○	○	●	●	●	●	305€

230V - driver (remote mounting: driver fits through cutout hole of fixture) - PUSH-DIM on armature
 1 x LED 1.38W - 500mA - 157lm - 2700K - CRI >93
 aperture : 25 x 55 mm - depth for driver behind fixture : min. 72 mm
 ♦ Choose beam: N=narrow 10° or M=medium 25° or W=wide 40°
LED included - Wall -

SCAR-LED 1FD built-in 95 (no dim)



L 200	▲ NO	●	●	●	●	●	●	●	●	225€
L 400	▲ NO	●	●	●	●	●	●	●	●	230€
L 750	▲ NO	●	●	●	●	●	●	●	●	240€

110V-230V - driver included (remote mounting) - non-dimmable
 1 x LED 0.96W - 350mA - 114lm - 2700K (on demand 6000K) - CRI >93
 aperture : 25 x 45 mm - depth for driver behind fixture : min. 55 mm
 ♦ Choose beam: N=narrow 10° or M=medium 25° or W=wide 40°
LED included - Wall & ceiling -

SCAR-LED 1FD built-in 95 (dim)

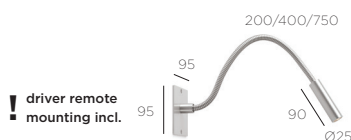

L 200	▲ 1-10 PU	●	●	●	●	●	●	●	●	285€
L 400	▲ 1-10 PU	●	●	●	●	●	●	●	●	290€
L 750	▲ 1-10 PU	●	●	●	●	●	●	●	●	300€

230V - driver included (remote mounting) - 1-10V or PUSH-DIM dimmable
 1 x LED 1.38W - 500mA - 157lm - 2700K - CRI >93
 aperture : 25 x 55 mm - depth for driver behind fixture : min. 72 mm
 ♦ Choose beam: N=narrow 10° or M=medium 25° or W=wide 40°
LED included - Wall & ceiling -

SCAR-LED 1FDS built-in 95 (no dim)

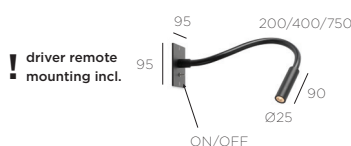

L 200	▲ NO	●	●	●	●	●	●	●	●	236€
L 400	▲ NO	●	●	●	●	●	●	●	●	241€
L 750	▲ NO	●	●	●	●	●	●	●	●	250€

110V-230V - driver (remote mounting: driver fits through cutout hole of fixture) - ON/OFF on armature
 1 x LED 0.96W - 350mA - 114lm - 2700K (on demand 6000K) - CRI >93
 aperture : 25 x 45 mm - depth for driver behind fixture : min. 55 mm
 ♦ Choose beam: N=narrow 10° or M=medium 25° or W=wide 40°
LED included - Wall -

SCAR-LED 1FDS built-in 95 (dim)



L 200	▲ PU	●	●	●	●	●	●	●	●	296€
L 400	▲ PU	●	●	●	●	●	●	●	●	301€
L 750	▲ PU	●	●	●	●	●	●	●	●	310€

230V - driver (remote mounting: driver fits through cutout hole of fixture) - PUSH-DIM on armature
 1 x LED 1.38W - 500mA - 157lm - 2700K - CRI >93
 aperture : 25 x 55 mm - depth for driver behind fixture : min. 72 mm
 ♦ Choose beam: N=narrow 10° or M=medium 25° or W=wide 40°
LED included - Wall -

FLEX LENGTH

SCAR-LED 1FD built-up (no dim)

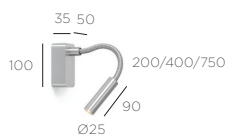

	DIM	FRAME	FLEX	FRAME	FLEX	FRAME	FLEX	FRAME	FLEX	RETAIL PRICE VAT. EXCL.
L 200	NO	●	●	○	○	●	●	○	○	240€
L 400	NO	●	●	○	○	●	●	○	○	245€
L 750	NO	●	●	○	○	●	●	○	○	254€

110V-230V - **driver included in base - non-dimmable**
 1 x LED 0.96W - 350mA - 114lm - 2700K (on demand 6000K) - CRI >93
 ♦ Choose beam: N=narrow 10° or M=medium 25° or W=wide 40°
LED included - Wall & ceiling -

SCAR-LED 1FDS built-up (no dim)

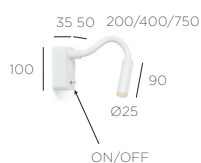

L 200	NO	●	●	○	○	●	●	○	○	250€
L 400	NO	●	●	○	○	●	●	○	○	255€
L 750	NO	●	●	○	○	●	●	○	○	264€

110V-230V - **driver in base - ON/OFF on armature**
 1 x LED 0.96W - 350mA - 114lm - 2700K (on demand 6000K) - CRI >93
 ♦ Choose beam: N=narrow 10° or M=medium 25° or W=wide 40°
LED included - Wall -

SCAR-LED 1FDS built-up plug (no dim)

NEW



L 200	NO	●	●	○	○	●	●	○	○	290€
L 400	NO	●	●	○	○	●	●	○	○	295€
L 750	NO	●	●	○	○	●	●	○	○	304€

110V-230V - **driver included in base - EU-plug - ON/OFF on armature**
 1 x LED 0.96W - 350mA - 114lm - 2700K (on demand 6000K) - CRI >93
 ♦ Choose beam: N=narrow 10° or M=medium 25° or W=wide 40°
LED included - Wall -

SCAR-LITE 1FD built-in (no dim)

! driver remote mounting incl.

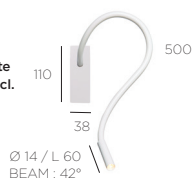

L 500	NO	●	●	○	○	●	●	○	○	225€
-------	----	---	---	---	---	---	---	---	---	------

110V-230V - **driver included (remote mounting) - non-dimmable**
 1 x LED 0.96W - 350mA - 114lm - 2700K - CRI >93
 aperture : 25 x 45 mm - depth for driver behind fixture : min. 55 mm
LED included - Wall & ceiling -

SCAR-LITE 1FD built-in (dim)

! driver remote mounting incl.



L 500	1-10	●	●	○	○	●	●	○	○	285€
-------	------	---	---	---	---	---	---	---	---	------

230V - **driver included (remote mounting) - 1-10V or PUSH-DIM dimmable**
 1 x LED 1.38W - 500mA - 157lm - 2700K - CRI >93
 aperture : 25 x 55 mm - depth for driver behind fixture : min. 72 mm
LED included - Wall & ceiling -

SCAR-LITE 1FDS built-in (no dim)

! driver remote mounting incl.



L 500	NO	●	●	○	○	●	●	○	○	236€
-------	----	---	---	---	---	---	---	---	---	------

110V-230V - **driver (remote mounting) - ON/OFF on armature**
 1 x LED 0.96W - 350mA - 114lm - 2700K - CRI >93
 aperture : 25 x 45 mm - depth for driver behind fixture : min. 55 mm
LED included - Wall -

FLEX LENGTH

DIM

FRAME

FLEX

FRAME



FLEX

RETAIL PRICE
VAT. EXCL.

SCAR-LITE 1FDS built-in (dim)

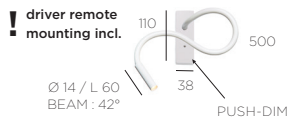
L 500  I SCLI 7591P SCLI 7561P I 296€





230V - **driver (remote mounting) - PUSH-DIM on armature**
 1 x LED 1.38W - 500mA - 157lm - 2700K - CRI >93
 aperture : 25 x 55 mm - depth for driver behind fixture : min. 72 mm
LED included - Wall -   

SCAR-LITE 1FDS built-up (no dim)

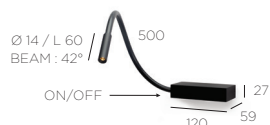
L 500  I SCLI 3502 SCLI 3501 I 305€





110V-230V - **driver in base - ON/OFF on armature**
 1 x LED 0.96W - 350mA - 114lm - 2700K - CRI >93
LED included - Wall -   

SCAR-LITE 1FDS built-up (dim)

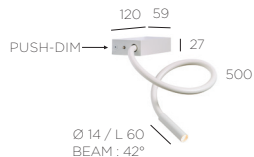
L 500  I SCLI 5002 SCLI 5001 I 365€





230V - **driver in base - PUSH-DIM on armature**
 1 x LED 1.38W - 500mA - 157lm - 2700K - CRI >93
LED included - Wall -   

SCAR-LITE 1FDS built-up plug (no dim)

L 500  I SCLI 3502EU SCLI 3501EU I 345€





110V-230V - **driver in base - EU-plug - ON/OFF on armature**
 1 x LED 0.96W - 350mA - 114lm - 2700K - CRI >93
LED included - Wall -   

SCAR-LITE 1FDS built-up plug (dim)

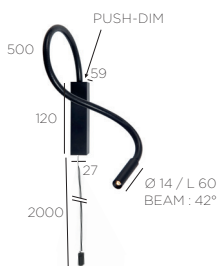
L 500  I SCLI 5002EU SCLI 5001EU I 405€





230V - **driver in base - EU-plug - PUSH-DIM on armature**
 1 x LED 1.38W - 500mA - 157lm - 2700K - CRI >93
LED included - Wall -   

SCAR-LITE 1FDS USB built-up (dim)

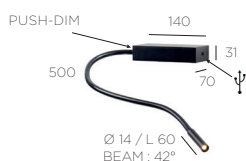
L 500  I SCLIU 5002 SCLIU 5001 I 430€



110V-230V - **driver in base - PUSH-DIM on armature**
 USB charger 5A incl. - compatible with iPad/iPhone and other USB chargeable devices
 1 x LED 1.38W - 500mA - 157lm - 2700K - CRI >93
LED included - Wall -   

FRAME



FRAME



FRAME



RETAIL PRICE
VAT. EXCL.

SIRENS W/C diffuser glass

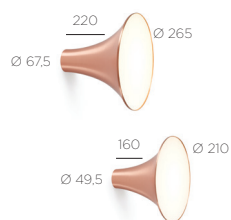

Ø 210	SIPR 2112	SIPR 2111	309€
Ø 265	SIPR 2612	SIPR 2611	371€
Ø 210		SIPR 2117	325€
Ø 265		SIPR 2617	387€

110V-230V

E27 - only energy saving bulbs (LED or FLUO)

LED or FLUO bulb excluded - Wall & ceiling -

SIRENS W/C mirror

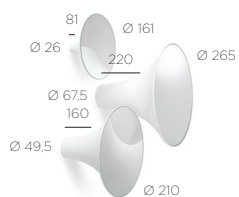

Ø 161	SIPR 1602	SIPR 1601	149€
Ø 210	SIPR 2102	SIPR 2101	232€
Ø 265	SIPR 2602	SIPR 2601	278€
Ø 161		SIPR 1607	165€
Ø 210		SIPR 2107	247€
Ø 265		SIPR 2607	294€

Wall & ceiling

SIRENS W/C frosted glass big mirror + edge mirror



Ø 210	SIPR 2122	SIPR 2121	289€
Ø 265	SIPR 2622	SIPR 2621	335€
Ø 210		SIPR 2127	304€
Ø 265		SIPR 2627	350€

110V-230V

E27 - only energy saving bulbs (LED or FLUO)

LED or FLUO bulb excluded - Wall & ceiling -

SIRENS W/C frosted glass small mirror + edge mirror

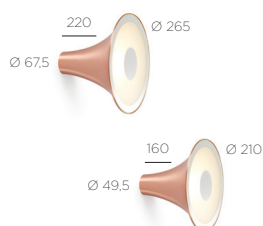

Ø 210	SIPR 2132	SIPR 2131	289€
Ø 265	SIPR 2632	SIPR 2631	335€
Ø 210		SIPR 2137	304€
Ø 265		SIPR 2637	350€

110V-230V

E27 - only energy saving bulbs (LED or FLUO)

LED or FLUO bulb excluded - Wall & ceiling -

SIRENS W/C frosted glass edge mirror

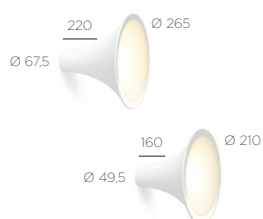

Ø 210	SIPR 2142	SIPR 2141	289€
Ø 265	SIPR 2642	SIPR 2641	335€
Ø 210		SIPR 2147	304€
Ø 265		SIPR 2647	350€

110V-230V

E27 - only energy saving bulbs (LED or FLUO)

LED or FLUO bulb excluded - Wall & ceiling -

Suspension

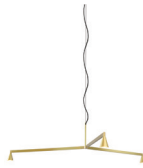

AUSTERE-CHANDELIER 1Y

DESIGN YOUR OWN CHANDELIER	46
CHANDELIER 1Y RF 75 remote	48
CHANDELIER 1Y RF 100 remote	48
CHANDELIER 1Y RS 16 remote	49
CHANDELIER 1Y RL 79 remote	49
CHANDELIER 1Y RS 16 surface	50
CHANDELIER 1Y RL 79 surface	50

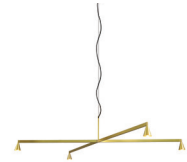

AUSTERE-CHANDELIER 1X

DESIGN YOUR OWN CHANDELIER	46
CHANDELIER 1X RF 75 remote	57
CHANDELIER 1X RF 100 remote	57
CHANDELIER 1X RS 16 remote	58
CHANDELIER 1X RL 79 remote	58
CHANDELIER 1X RS 16 surface	59
CHANDELIER 1X RL 79 surface	59



AUSTERE-CHANDELIER 2Y

DESIGN YOUR OWN CHANDELIER	46
CHANDELIER 2Y RF 75 remote	51
CHANDELIER 2Y RF 100 remote	51
CHANDELIER 2Y RS 16 remote	52
CHANDELIER 2Y RL 79 remote	52
CHANDELIER 2Y RS 16 surface	53
CHANDELIER 2Y RL 79 surface	53



AUSTERE-CHANDELIER 2X

DESIGN YOUR OWN CHANDELIER	46
CHANDELIER 2X RF 75 remote	60
CHANDELIER 2X RF 100 remote	60
CHANDELIER 2X RS 16 remote	61
CHANDELIER 2X RL 79 remote	61
CHANDELIER 2X RS 16 surface	62
CHANDELIER 2X RL 79 surface	62



AUSTERE-CHANDELIER 3Y

DESIGN YOUR OWN CHANDELIER	46
CHANDELIER 3Y RF 75 remote	54
CHANDELIER 3Y RF 100 remote	54
CHANDELIER 3Y RS 16 remote	55
CHANDELIER 3Y RL 79 remote	55
CHANDELIER 3Y RS 16 surface	56
CHANDELIER 3Y RL 79 surface	56

Suspension



AUSTERE-CHANDELIER 3X

DESIGN YOUR OWN CHANDELIER	46
CHANDELIER 3X RF 75 remote	63
CHANDELIER 3X RF 100 remote	63
CHANDELIER 3X RS 16 remote	64
CHANDELIER 3X RL 79 remote	64
CHANDELIER 3X RS 16 surface	65
CHANDELIER 3X RL 79 surface	65



AUSTERE-SOLITAIRE

AUSTERE-SOLITAIRE RF	73
AUSTERE-SOLITAIRE RF D+B	73
AUSTERE-SOLITAIRE RL	74
AUSTERE-SOLITAIRE RL D+B	74



LIPPS SU

LIPPS 200 SU	80
LIPPS 300 SU	81
LIPPS 600 SU	81



AUSTERE-SUSPENSION 1+

DESIGN YOUR OWN SUSPENSION	75
SUSPENSION 1+ RF 75 remote	77
SUSPENSION 1+ RF 100 remote	77
SUSPENSION 1+ RS 16 remote	78
SUSPENSION 1+ RL 79 remote	78
SUSPENSION 1+ RS 16 surface	79
SUSPENSION 1+ RL 79 surface	79



N-TRO

N-TRO	81
N-TRO D+B	81

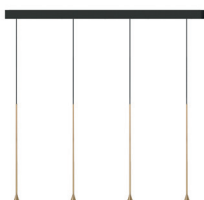

AUSTERE D

AUSTERE D1 2 RF 75	66
AUSTERE D1 3 RF 75	66
AUSTERE D1 4 RF 75	66
AUSTERE D1 2 RF 100	67
AUSTERE D1 3 RF 100	67
AUSTERE D1 4 RF 100	67
AUSTERE D2 4 RF 75	68
AUSTERE D2 5 RF 75	68
AUSTERE D2 6 RF 75	68
AUSTERE D2 4 RF 100	69
AUSTERE D2 5 RF 100	69
AUSTERE D2 6 RF 100	69
AUSTERE D1 2 RL	70
AUSTERE D1 3 RL	70
AUSTERE D1 4 RL	71
AUSTERE D2 4 RL	71
AUSTERE D2 5 RL	72
AUSTERE D2 6 RL	72



I-TRO

I-TRO	80
I-TRO D+B	80



SIRENS SU

SIRENS SU diffuser glass	82
SIRENS SU mirror	82
SIRENS SU frosted glass	
big mirror + edge mirror	82
SIRENS SU frosted glass	
small mirror + edge mirror	82
SIRENS SU frosted glass edge mirror	82

DESIGN YOUR OWN AUSTERE-CHANDELIER - REMOTE MOUNTING

I. Choose the shape of the chandelier: Y or X

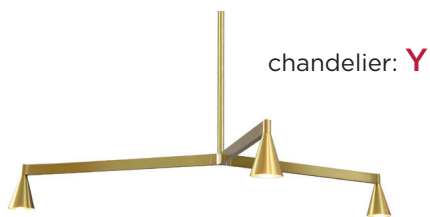

II. Choose the levels of the chandelier: 1 level, 2 levels or 3 levels



III. Choose the arm length per level: 250 mm, 500 mm or 750 mm (Each arm on the same level has the same length)

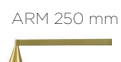

Y chandelier: 3 x 250 mm = Ø 590 mm

X chandelier: 4 x 250 mm = L: 516 mm W: 316 mm



Y chandelier: 3 x 500 mm = Ø 1090 mm

X chandelier: 4 x 500 mm = L: 949 mm W: 565 mm



Y chandelier: 3 x 750 mm = Ø 1590 mm

X chandelier: 4 x 750 mm = L: 1382 mm W: 815 mm

IV. Choose the colors and the vertical ROD: RS 16, RL 79, RF 75 or RF 100

rod: **RS 16**

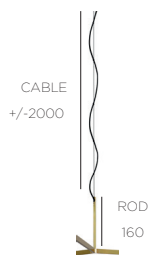

- FRAME
- POWERCORD

rod: **RL 79**

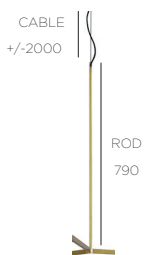

- FRAME
- POWERCORD

rod: **RF 75**

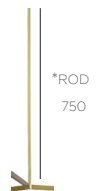

- FRAME

*Total height depends on the chosen mounting option, SEE **! NOTE** on product page.

Shorter rod available on demand with additional cost.

rod: **RF 100**



- FRAME

*Total height depends on the chosen mounting option, SEE **! NOTE** on product page.

Shorter rod available on demand with additional cost.

V. Choose your cover or canopy for 'remote mounting' driver:

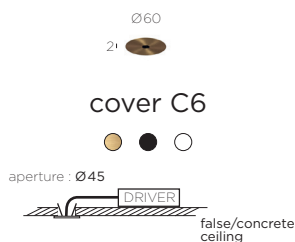

cover C6

-
-
-

For false ceiling: RS 16, RL 79, RF 75 & RF 100
For concrete ceiling: RS 16 & RL 79

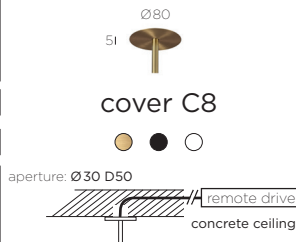

cover C8

-
-
-

For RF 75 & RF 100

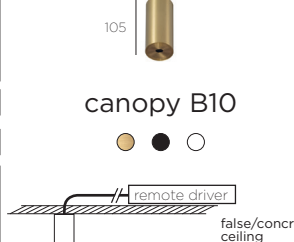

canopy B10

-
-
-

For RS 16, RL 79, RF 75 & RF 100

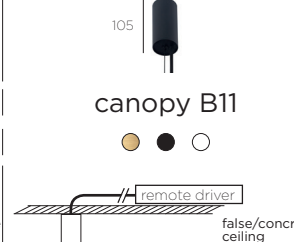

canopy B11

-
-
-

For RS 16 & RL 79

VI. Choose your 'remote mounting' driver:

driver: non-dimmable

driver: 1-10V dimmable
driver: PUSH-DIM dimmable
driver: DALI dimmable

DESIGN YOUR OWN AUSTERE-CHANDELIER - SURFACE MOUNTING

I. Choose the shape of the chandelier: Y or X

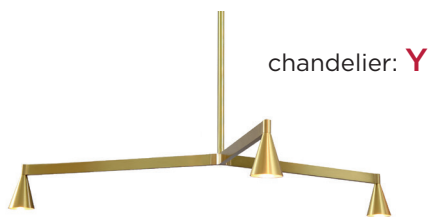

II. Choose the levels of the chandelier: 1 level, 2 levels or 3 levels



III. Choose the arm length per level: 250 mm, 500 mm or 750 mm (Each arm on the same level has the same length)

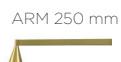

Y chandelier: 3 x 250 mm = Ø 590 mm

X chandelier: 4 x 250 mm = L: 516 mm W: 316 mm



Y chandelier: 3 x 500 mm = Ø 1090 mm

X chandelier: 4 x 500 mm = L: 949 mm W: 565 mm

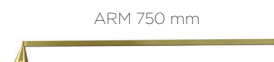

Y chandelier: 3 x 750 mm = Ø 1590 mm

X chandelier: 4 x 750 mm = L: 1382 mm W: 815 mm

IV. Choose the colors and the vertical ROD: RS 16 or RL 79

rod: **RS 16**

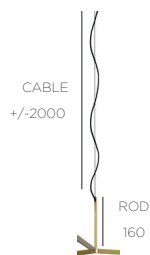

- FRAME
- POWERCORD

rod: **RL 79**

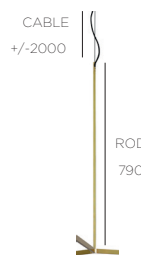

- FRAME
- POWERCORD

V. Choose your base (driver incl.) for 'surface mounting':



base B20

-

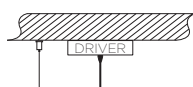

dimmable driver incl. in base
(1-10V / PUSH-DIM / DALI)
+ casambi possible
Only for 1Y, 2Y, 1X
Max. 6 light-elements



base B21

-

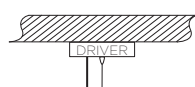

dimmable driver incl. in base
(1-10V / PUSH-DIM / DALI)
+ casambi possible
Only for 1Y, 2Y, 1X
Max. 6 light-elements

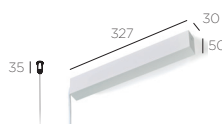

base B32

-

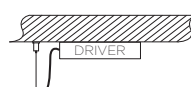

non-dimmable driver incl. in base

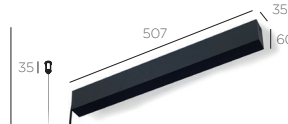

base B50

-



dimmable driver incl. in base
(1-10V / PUSH-DIM / DALI)
+ casambi possible

LENGTH / LEVEL

FRAME

FRAME

RETAIL PRICE
 VAT. EXCL.

REMOTE MOUNTING

AUSTERE-CHANDELIER 1Y RF 75 NEW

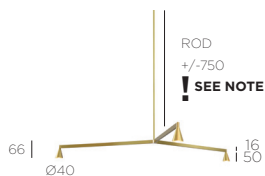

3x 250mm
 3x 500mm
 3x 750mm

1Y RF7 2023	1Y RF7 2022	1.171€
1Y RF7 5023	1Y RF7 5022	1.201€
1Y RF7 7023	1Y RF7 7022	1.234€

AUSTERE-CHANDELIER 1Y RF 100

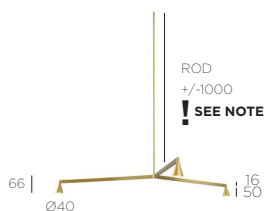

3x 250mm
 3x 500mm
 3x 750mm

1Y RF10 2023	1Y RF10 2022	1.181€
1Y RF10 5023	1Y RF10 5022	1.211€
1Y RF10 7023	1Y RF10 7022	1.244€

Shorter RF ROD available in other lengths on demand & with additional cost.

350mA - driver + cover/canopy required* see below

3 x LED array 6,2W - 350mA - 3 x 630lm - 2700K - CRI >98 - dimmable

Each arm on the same level has the same length: 3 x 250 mm = Ø 590 mm / 3 x 500 mm = Ø 1090 mm / 3 x 750 mm = Ø 1590 mm.

LED included - Suspension -

*REQUIRED FOR REMOTE MOUNTING: COVER/CANOPY

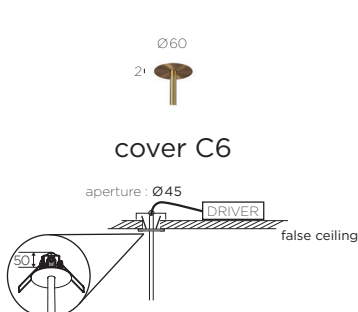

cover C6

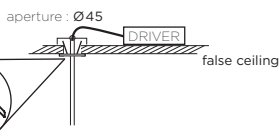

	21CO 3300	68€
	21CO 2200	68€
	21CO 1100	68€

! NOTE: cover C6 + rod RF 75 :
 If the thickness of the false ceiling is 15mm, the total length of the chandelier RF 75 with cover C6 will be 778mm.

! NOTE: cover C6 + rod RF 100 :
 If the thickness of the false ceiling is 15mm, the total length of the chandelier RF 100 with cover C6 will be 1028mm.

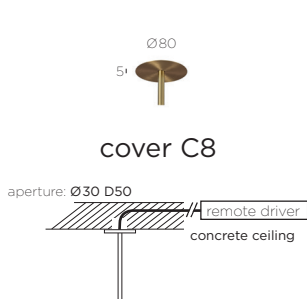

cover C8

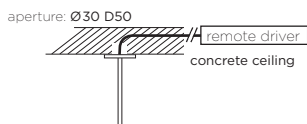

21CO 8003	80€
21CO 8002	80€
21CO 8001	80€

! NOTE: cover C8 + rod RF 75 :
 the total length of the chandelier RF 75 with cover C8 will be 806mm.

! NOTE: cover C8 + rod RF 100 :
 the total length of the chandelier RF 100 with cover C8 will be 1056mm.

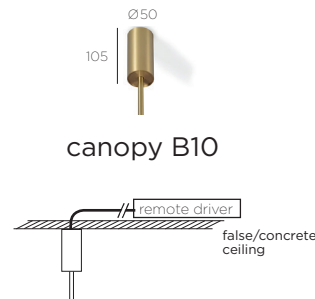

canopy B10

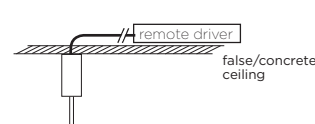

21CP 3333	222€
21CP 2222	222€
21CP 1111	222€

! NOTE: canopy B10 + rod RF 75 :
 the total length of the chandelier RF 75 with canopy B10 will be 906mm.

! NOTE: canopy B10 + rod RF 100 :
 the total length of the chandelier RF 100 with canopy B10 will be 1156mm.

*REQUIRED FOR REMOTE MOUNTING: DRIVER

DEVICE	DIM.	DRIVER	NET PRICE	DEVICE	DIM.	DRIVER	NET PRICE
1 x	NO	N 50W *	24€	1 x	1-10 PU	D 80WP *	37€
					DA PU	D 80WD *	42€

* driver only fits through cutout hole of fixture with C6. min. depth for driver in false ceiling: 280mm

For warranty use only Trizo21® supplied LED drivers as mentioned. For all specs and techs about drivers, see www.trizo21.com/drivers

LENGTH / LEVEL	FRAME	POWERCORD	STEELCABLE	FRAME	POWERCORD	STEELCABLE	FRAME	POWERCORD	STEELCABLE	FRAME	POWERCORD	STEELCABLE	RETAIL PRICE VAT. EXCL.
	●	●	●	●	●	●	●	○	○	●	○	○	

REMOTE MOUNTING

AUSTERE-CHANDELIER 1Y RS 16

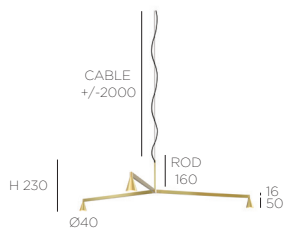

3x 250mm	1Y RS 2023	1Y RS 2022	1Y RS 2013	1Y RS 2012	1.151€
3x 500mm	1Y RS 5023	1Y RS 5022	1Y RS 5013	1Y RS 5012	1.181€
3x 750mm	1Y RS 7023	1Y RS 7022	1Y RS 7013	1Y RS 7012	1.214€

AUSTERE-CHANDELIER 1Y RL 79

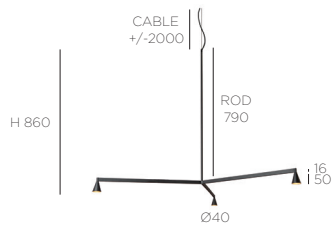

3x 250mm	1Y RL 2023	1Y RL 2022	1Y RL 2013	1Y RL 2012	1.181€
3x 500mm	1Y RL 5023	1Y RL 5022	1Y RL 5013	1Y RL 5012	1.211€
3x 750mm	1Y RL 7023	1Y RL 7022	1Y RL 7013	1Y RL 7012	1.244€

350mA - driver + cover/canopy required* see below
 3 x LED array 6,2W - 350mA - 3 x 630lm - 2700K - CRI >98 - dimmable
 Each arm on the same level has the same length: 3 x 250 mm = Ø 590 mm / 3 x 500 mm = Ø 1090 mm / 3 x 750 mm = Ø 1590 mm.
 LED included - Suspension -

*REQUIRED FOR REMOTE MOUNTING: COVER/CANOPY

cover C6	cover C6	canopy B10	canopy B11
aperture : Ø45 false ceiling	aperture : Ø45 concrete ceiling	false/concrete ceiling	false/concrete ceiling
● 21CO 0003 68€	● 21CO 0013 84€	● 21CP 3003 222€	● 21CP 3033 222€
● 21CO 0002 68€	● 21CO 0012 84€	● 21CP 2002 222€	● 21CP 2022 222€
○ 21CO 0001 68€	○ 21CO 0011 84€	○ 21CP 1001 222€	○ 21CP 1011 222€

*REQUIRED FOR REMOTE MOUNTING: DRIVER

DEVICE	DIM.	DRIVER	NET PRICE	DEVICE	DIM.	DRIVER	NET PRICE
1 x	NO	N 50W*	24€	1 x	I-HO DA	D 80WP* D 80WD*	37€ 42€

* driver only fits through cutout hole of fixture with C6.
 min. depth for driver in false ceiling: 280mm

For warranty use only Trizo21® supplied LED drivers as mentioned.
 For all specs and techs about drivers, see www.trizo21.com/drivers

LENGTH / LEVEL	FRAME	POWERCORD	STEELCABLE	FRAME	POWERCORD	STEELCABLE	FRAME	POWERCORD	STEELCABLE	FRAME	POWERCORD	STEELCABLE
	●	●	●	●	●	●	●	○	○	●	○	○

RETAIL PRICE
 VAT. EXCL.

SURFACE MOUNTING

AUSTERE-CHANDELIER 1Y RS 16

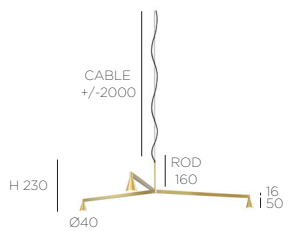

3x 250mm	1Y RS 2023	1Y RS 2022	1Y RS 2013	1Y RS 2012	1.151€
3x 500mm	1Y RS 5023	1Y RS 5022	1Y RS 5013	1Y RS 5012	1.181€
3x 750mm	1Y RS 7023	1Y RS 7022	1Y RS 7013	1Y RS 7012	1.214€

AUSTERE-CHANDELIER 1Y RL 79

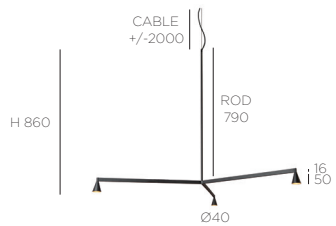

3x 250mm	1Y RL 2023	1Y RL 2022	1Y RL 2013	1Y RL 2012	1.181€
3x 500mm	1Y RL 5023	1Y RL 5022	1Y RL 5013	1Y RL 5012	1.211€
3x 750mm	1Y RL 7023	1Y RL 7022	1Y RL 7013	1Y RL 7012	1.244€

350mA - **driver + base required*** see below
 3 x LED array 6,2W - 350mA - 3 x 630lm - 2700K - CRI >98 - **dimmable**
 Each arm on the same level has the same length: 3 x 250 mm = Ø 590 mm / 3 x 500 mm = Ø 1090 mm / 3 x 750 mm = Ø 1590 mm.
LED included - Suspension -

*REQUIRED FOR SURFACE MOUNTING: BASE (DRIVER INCL.)



base B20

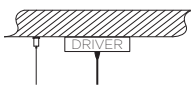

base B21

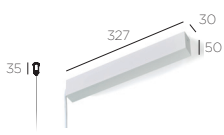
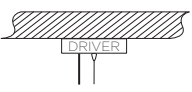

base B32

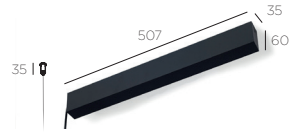
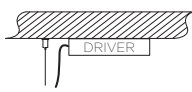

base B50

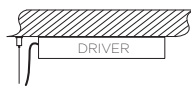

●	1H0 PU	BCPU 2402	255€	1H0 PU	BCPU 2422	255€	NO	BNDN 0822	365€	1H0 PU	BDPU 0822	445€
○	1H0 PU	BCPU 2401	255€	1H0 PU	BCPU 2411	255€	NO	BNDN 0811	365€	1H0 PU	BDPU 0811	445€
●	DA PU	BCDA 2402	255€	DA PU	BCDA 2422	255€				DA PU	BDDA 0822	470€
○	DA PU	BCDA 2401	255€	DA PU	BCDA 2411	255€				DA PU	BDDA 0811	470€

110V-230V - **driver included in base**
 + casambi possible

110V-230V - **driver included in base**
 + casambi possible

230V - **driver included in base**

230V - **driver included in base**
 + casambi possible

LENGTH
/ LEVEL

LENGTH
/ LEVEL

FRAME

FRAME

RETAIL PRICE
VAT. EXCL.

REMOTE MOUNTING

AUSTERE-CHANDELIER 2Y RF 75 NEW

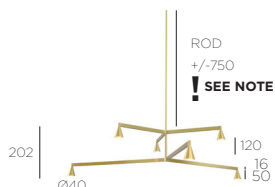

3x 250mm	&	3x 250mm
3x 250mm	&	3x 500mm
3x 500mm	&	3x 500mm
3x 500mm	&	3x 750mm
3x 750mm	&	3x 750mm

2Y RF7 2223	2Y RF7 2222	2.237€
2Y RF7 2523	2Y RF7 2522	2.267€
2Y RF7 5523	2Y RF7 5522	2.297€
2Y RF7 5723	2Y RF7 5722	2.330€
2Y RF7 7723	2Y RF7 7722	2.363€

AUSTERE-CHANDELIER 2Y RF 100

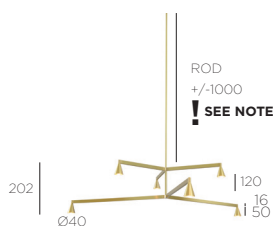

3x 250mm	&	3x 250mm
3x 250mm	&	3x 500mm
3x 500mm	&	3x 500mm
3x 500mm	&	3x 750mm
3x 750mm	&	3x 750mm

2Y RF10 2223	2Y RF10 2222	2.247€
2Y RF10 2523	2Y RF10 2522	2.277€
2Y RF10 5523	2Y RF10 5522	2.307€
2Y RF10 5723	2Y RF10 5722	2.340€
2Y RF10 7723	2Y RF10 7722	2.373€

Shorter RF ROD available in other lengths on demand & with additional cost.

350mA - driver + cover/canopy required* see below

6 x LED array 6,2W - 350mA - 6 x 630lm - 2700K - CRI >98 - dimmable

Each arm on the same level has the same length: 3 x 250 mm = Ø 590 mm / 3 x 500 mm = Ø 1090 mm / 3 x 750 mm = Ø 1590 mm.

LED included - Suspension -

*REQUIRED FOR REMOTE MOUNTING: COVER/CANOPY



cover C6

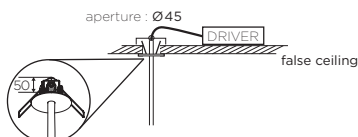

21CO 3300	68€
21CO 2200	68€
21CO 1100	68€

! NOTE: cover C6 + rod RF 75 :

If the thickness of the false ceiling is 15mm, the total length of the chandelier RF 75 with cover C6 will be 914mm.

! NOTE: cover C6 + rod RF 100 :

If the thickness of the false ceiling is 15mm, the total length of the chandelier RF 100 with cover C6 will be 1164mm.



cover C8

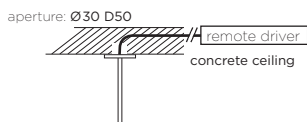

21CO 8003	80€
21CO 8002	80€
21CO 8001	80€

! NOTE: cover C8 + rod RF 75 :

the total length of the chandelier RF 75 with cover C8 will be 942mm.

! NOTE: cover C8 + rod RF 100 :

the total length of the chandelier RF 100 with cover C8 will be 1192mm.



canopy B10

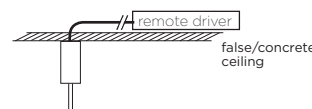

21CP 3333	222€
21CP 2222	222€
21CP 1111	222€

! NOTE: canopy B10 + rod RF 75 :

the total length of the chandelier RF 75 with canopy B10 will be 1042mm.

! NOTE: canopy B10 + rod RF 100 :

the total length of the chandelier RF 100 with canopy B10 will be 1292mm.

*REQUIRED FOR REMOTE MOUNTING: DRIVER

DEVICE	DIM.	DRIVER	NET PRICE	DEVICE	DIM.	DRIVER	NET PRICE
1 x	NO	N 80W*	27€	1 x	I-10 DA	PU DA	37€ 42€

*driver only fits through cutout hole of fixture with C6.
min. depth for driver in false ceiling: 280mm

**For warranty use only Trizo21® supplied LED drivers as mentioned.
For all specs and techs about drivers, see www.trizo21.com/drivers**

LENGTH / LEVEL

LENGTH / LEVEL

FRAME
POWERCORD
STEELCABLE

FRAME
POWERCORD
STEELCABLE

FRAME
POWERCORD
STEELCABLE

FRAME
POWERCORD
STEELCABLE

RETAIL PRICE
VAT. EXCL.



REMOTE MOUNTING

AUSTERE-CHANDELIER 2Y RS 16

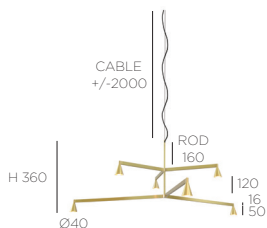

3x 250mm	&	3x 250mm	2Y RS 2223	2Y RS 2222	2Y RS 2213	2Y RS 2212	2.217€
3x 250mm	&	3x 500mm	2Y RS 2523	2Y RS 2522	2Y RS 2513	2Y RS 2512	2.247€
3x 500mm	&	3x 500mm	2Y RS 5523	2Y RS 5522	2Y RS 5513	2Y RS 5512	2.277€
3x 500mm	&	3x 750mm	2Y RS 5723	2Y RS 5722	2Y RS 5713	2Y RS 5712	2.310€
3x 750mm	&	3x 750mm	2Y RS 7723	2Y RS 7722	2Y RS 7713	2Y RS 7712	2.343€

AUSTERE-CHANDELIER 2Y RL 79

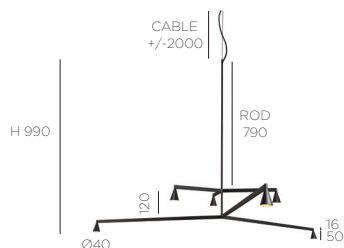

3x 250mm	&	3x 250mm	2Y RL 2223	2Y RL 2222	2Y RL 2213	2Y RL 2212	2.247€
3x 250mm	&	3x 500mm	2Y RL 2523	2Y RL 2522	2Y RL 2513	2Y RL 2512	2.277€
3x 500mm	&	3x 500mm	2Y RL 5523	2Y RL 5522	2Y RL 5513	2Y RL 5512	2.307€
3x 500mm	&	3x 750mm	2Y RL 5723	2Y RL 5722	2Y RL 5713	2Y RL 5712	2.340€
3x 750mm	&	3x 750mm	2Y RL 7723	2Y RL 7722	2Y RL 7713	2Y RL 7712	2.373€

350mA - driver + cover/canopy required* see below

6 x LED array 6,2W - 350mA - 6 x 630lm - 2700K - CRI >98 - dimmable

Each arm on the same level has the same length: 3 x 250 mm = Ø 590 mm / 3 x 500 mm = Ø 1090 mm / 3 x 750 mm = Ø 1590 mm.

LED included - Suspension -

*REQUIRED FOR REMOTE MOUNTING: COVER/CANOPY

cover C6	cover C6	canopy B10	canopy B11																								
aperture: Ø45 false ceiling	aperture: Ø45 concrete ceiling	false/concrete ceiling	false/concrete ceiling																								
<table border="1"> <tr><td>21CO 0003</td><td>68€</td></tr> <tr><td>21CO 0002</td><td>68€</td></tr> <tr><td>21CO 0001</td><td>68€</td></tr> </table>	21CO 0003	68€	21CO 0002	68€	21CO 0001	68€	<table border="1"> <tr><td>21CO 0013</td><td>84€</td></tr> <tr><td>21CO 0012</td><td>84€</td></tr> <tr><td>21CO 0011</td><td>84€</td></tr> </table>	21CO 0013	84€	21CO 0012	84€	21CO 0011	84€	<table border="1"> <tr><td>21CP 3003</td><td>222€</td></tr> <tr><td>21CP 2002</td><td>222€</td></tr> <tr><td>21CP 1001</td><td>222€</td></tr> </table>	21CP 3003	222€	21CP 2002	222€	21CP 1001	222€	<table border="1"> <tr><td>21CP 3033</td><td>222€</td></tr> <tr><td>21CP 2022</td><td>222€</td></tr> <tr><td>21CP 1011</td><td>222€</td></tr> </table>	21CP 3033	222€	21CP 2022	222€	21CP 1011	222€
21CO 0003	68€																										
21CO 0002	68€																										
21CO 0001	68€																										
21CO 0013	84€																										
21CO 0012	84€																										
21CO 0011	84€																										
21CP 3003	222€																										
21CP 2002	222€																										
21CP 1001	222€																										
21CP 3033	222€																										
21CP 2022	222€																										
21CP 1011	222€																										

*REQUIRED FOR REMOTE MOUNTING: DRIVER

DEVICE	DIM.	DRIVER	NET PRICE	DEVICE	DIM.	DRIVER	NET PRICE
1 x	NO	N 80W*	27€	1 x	1-10 PU DA PU	D 80WP* D 80WD*	37€ 42€

* driver only fits through cutout hole of fixture with C6.
min. depth for driver in false ceiling: 280mm

For warranty use only Trizo21® supplied LED drivers as mentioned.
For all specs and techs about drivers, see www.trizo21.com/drivers

LENGTH / LEVEL

LENGTH / LEVEL

FRAME
POWERCORD
STEELCABLE

FRAME
POWERCORD
STEELCABLE

FRAME
POWERCORD
STEELCABLE

FRAME
POWERCORD
STEELCABLE

RETAIL PRICE
VAT. EXCL.



SURFACE MOUNTING

AUSTERE-CHANDELIER 2Y RS 16

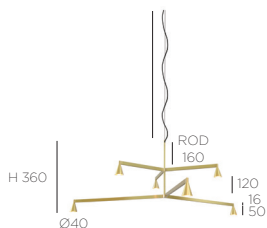

3x 250mm & 3x 250mm	2Y RS 2223	2Y RS 2222	2Y RS 2213	2Y RS 2212	2.217€
3x 250mm & 3x 500mm	2Y RS 2523	2Y RS 2522	2Y RS 2513	2Y RS 2512	2.247€
3x 500mm & 3x 500mm	2Y RS 5523	2Y RS 5522	2Y RS 5513	2Y RS 5512	2.277€
3x 500mm & 3x 750mm	2Y RS 5723	2Y RS 5722	2Y RS 5713	2Y RS 5712	2.310€
3x 750mm & 3x 750mm	2Y RS 7723	2Y RS 7722	2Y RS 7713	2Y RS 7712	2.343€

AUSTERE-CHANDELIER 2Y RL 79

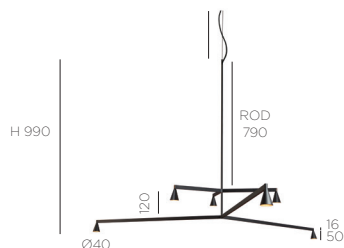

3x 250mm & 3x 250mm	2Y RL 2223	2Y RL 2222	2Y RL 2213	2Y RL 2212	2.247€
3x 250mm & 3x 500mm	2Y RL 2523	2Y RL 2522	2Y RL 2513	2Y RL 2512	2.277€
3x 500mm & 3x 500mm	2Y RL 5523	2Y RL 5522	2Y RL 5513	2Y RL 5512	2.307€
3x 500mm & 3x 750mm	2Y RL 5723	2Y RL 5722	2Y RL 5713	2Y RL 5712	2.340€
3x 750mm & 3x 750mm	2Y RL 7723	2Y RL 7722	2Y RL 7713	2Y RL 7712	2.373€

350mA - driver + base required* see below

6 x LED array 6,2W - 350mA - 6 x 630lm - 2700K - CRI >98 - dimmable

Each arm on the same level has the same length: 3 x 250 mm = Ø 590 mm / 3 x 500 mm = Ø 1090 mm / 3 x 750 mm = Ø 1590 mm.

LED included - Suspension -

*REQUIRED FOR SURFACE MOUNTING: BASE (DRIVER INCL.)



base B20

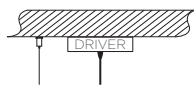

base B21

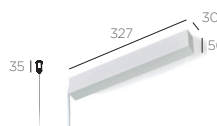
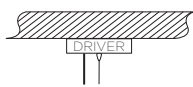

base B32

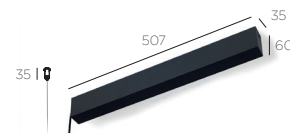
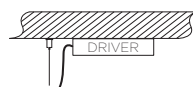

base B50



●	1H0 PU	BCPU 2402	255€	1H0 PU	BCPU 2422	255€	NO	BNDN 0822	365€	1H0 PU	BDPU 0822	445€
○	1H0 PU	BCPU 2401	255€	1H0 PU	BCPU 2411	255€	NO	BNDN 0811	365€	1H0 PU	BDPU 0811	445€
●	DA PU	BCDA 2402	255€	DA PU	BCDA 2422	255€				DA PU	BDDA 0822	470€
○	DA PU	BCDA 2401	255€	DA PU	BCDA 2411	255€				DA PU	BDDA 0811	470€

110V-230V - driver included in base
+ casambi possible

110V-230V - driver included in base
+ casambi possible

230V - driver included in base

230V - driver included in base
+ casambi possible

LENGTH / LEVEL

LENGTH / LEVEL

LENGTH / LEVEL

FRAME

FRAME

RETAIL PRICE
VAT. EXCL.

REMOTE MOUNTING

AUSTERE-CHANDELIER 3Y RF 75 new

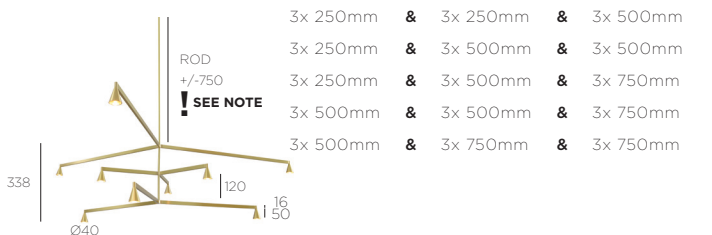

3x 250mm	&	3x 250mm	&	3x 500mm
3x 250mm	&	3x 500mm	&	3x 500mm
3x 250mm	&	3x 500mm	&	3x 750mm
3x 500mm	&	3x 500mm	&	3x 750mm
3x 500mm	&	3x 750mm	&	3x 750mm

3Y RF7 22523	3Y RF7 22522	3.333€
3Y RF7 25523	3Y RF7 25522	3.363€
3Y RF7 25723	3Y RF7 25722	3.396€
3Y RF7 55723	3Y RF7 55722	3.426€
3Y RF7 57723	3Y RF7 57722	3.459€

AUSTERE-CHANDELIER 3Y RF 100



3x 250mm	&	3x 250mm	&	3x 500mm
3x 250mm	&	3x 500mm	&	3x 500mm
3x 250mm	&	3x 500mm	&	3x 750mm
3x 500mm	&	3x 500mm	&	3x 750mm
3x 500mm	&	3x 750mm	&	3x 750mm

3Y RF10 22523	3Y RF10 22522	3.343€
3Y RF10 25523	3Y RF10 25522	3.373€
3Y RF10 25723	3Y RF10 25722	3.406€
3Y RF10 55723	3Y RF10 55722	3.436€
3Y RF10 57723	3Y RF10 57722	3.469€

Shorter RF ROD available in other lengths on demand & with additional cost.

350mA - driver + cover/canopy required* see below

9 x LED array 6,2W - 350mA - 9 x 630lm - 2700K - CRI >98 - dimmable

Each arm on the same level has the same length: 3 x 250 mm = Ø 590 mm / 3 x 500 mm = Ø 1090 mm / 3 x 750 mm = Ø 1590 mm.

LED included - Suspension - IP50 Eco

*REQUIRED FOR REMOTE MOUNTING: COVER/CANOPY



cover C6

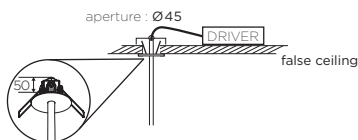

	21CO 3300	68€
	21CO 2200	68€
	21CO 1100	68€

! NOTE: cover C6 + rod RF 75 :
If the thickness of the false ceiling is 15mm, the total length of the chandelier RF 75 with cover C6 will be 1050mm.

! NOTE: cover C6 + rod RF 100 :
If the thickness of the false ceiling is 15mm, the total length of the chandelier RF 100 with cover C6 will be 1300mm.



cover C8

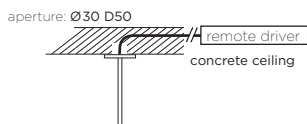

21CO 8003	80€
21CO 8002	80€
21CO 8001	80€

! NOTE: cover C8 + rod RF 75 :
the total length of the chandelier RF 75 with cover C8 will be 1078mm.

! NOTE: cover C8 + rod RF 100 :
the total length of the chandelier RF 100 with cover C8 will be 1328mm.



canopy B10

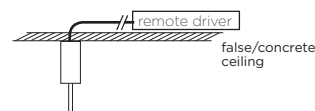

21CP 3333	222€
21CP 2222	222€
21CP 1111	222€

! NOTE: canopy B10 + rod RF 75 :
the total length of the chandelier RF 75 with canopy B10 will be 1178mm.

! NOTE: canopy B10 + rod RF 100 :
the total length of the chandelier RF 100 with canopy B10 will be 1428mm.

*REQUIRED FOR REMOTE MOUNTING: DRIVER

DEVICE	DIM.	DRIVER	NET PRICE	DEVICE	DIM.	DRIVER	NET PRICE
1 x	NO	N 80W*	27€	1 x	1-10 PU	D 80WP*	37€
					DA PU	D 80WD*	42€

*driver only fits through cutout hole of fixture with C6, min. depth for driver in false ceiling: 280mm

For warranty use only Trizo21® supplied LED drivers as mentioned.
For all specs and techs about drivers, see www.trizo21.com/drivers

LENGTH / LEVEL

LENGTH / LEVEL

LENGTH / LEVEL

FRAME
POWERCORD
STEELCABLE

FRAME
POWERCORD
STEELCABLE

FRAME
POWERCORD
STEELCABLE

FRAME
POWERCORD
STEELCABLE

RETAIL PRICE
VAT. EXCL.



REMOTE MOUNTING

AUSTERE-CHANDELIER 3Y RS 16

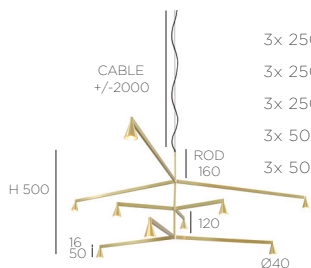

3x 250mm	&	3x 250mm	&	3x 500mm		3Y RS 22523	3Y RS 22522	3Y RS 22513	3Y RS 22512	3.313€
3x 250mm	&	3x 500mm	&	3x 500mm		3Y RS 25523	3Y RS 25522	3Y RS 25513	3Y RS 25512	3.343€
3x 250mm	&	3x 500mm	&	3x 750mm		3Y RS 25723	3Y RS 25722	3Y RS 25713	3Y RS 25712	3.376€
3x 500mm	&	3x 500mm	&	3x 750mm		3Y RS 55723	3Y RS 55722	3Y RS 55713	3Y RS 55712	3.406€
3x 500mm	&	3x 750mm	&	3x 750mm		3Y RS 57723	3Y RS 57722	3Y RS 57713	3Y RS 57712	3.439€

AUSTERE-CHANDELIER 3Y RL 79

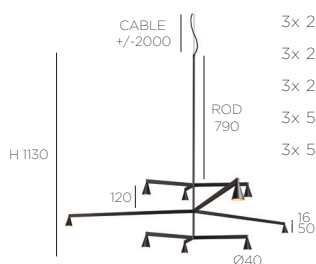

3x 250mm	&	3x 250mm	&	3x 500mm		3Y RL 22523	3Y RL 22522	3Y RL 22513	3Y RL 22512	3.343€
3x 250mm	&	3x 500mm	&	3x 500mm		3Y RL 25523	3Y RL 25522	3Y RL 25513	3Y RL 25512	3.373€
3x 250mm	&	3x 500mm	&	3x 750mm		3Y RL 25723	3Y RL 25722	3Y RL 25713	3Y RL 25712	3.406€
3x 500mm	&	3x 500mm	&	3x 750mm		3Y RL 55723	3Y RL 55722	3Y RL 55713	3Y RL 55712	3.436€
3x 500mm	&	3x 750mm	&	3x 750mm		3Y RL 57723	3Y RL 57722	3Y RL 57713	3Y RL 57712	3.469€

350mA - driver + cover/canopy required* see below

9 x LED array 6,2W - 350mA - 9 x 630lm - 2700K - CRI >98 - dimmable

Each arm on the same level has the same length: 3 x 250 mm = Ø 590 mm / 3 x 500 mm = Ø 1090 mm / 3 x 750 mm = Ø 1590 mm.

LED included - Suspension -

*REQUIRED FOR REMOTE MOUNTING: COVER/CANOPY

cover C6	cover C6	canopy B10	canopy B11
aperture: Ø45 false ceiling	aperture: Ø45 concrete ceiling	false/concrete ceiling	false/concrete ceiling
21CO 0003 68€	21CO 0013 84€	21CP 3003 222€	21CP 3033 222€
21CO 0002 68€	21CO 0012 84€	21CP 2002 222€	21CP 2022 222€
21CO 0001 68€	21CO 0011 84€	21CP 1001 222€	21CP 1011 222€

*REQUIRED FOR REMOTE MOUNTING: DRIVER

DEVICE	DIM.	DRIVER	NET PRICE	DEVICE	DIM.	DRIVER	NET PRICE
1 x	NO	N 80W*	27€	1 x	I-HO DA	D 80WP* D 80WD*	37€ 42€

*driver only fits through cutout hole of fixture with C6.
min. depth for driver in false ceiling: 280mm

For warranty use only Trizo21® supplied LED drivers as mentioned.
For all specs and techs about drivers, see www.trizo21.com/drivers

LENGTH / LEVEL

LENGTH / LEVEL

LENGTH / LEVEL

FRAME
POWERCORD
STEELCABLE

FRAME
POWERCORD
STEELCABLE

FRAME
POWERCORD
STEELCABLE

FRAME
POWERCORD
STEELCABLE

RETAIL PRICE
VAT. EXCL.



SURFACE MOUNTING

AUSTERE-CHANDELIER 3Y RS 16

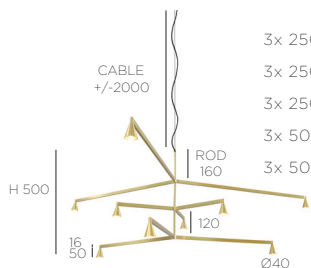

3x 250mm	&	3x 250mm	&	3x 500mm		3Y RS 22523	3Y RS 22522	3Y RS 22513	3Y RS 22512	3.313€
3x 250mm	&	3x 500mm	&	3x 500mm		3Y RS 25523	3Y RS 25522	3Y RS 25513	3Y RS 25512	3.343€
3x 250mm	&	3x 500mm	&	3x 750mm		3Y RS 25723	3Y RS 25722	3Y RS 25713	3Y RS 25712	3.376€
3x 500mm	&	3x 500mm	&	3x 750mm		3Y RS 55723	3Y RS 55722	3Y RS 55713	3Y RS 55712	3.406€
3x 500mm	&	3x 750mm	&	3x 750mm		3Y RS 57723	3Y RS 57722	3Y RS 57713	3Y RS 57712	3.439€

AUSTERE-CHANDELIER 3Y RL 79

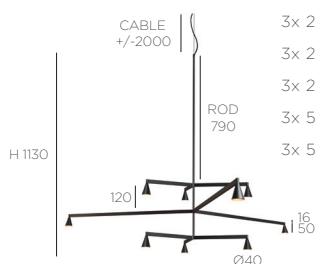

3x 250mm	&	3x 250mm	&	3x 500mm		3Y RL 22523	3Y RL 22522	3Y RL 22513	3Y RL 22512	3.343€
3x 250mm	&	3x 500mm	&	3x 500mm		3Y RL 25523	3Y RL 25522	3Y RL 25513	3Y RL 25512	3.373€
3x 250mm	&	3x 500mm	&	3x 750mm		3Y RL 25723	3Y RL 25722	3Y RL 25713	3Y RL 25712	3.406€
3x 500mm	&	3x 500mm	&	3x 750mm		3Y RL 55723	3Y RL 55722	3Y RL 55713	3Y RL 55712	3.436€
3x 500mm	&	3x 750mm	&	3x 750mm		3Y RL 57723	3Y RL 57722	3Y RL 57713	3Y RL 57712	3.469€

350mA - driver + base required* see below

9 x LED array 6,2W - 350mA - 9 x 630lm - 2700K - CRI >98 - dimmable

Each arm on the same level has the same length: 3 x 250 mm = Ø 590 mm / 3 x 500 mm = Ø 1090 mm / 3 x 750 mm = Ø 1590 mm.

LED included - Suspension - IP50

*REQUIRED FOR SURFACE MOUNTING: BASE (DRIVER INCL.)

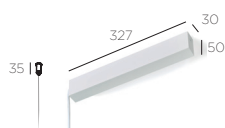

base B32

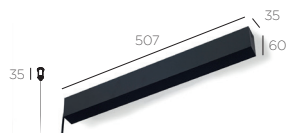
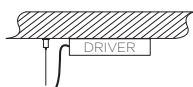

base B50

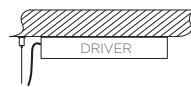

NO		BNDN 0822		365€
NO		BNDN 0811		365€

HO	PU		BDPU 0822		445€
HO	PU		BDPU 0811		445€

DA	PU		BDDA 0822		470€
DA	PU		BDDA 0811		470€

230V - driver included in base

230V - driver included in base

+ casambi possible

LENGTH
/ LEVEL

FRAME

FRAME

RETAIL PRICE
VAT. EXCL.

REMOTE MOUNTING

AUSTERE-CHANDELIER 1X RF 75 NEW

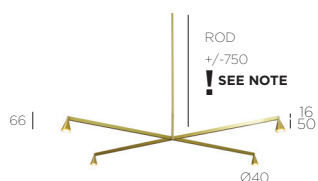

3x 250mm
 3x 500mm
 3x 750mm

1X RF7 2023	1X RF7 2022	1.478€
1X RF7 5023	1X RF7 5022	1.518€
1X RF7 7023	1X RF7 7022	1.562€

AUSTERE-CHANDELIER 1X RF 100



4x 250mm
 4x 500mm
 4x 750mm

1X RF10 2023	1X RF10 2022	1.488€
1X RF10 5023	1X RF10 5022	1.528€
1X RF10 7023	1X RF10 7022	1.572€

Shorter RF ROD available in other lengths on demand & with additional cost.

350mA - driver + cover/canopy required* see below

4 x LED array 6,2W - 350mA - 4 x 630lm - 2700K - CRI >98 - dimmable

Each arm on the same level has the same length: 4 x 250 mm = L 516 mm W 316 mm / 4 x 500 mm = L 949 mm W 565 mm / 4 x 750 mm = L 1382 mm W 815 mm.

LED included - Suspension - IP50 Eco

*REQUIRED FOR REMOTE MOUNTING: COVER/CANOPY

cover C6

aperture: Ø45

21CO 3300	68€
21CO 2200	68€
21CO 1100	68€

! NOTE: cover C6 + rod RF 75 :
 If the thickness of the false ceiling is 15mm, the total length of the chandelier RF 75 with cover C6 will be 778mm.

! NOTE: cover C6 + rod RF 100 :
 If the thickness of the false ceiling is 15mm, the total length of the chandelier RF 100 with cover C6 will be 1028mm.

cover C8

aperture: Ø30 D50

21CO 8003	80€
21CO 8002	80€
21CO 8001	80€

! NOTE: cover C8 + rod RF 75 :
 the total length of the chandelier RF 75 with cover C8 will be 806mm.

! NOTE: cover C8 + rod RF 100 :
 the total length of the chandelier RF 100 with cover C8 will be 1056mm.

canopy B10

21CP 3333	222€
21CP 2222	222€
21CP 1111	222€

! NOTE: canopy B10 + rod RF 75 :
 the total length of the chandelier RF 75 with canopy B10 will be 906mm.

! NOTE: canopy B10 + rod RF 100 :
 the total length of the chandelier RF 100 with canopy B10 will be 1156mm.

*REQUIRED FOR REMOTE MOUNTING: DRIVER

DEVICE	DIM.	DRIVER	NET PRICE	DEVICE	DIM.	DRIVER	NET PRICE
1 x	NO	N 50W *	24€	1 x	I-HO DA	PU PU	37€ 42€

* driver only fits through cutout hole of fixture with C6. min. depth for driver in false ceiling: 280mm

For warranty use only Trizo21® supplied LED drivers as mentioned. For all specs and techs about drivers, see www.trizo21.com/drivers

LENGTH / LEVEL	FRAME	POWERCORD	STEELCABLE	FRAME	POWERCORD	STEELCABLE	FRAME	POWERCORD	STEELCABLE	RETAIL PRICE VAT. EXCL.
	●	●	●	●	●	●	●	○	○	

REMOTE MOUNTING

AUSTERE-CHANDELIER 1X RS 16

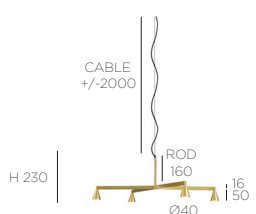

4x 250mm	1X RS 2023	1X RS 2022	1X RS 2013	1X RS 2012	1.458€
4x 500mm	1X RS 5023	1X RS 5022	1X RS 5013	1X RS 5012	1.498€
4x 750mm	1X RS 7023	1X RS 7022	1X RS 7013	1X RS 7012	1.542€

AUSTERE-CHANDELIER 1X RL 79

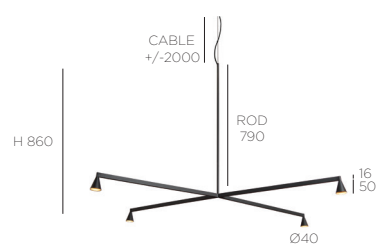

4x 250mm	1X RL 2023	1X RL 2022	1X RL 2013	1X RL 2012	1.488€
4x 500mm	1X RL 5023	1X RL 5022	1X RL 5013	1X RL 5012	1.528€
4x 750mm	1X RL 7023	1X RL 7022	1X RL 7013	1X RL 7012	1.572€

350mA - driver + cover/canopy required* see below
 4 x LED array 6.2W - 350mA - 4 x 630lm - 2700K - CRI >98 - dimmable
 Each arm on the same level has the same length: 4 x 250 mm = L 516 mm W 316 mm / 4 x 500 mm = L 949 mm W 565 mm / 4 x 750 mm = L 1382 mm W 815 mm.
 LED included - Suspension -

*REQUIRED FOR REMOTE MOUNTING: COVER/CANOPY

cover C6	cover C6	canopy B10	canopy B11
aperture: Ø45 false ceiling	aperture: Ø45 concrete ceiling	false/concrete ceiling	false/concrete ceiling
● 21CO 0003 68€	● 21CO 0013 84€	● 21CP 3003 222€	● 21CP 3033 222€
● 21CO 0002 68€	● 21CO 0012 84€	● 21CP 2002 222€	● 21CP 2022 222€
○ 21CO 0001 68€	○ 21CO 0011 84€	○ 21CP 1001 222€	○ 21CP 1011 222€

*REQUIRED FOR REMOTE MOUNTING: DRIVER

DEVICE	DIM.	DRIVER	NET PRICE	DEVICE	DIM.	DRIVER	NET PRICE
1 x	NO	N 50W*	24€	1 x	I-10 DA	D 80WP* D 80WD*	37€ 42€

*driver only fits through cutout hole of fixture with C6.
 min. depth for driver in false ceiling: 280mm

For warranty use only Trizo21® supplied LED drivers as mentioned.
 For all specs and techs about drivers, see www.trizo21.com/drivers

LENGTH / LEVEL	FRAME	POWERCORD	STEELCABLE	FRAME	POWERCORD	STEELCABLE	FRAME	POWERCORD	STEELCABLE	FRAME	POWERCORD	STEELCABLE
	●	●	●	●	●	●	●	○	○	●	○	○

RETAIL PRICE
VAT. EXCL.

SURFACE MOUNTING

AUSTERE-CHANDELIER 1X RS 16

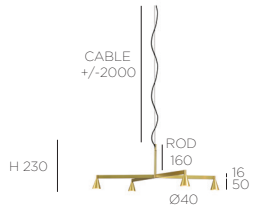

4x 250mm	1X RS 2023	1X RS 2022	1X RS 2013	1X RS 2012	1.458€
4x 500mm	1X RS 5023	1X RS 5022	1X RS 5013	1X RS 5012	1.498€
4x 750mm	1X RS 7023	1X RS 7022	1X RS 7013	1X RS 7012	1.542€

AUSTERE-CHANDELIER 1X RL 79

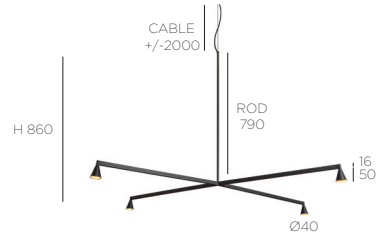

4x 250mm	1X RL 2023	1X RL 2022	1X RL 2013	1X RL 2012	1.488€
4x 500mm	1X RL 5023	1X RL 5022	1X RL 5013	1X RL 5012	1.528€
4x 750mm	1X RL 7023	1X RL 7022	1X RL 7013	1X RL 7012	1.572€

350mA - driver + base required* see below
 4 x LED array 6.2W - 350mA - 4 x 630lm - 2700K - CRI >98 - dimmable
 Each arm on the same level has the same length: 4 x 250 mm = L 516 mm W 316 mm / 4 x 500 mm = L 949 mm W 565 mm / 4 x 750 mm = L 1382 mm W 815 mm.
 LED included - Suspension -

*REQUIRED FOR SURFACE MOUNTING: BASE (DRIVER INCL.)



base B20

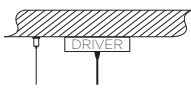

base B21

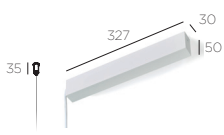
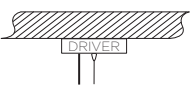

base B32

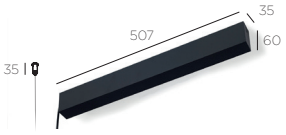
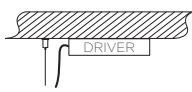

base B50

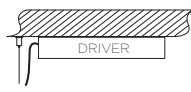

●		PU	BCPU 2402	255€	●		PU	BCPU 2422	255€	NO	BNDN 0822	365€		PU	BDPU 0822	445€
○		PU	BCPU 2401	255€	○		PU	BCPU 2411	255€	NO	BNDN 0811	365€		PU	BDPU 0811	445€
●		PU	BCDA 2402	255€			PU	BCDA 2422	255€					PU	BDDA 0822	470€
○		PU	BCDA 2401	255€			PU	BCDA 2411	255€					PU	BDDA 0811	470€

110V-230V - driver included in base + casambi possible	110V-230V - driver included in base + casambi possible	230V - driver included in base	230V - driver included in base + casambi possible
---	---	--------------------------------	--

LENGTH
/ LEVEL

LENGTH
/ LEVEL

FRAME

FRAME

RETAIL PRICE
VAT. EXCL.

REMOTE MOUNTING

AUSTERE-CHANDELIER 2X RF 75 NEW



4x 250mm & 4x 500mm
 4x 500mm & 4x 750mm

2X RF7 2523	2X RF7 2522	2.891€
2X RF7 5723	2X RF7 5722	2.975€

AUSTERE-CHANDELIER 2X RF 100

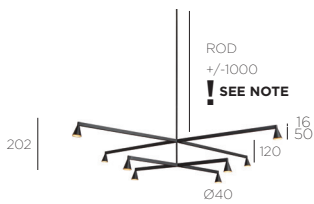

4x 250mm & 4x 500mm
 4x 500mm & 4x 750mm

2X RF10 2523	2X RF10 2522	2.901€
2X RF10 5723	2X RF10 5722	2.985€

Shorter RF ROD available in other lengths on demand & with additional cost.

350mA - driver + cover/canopy required* see below

8 x LED array 6,2W - 350mA - 8 x 630lm - 2700K - CRI >98 - dimmable

Each arm on the same level has the same length: 4 x 250 mm = L 516 mm W 316 mm / 4 x 500 mm = L 949 mm W 565 mm / 4 x 750 mm = L 1382 mm W 815 mm.

LED included - Suspension -

*REQUIRED FOR REMOTE MOUNTING: COVER/CANOPY



cover C6

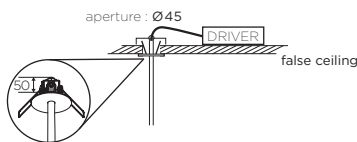

	21CO 3300	68€
	21CO 2200	68€
	21CO 1100	68€

! NOTE: cover C6 + rod RF 75 :
 If the thickness of the false ceiling is 15mm, the total length of the chandelier RF 75 with cover C6 will be 914mm.

! NOTE: cover C6 + rod RF 100 :
 If the thickness of the false ceiling is 15mm, the total length of the chandelier RF 100 with cover C6 will be 1164mm.



cover C8

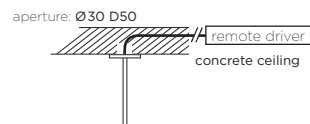

21CO 8003	80€
21CO 8002	80€
21CO 8001	80€

! NOTE: cover C8 + rod RF 75 :
 the total length of the chandelier RF 75 with cover C8 will be 942mm.

! NOTE: cover C8 + rod RF 100 :
 the total length of the chandelier RF 100 with cover C8 will be 1192mm.



canopy B10

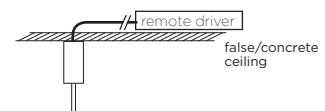

21CP 3333	222€
21CP 2222	222€
21CP 1111	222€

! NOTE: canopy B10 + rod RF 75 :
 the total length of the chandelier RF 75 with canopy B10 will be 1042mm.

! NOTE: canopy B10 + rod RF 100 :
 the total length of the chandelier RF 100 with canopy B10 will be 1292mm.

*REQUIRED FOR REMOTE MOUNTING: DRIVER

DEVICE	DIM.	DRIVER	NET PRICE	DEVICE	DIM.	DRIVER	NET PRICE
1 x	NO	N 80W*	27€	1 x	I-10 DA	D 80WP* D 80WD*	37€ 42€

* driver only fits through cutout hole of fixture with C6. min. depth for driver in false ceiling: 280mm

For warranty use only Trizo21® supplied LED drivers as mentioned. For all specs and techs about drivers, see www.trizo21.com/drivers

LENGTH / LEVEL

LENGTH / LEVEL

FRAME
POWERCORD
STEELCABLE

FRAME
POWERCORD
STEELCABLE

FRAME
POWERCORD
STEELCABLE

FRAME
POWERCORD
STEELCABLE

RETAIL PRICE
VAT. EXCL.

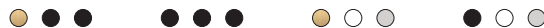

REMOTE MOUNTING

AUSTERE-CHANDELIER 2X RS 16

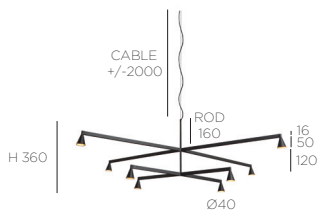

4x 250mm & 4x 500mm	2X RS 2523	2X RS 2522	2X RS 2513	2X RS 2512	2.871€
4x 500mm & 4x 750mm	2X RS 5723	2X RS 5722	2X RS 5713	2X RS 5712	2.955€

AUSTERE-CHANDELIER 2X RL 79

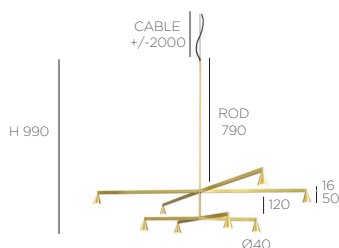

4x 250mm & 4x 500mm	2X RL 2523	2X RL 2522	2X RL 2513	2X RL 2512	2.901€
4x 500mm & 4x 750mm	2X RL 5723	2X RL 5722	2X RL 5713	2X RL 5712	2.985€

Each arm on the same level has the same length: 4 x 250 mm = L 516 mm W 316 mm / 4 x 500 mm = L 949 mm W 565 mm / 4 x 750 mm = L 1382 mm W 815 mm.

350mA - driver + cover/canopy required* see below
8 x LED array 6,2W - 350mA - 8 x 630lm - 2700K - CRI >98 - dimmable
LED included - Suspension -

*REQUIRED FOR REMOTE MOUNTING: COVER/CANOPY

	cover C6	cover C6	canopy B10	canopy B11																																			
aperture: Ø45	aperture: Ø45	aperture: Ø45																																					
DRIVER	remote driver	remote driver	remote driver	remote driver																																			
false ceiling	concrete ceiling	false/concrete ceiling	false/concrete ceiling	false/concrete ceiling																																			
<table border="0"> <tr><td>●</td><td>21CO 0003</td><td>68€</td></tr> <tr><td>●</td><td>21CO 0002</td><td>68€</td></tr> <tr><td>○</td><td>21CO 0001</td><td>68€</td></tr> </table>	●	21CO 0003	68€	●	21CO 0002	68€	○	21CO 0001	68€	<table border="0"> <tr><td>●</td><td>21CO 0013</td><td>84€</td></tr> <tr><td>●</td><td>21CO 0012</td><td>84€</td></tr> <tr><td>○</td><td>21CO 0011</td><td>84€</td></tr> </table>	●	21CO 0013	84€	●	21CO 0012	84€	○	21CO 0011	84€	<table border="0"> <tr><td>●</td><td>21CP 3003</td><td>222€</td></tr> <tr><td>●</td><td>21CP 2002</td><td>222€</td></tr> <tr><td>○</td><td>21CP 1001</td><td>222€</td></tr> </table>	●	21CP 3003	222€	●	21CP 2002	222€	○	21CP 1001	222€	<table border="0"> <tr><td>●</td><td>21CP 3033</td><td>222€</td></tr> <tr><td>●</td><td>21CP 2022</td><td>222€</td></tr> <tr><td>○</td><td>21CP 1011</td><td>222€</td></tr> </table>	●	21CP 3033	222€	●	21CP 2022	222€	○	21CP 1011	222€
●	21CO 0003	68€																																					
●	21CO 0002	68€																																					
○	21CO 0001	68€																																					
●	21CO 0013	84€																																					
●	21CO 0012	84€																																					
○	21CO 0011	84€																																					
●	21CP 3003	222€																																					
●	21CP 2002	222€																																					
○	21CP 1001	222€																																					
●	21CP 3033	222€																																					
●	21CP 2022	222€																																					
○	21CP 1011	222€																																					

*REQUIRED FOR REMOTE MOUNTING: DRIVER

DEVICE	DIM.	DRIVER	NET PRICE	DEVICE	DIM.	DRIVER	NET PRICE
1 x	NO	N 80W*	27€	1 x	I-10 DA	D 80WP* D 80WD*	37€ 42€

*driver only fits through cutout hole of fixture with C6. min. depth for driver in false ceiling: 280mm

For warranty use only Trizo21® supplied LED drivers as mentioned. For all specs and techs about drivers, see www.trizo21.com/drivers

LENGTH / LEVEL

LENGTH / LEVEL

FRAME
POWERCORD
STEELCABLE

FRAME
POWERCORD
STEELCABLE

FRAME
POWERCORD
STEELCABLE

FRAME
POWERCORD
STEELCABLE

RETAIL PRICE
VAT. EXCL.



SURFACE MOUNTING

AUSTERE-CHANDELIER 2X RS 16

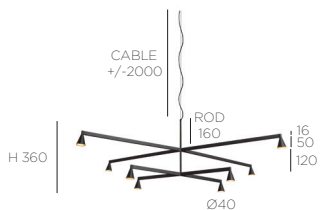

4x 250mm	&	4x 500mm		2X RS 2523	2X RS 2522	2X RS 2513	2X RS 2512		2.871€
4x 500mm	&	4x 750mm		2X RS 5723	2X RS 5722	2X RS 5713	2X RS 5712		2.955€

AUSTERE-CHANDELIER 2X RL 79

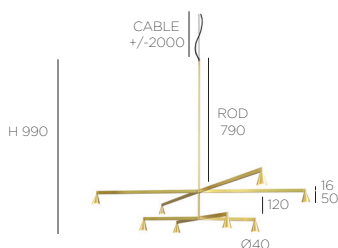

4x 250mm	&	4x 500mm		2X RL 2523	2X RL 2522	2X RL 2513	2X RL 2512		2.901€
4x 500mm	&	4x 750mm		2X RL 5723	2X RL 5722	2X RL 5713	2X RL 5712		2.985€

350mA - driver + base required* see below

8 x LED array 6,2W - 350mA - 8 x 630lm - 2700K - CRI >98 - dimmable

Each arm on the same level has the same length: 4 x 250 mm = L 516 mm W 316 mm / 4 x 500 mm = L 949 mm W 565 mm / 4 x 750 mm = L 1382 mm W 815 mm.

LED included - Suspension -

*REQUIRED FOR SURFACE MOUNTING: BASE (DRIVER INCL.)

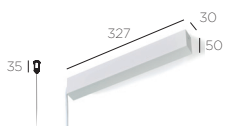

base B32

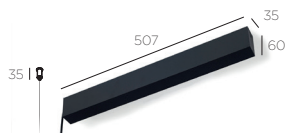
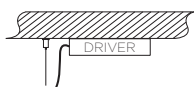

base B50

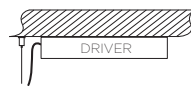

NO		BNDN 0822		365€
NO		BNDN 0811		365€

HO	PU		BDPU 0822		445€
HO	PU		BDPU 0811		445€

DA	PU		BDDA 0822		470€
DA	PU		BDDA 0811		470€

230V - driver included in base

230V - driver included in base

+ casambi possible

LENGTH / LEVEL

LENGTH / LEVEL

LENGTH / LEVEL

FRAME

FRAME

RETAIL PRICE
VAT. EXCL.

REMOTE MOUNTING

AUSTERE-CHANDELIER 3X RF 75 NEW

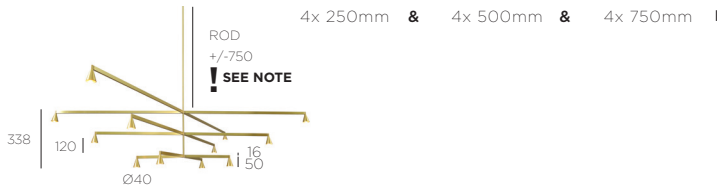

4x 250mm & 4x 500mm & 4x 750mm | 3X RF7 25723 3X RF7 25722 | 4.348€

AUSTERE-CHANDELIER 3X RF 100

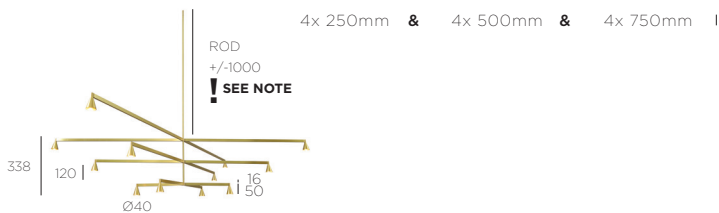

4x 250mm & 4x 500mm & 4x 750mm | 3X RF10 25723 3X RF10 25722 | 4.358€

Shorter RF ROD available in other lengths on demand & with additional cost.

350mA - driver + cover/canopy required* see below

12 x LED array 6.2W - 350mA - 12 x 630lm - 2700K - CRI >98 - dimmable

Each arm on the same level has the same length: 4 x 250 mm = L 516 mm W 316 mm / 4 x 500 mm = L 949 mm W 565 mm / 4 x 750 mm = L 1382 mm W 815 mm.

LED included - Suspension -

*REQUIRED FOR REMOTE MOUNTING: COVER/CANOPY

<p>cover C6</p> <p>aperture: Ø45</p>	<p>cover C8</p> <p>aperture: Ø30 D50</p>	<p>canopy B10</p>
<p>21CO 3300 68€</p> <p>21CO 2200 68€</p> <p>21CO 1100 68€</p>	<p>21CO 8003 80€</p> <p>21CO 8002 80€</p> <p>21CO 8001 80€</p>	<p>21CP 3333 222€</p> <p>21CP 2222 222€</p> <p>21CP 1111 222€</p>
<p>! NOTE: cover C6 + rod RF 75 : If the thickness of the false ceiling is 15mm, the total length of the chandelier RF 75 with cover C6 will be <u>1050mm</u>.</p> <p>! NOTE: cover C6 + rod RF 100 : If the thickness of the false ceiling is 15mm, the total length of the chandelier RF 100 with cover C6 will be <u>1300mm</u>.</p>	<p>! NOTE: cover C8 + rod RF 75 : the total length of the chandelier RF 75 with cover C8 will be <u>1078mm</u>.</p> <p>! NOTE: cover C8 + rod RF 100 : the total length of the chandelier RF 100 with cover C8 will be <u>1328mm</u>.</p>	<p>! NOTE: canopy B10 + rod RF 75 : the total length of the chandelier RF 75 with canopy B10 will be <u>1178mm</u>.</p> <p>! NOTE: canopy B10 + rod RF 100 : the total length of the chandelier RF 100 with canopy B10 will be <u>1428mm</u>.</p>

*REQUIRED FOR REMOTE MOUNTING: DRIVER

DEVICE	DIM.	DRIVER	NET PRICE	DEVICE	DIM.	DRIVER	NET PRICE
1 x	NO	N 80W*	27€	1 x	I-10 DA	D 80WP* D 80WD*	37€ 42€

*driver only fits through cutout hole of fixture with C6. min. depth for driver in false ceiling: 280mm

For warranty use only Trizo21® supplied LED drivers as mentioned. For all specs and techs about drivers, see www.trizo21.com/drivers

LENGTH / LEVEL

LENGTH / LEVEL

LENGTH / LEVEL

FRAME
POWERCORD
STEELCABLE

FRAME
POWERCORD
STEELCABLE

FRAME
POWERCORD
STEELCABLE

FRAME
POWERCORD
STEELCABLE

RETAIL PRICE
VAT. EXCL.



REMOTE MOUNTING

AUSTERE-CHANDELIER 3X RS 16

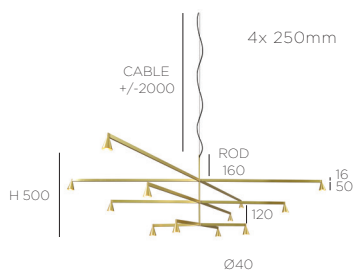

4x 250mm & 4x 500mm & 4x 750mm | 3X RS 25723 | 3X RS 25722 | 3X RS 25713 | 3X RS 25712 | 4.328€

AUSTERE-CHANDELIER 3X RL 79

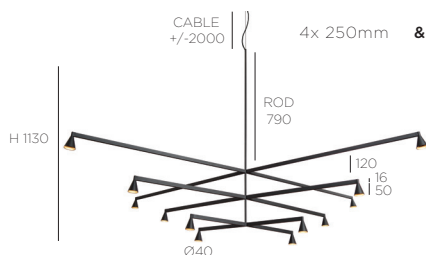

4x 250mm & 4x 500mm & 4x 750mm | 3X RL 25723 | 3X RL 25722 | 3X RL 25713 | 3X RL 25712 | 4.358€

350mA - driver + cover/canopy required* see below

12 x LED array 6.2W - 350mA - 12 x 630lm - 2700K - CRI >98 - dimmable

Each arm on the same level has the same length: 4 x 250 mm = L 516 mm W 316 mm / 4 x 500 mm = L 949 mm W 565 mm / 4 x 750 mm = L 1382 mm W 815 mm.

LED included - Suspension - IP50 eco

*REQUIRED FOR REMOTE MOUNTING: COVER/CANOPY

	cover C6	cover C6	canopy B10	canopy B11
	21CO 0003	21CO 0013	21CP 3003	21CP 3033
	21CO 0002	21CO 0012	21CP 2002	21CP 2022
	21CO 0001	21CO 0011	21CP 1001	21CP 1011
	68€	84€	222€	222€
	68€	84€	222€	222€
	68€	84€	222€	222€

*REQUIRED FOR REMOTE MOUNTING: DRIVER

DEVICE	DIM.	DRIVER	NET PRICE	DEVICE	DIM.	DRIVER	NET PRICE
1 x	NO	N 80W*	27€	1 x	I-10 DA	D 80WP*	37€
					PU	D 80WD*	42€

*driver only fits through cutout hole of fixture with C6.
min. depth for driver in false ceiling: 280mm

For warranty use only Trizo21® supplied LED drivers as mentioned.
For all specs and techs about drivers, see www.trizo21.com/drivers

LENGTH / LEVEL

LENGTH / LEVEL

LENGTH / LEVEL

FRAME
POWERCORD
STEELCABLE

FRAME
POWERCORD
STEELCABLE

FRAME
POWERCORD
STEELCABLE

FRAME
POWERCORD
STEELCABLE

RETAIL PRICE
VAT. EXCL.



SURFACE MOUNTING

AUSTERE-CHANDELIER 3X RS 16

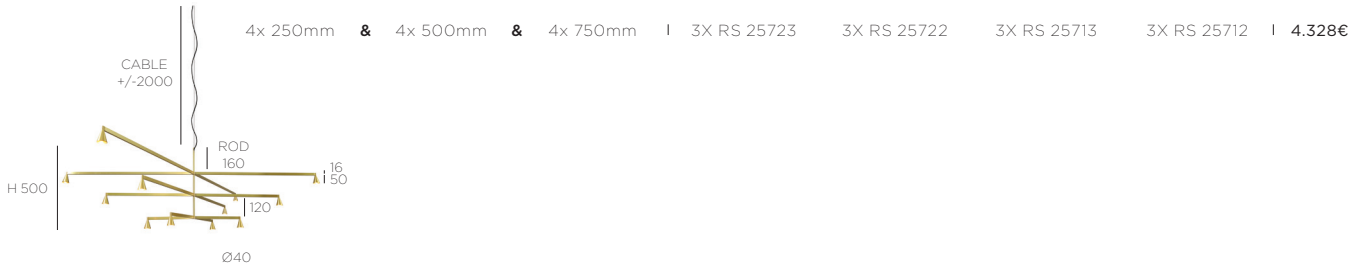

AUSTERE-CHANDELIER 3X RL 79

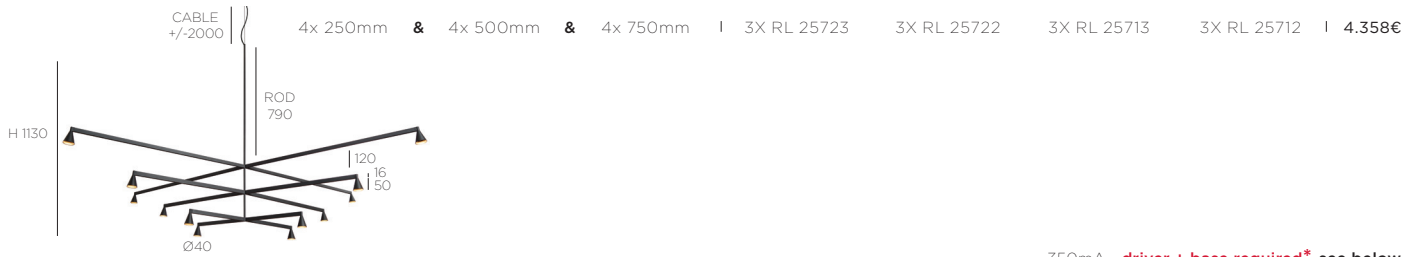

350mA - **driver + base required*** see below
 12 x LED array 6.2W - 350mA - 12 x 630lm - 2700K - CRI >98 - **dimmable**
 Each arm on the same level has the same length: 4 x 250 mm = L 516 mm W 316 mm / 4 x 500 mm = L 949 mm W 565 mm / 4 x 750 mm = L 1382 mm W 815 mm.
LED included - Suspension -

*REQUIRED FOR SURFACE MOUNTING: BASE (DRIVER INCL.)

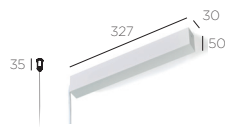

base B32

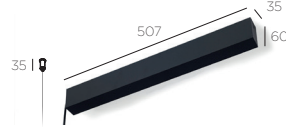
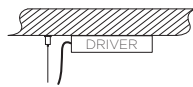

base B50

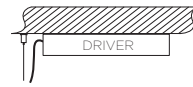

NO	BNDN 0822	365€
NO	BNDN 0811	365€

HO	PU	BDPU 0822	445€
HO	PU	BDPU 0811	445€

DA	PU	BDDA 0822	470€
DA	PU	BDDA 0811	470€

230V - **driver included in base**

230V - **driver included in base**
+ casambi possible

AUSTERE D1 2 RF 75 new

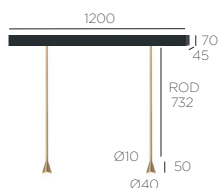

Position of the light fixture in the base can be adjusted

DIM	BASE	FRAME	FRAME	FRAME	FRAME	RETAIL PRICE VAT. EXCL.
		●	●	○	●	
NO	●	AFDN 21273	AFDN 21272	AFDN 21271		1.045€
NO	○	AFDN 21173	AFDN 21172	AFDN 21171		1.045€
NO	●				AFDN 21274	1.205€
NO	○				AFDN 21174	1.205€
LC	●	AFLC 21273	AFLC 21272	AFLC 21271		1.065€
LC	○	AFLC 21173	AFLC 21172	AFLC 21171		1.065€
LC	●				AFLC 21274	1.225€
LC	○				AFLC 21174	1.225€
1-10	PU DA	●	AFDA 21273	AFDA 21272	AFDA 21271	1.065€
1-10	PU DA	○	AFDA 21173	AFDA 21172	AFDA 21171	1.065€
1-10	PU DA	●			AFDA 21274	1.225€
1-10	PU DA	○			AFDA 21174	1.225€

230V - driver included in base - non-dimmable or TRIAC/IGBT or 1-10V or PUSH-DIM or DALI dimmable

2 x LED array 6,2W - 350mA - 2 x 630lm - 2700K - CRI >98

LED included - Suspension -

AUSTERE D1 3 RF 75 new

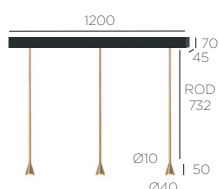

Position of the light fixture in the base can be adjusted

NO	●	AFDN 31273	AFDN 31272	AFDN 31271		1.335€
NO	○	AFDN 31173	AFDN 31172	AFDN 31171		1.335€
NO	●				AFDN 31274	1.575€
NO	○				AFDN 31174	1.575€
LC	●	AFLC 31273	AFLC 31272	AFLC 31271		1.355€
LC	○	AFLC 31173	AFLC 31172	AFLC 31171		1.355€
LC	●				AFLC 31274	1.595€
LC	○				AFLC 31174	1.595€
1-10	PU DA	●	AFDA 31273	AFDA 31272	AFDA 31271	1.355€
1-10	PU DA	○	AFDA 31173	AFDA 31172	AFDA 31171	1.355€
1-10	PU DA	●			AFDA 31274	1.595€
1-10	PU DA	○			AFDA 31174	1.595€

230V - driver included in base - non-dimmable or TRIAC/IGBT or 1-10V or PUSH-DIM or DALI dimmable

3 x LED array 6,2W - 350mA - 3 x 630lm - 2700K - CRI >98

LED included - Suspension -

AUSTERE D1 4 RF 75 new

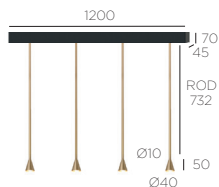

Position of the light fixture in the base can be adjusted

NO	●	AFDN 41273	AFDN 41272	AFDN 41271		1.625€
NO	○	AFDN 41173	AFDN 41172	AFDN 41171		1.625€
NO	●				AFDN 41274	1.945€
NO	○				AFDN 41174	1.945€
LC	●	AFLC 41273	AFLC 41272	AFLC 41271		1.645€
LC	○	AFLC 41173	AFLC 41172	AFLC 41171		1.645€
LC	●				AFLC 41274	1.965€
LC	○				AFLC 41174	1.965€
1-10	PU DA	●	AFDA 41273	AFDA 41272	AFDA 41271	1.645€
1-10	PU DA	○	AFDA 41173	AFDA 41172	AFDA 41171	1.645€
1-10	PU DA	●			AFDA 41274	1.965€
1-10	PU DA	○			AFDA 41174	1.965€

230V - driver included in base - non-dimmable or TRIAC/IGBT or 1-10V or PUSH-DIM or DALI dimmable

4 x LED array 6,2W - 350mA - 4 x 630lm - 2700K - CRI >98

LED included - Suspension -

AUSTERE D1 2 RF 100

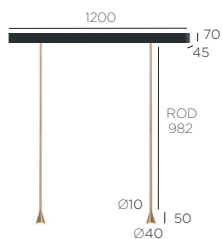

Position of the light fixture in the base can be adjusted

DIM	BASE	FRAME	FRAME	FRAME	FRAME	RETAIL PRICE VAT. EXCL.	
		●	●	○	●		
NO	●	AFDN 21293	AFDN 21292	AFDN 21291		1.065€	
NO	○	AFDN 21193	AFDN 21192	AFDN 21191		1.065€	
NO	●				AFDN 21294	1.225€	
NO	○				AFDN 21194	1.225€	
LC	●	AFLC 21293	AFLC 21292	AFLC 21291		1.085€	
LC	○	AFLC 21193	AFLC 21192	AFLC 21191		1.085€	
LC	●				AFLC 21294	1.245€	
LC	○				AFLC 21194	1.245€	
1-10	PU DA	●	AFDA 21293	AFDA 21292	AFDA 21291	1.085€	
1-10	PU DA	○	AFDA 21193	AFDA 21192	AFDA 21191	1.085€	
1-10	PU DA	●				AFDA 21294	1.245€
1-10	PU DA	○				AFDA 21194	1.245€

230V - driver included in base - non-dimmable or TRIAC/IGBT or 1-10V or PUSH-DIM or DALI dimmable

2 x LED array 6.2W - 350mA - 2 x 630lm - 2700K - CRI >98

LED included - Suspension -

AUSTERE D1 3 RF 100

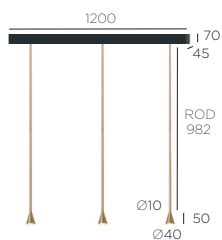

Position of the light fixture in the base can be adjusted

NO	●	AFDN 31293	AFDN 31292	AFDN 31291		1.365€	
NO	○	AFDN 31193	AFDN 31192	AFDN 31191		1.365€	
NO	●				AFDN 31294	1.605€	
NO	○				AFDN 31194	1.605€	
LC	●	AFLC 31293	AFLC 31292	AFLC 31291		1.385€	
LC	○	AFLC 31193	AFLC 31192	AFLC 31191		1.385€	
LC	●				AFLC 31294	1.625€	
LC	○				AFLC 31194	1.625€	
1-10	PU DA	●	AFDA 31293	AFDA 31292	AFDA 31291	1.385€	
1-10	PU DA	○	AFDA 31193	AFDA 31192	AFDA 31191	1.385€	
1-10	PU DA	●				AFDA 31294	1.625€
1-10	PU DA	○				AFDA 31194	1.625€

230V - driver included in base - non-dimmable or TRIAC/IGBT or 1-10V or PUSH-DIM or DALI dimmable

3 x LED array 6.2W - 350mA - 3 x 630lm - 2700K - CRI >98

LED included - Suspension -

AUSTERE D1 4 RF 100

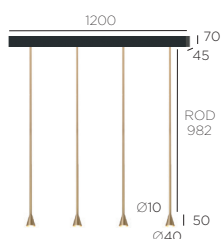

Position of the light fixture in the base can be adjusted

NO	●	AFDN 41293	AFDN 41292	AFDN 41291		1.665€	
NO	○	AFDN 41193	AFDN 41192	AFDN 41191		1.665€	
NO	●				AFDN 41294	1.985€	
NO	○				AFDN 41194	1.985€	
LC	●	AFLC 41293	AFLC 41292	AFLC 41291		1.685€	
LC	○	AFLC 41193	AFLC 41192	AFLC 41191		1.685€	
LC	●				AFLC 41294	2.005€	
LC	○				AFLC 41194	2.005€	
1-10	PU DA	●	AFDA 41293	AFDA 41292	AFDA 41291	1.685€	
1-10	PU DA	○	AFDA 41193	AFDA 41192	AFDA 41191	1.685€	
1-10	PU DA	●				AFDA 41294	2.005€
1-10	PU DA	○				AFDA 41194	2.005€

230V - driver included in base - non-dimmable or TRIAC/IGBT or 1-10V or PUSH-DIM or DALI dimmable

4 x LED array 6.2W - 350mA - 4 x 630lm - 2700K - CRI >98

LED included - Suspension -

AUSTERE D2 4 RF 75 new

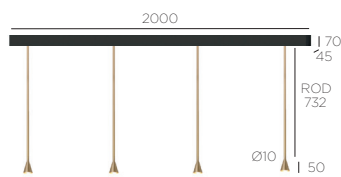

Position of the light fixture in the base can be adjusted

DIM	BASE	FRAME	FRAME	FRAME	FRAME	RETAIL PRICE VAT. EXCL.	
		●	●	○	●		
NO	●	AFDN 42273	AFDN 42272	AFDN 42271		1.925€	
NO	○	AFDN 42173	AFDN 42172	AFDN 42171		1.925€	
NO	●				AFDN 42274	2.245€	
NO	○				AFDN 42174	2.245€	
LC	●	AFLC 42273	AFLC 42272	AFLC 42271		1.945€	
LC	○	AFLC 42173	AFLC 42172	AFLC 42171		1.945€	
LC	●				AFLC 42274	2.275€	
LC	○				AFLC 42174	2.275€	
1-10	PU DA	●	AFDA 42273	AFDA 42272	AFDA 42271	1.945€	
1-10	PU DA	○	AFDA 42173	AFDA 42172	AFDA 42171	1.945€	
1-10	PU DA	●				AFDA 42274	2.275€
1-10	PU DA	○				AFDA 42174	2.275€

230V - driver included in base - non-dimmable or TRIAC/IGBT or 1-10V or PUSH-DIM or DALI dimmable

4 x LED array 6.2W - 350mA - 4 x 630lm - 2700K - CRI >98

LED included - Suspension -

AUSTERE D2 5 RF 75 new

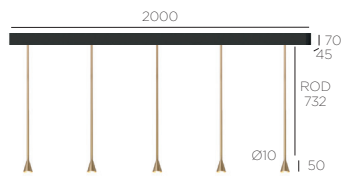

Position of the light fixture in the base can be adjusted

NO	●	AFDN 52273	AFDN 52272	AFDN 52271		2.215€	
NO	○	AFDN 52173	AFDN 52172	AFDN 52171		2.215€	
NO	●				AFDN 52274	2.615€	
NO	○				AFDN 52174	2.615€	
LC	●	AFLC 52273	AFLC 52272	AFLC 52271		2.235€	
LC	○	AFLC 52173	AFLC 52172	AFLC 52171		2.235€	
LC	●				AFLC 52274	2.645€	
LC	○				AFLC 52174	2.645€	
1-10	PU DA	●	AFDA 52273	AFDA 52272	AFDA 52271	2.235€	
1-10	PU DA	○	AFDA 52173	AFDA 52172	AFDA 52171	2.235€	
1-10	PU DA	●				AFDA 52274	2.645€
1-10	PU DA	○				AFDA 52174	2.645€

230V - driver included in base - non-dimmable or TRIAC/IGBT or 1-10V or PUSH-DIM or DALI dimmable

5 x LED array 6.2W - 350mA - 5 x 630lm - 2700K - CRI >98

LED included - Suspension -

AUSTERE D2 6 RF 75 new

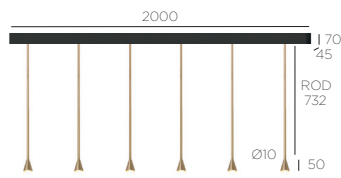

Position of the light fixture in the base can be adjusted

NO	●	AFDN 62273	AFDN 62272	AFDN 62271		2.505€	
NO	○	AFDN 62173	AFDN 62172	AFDN 62171		2.505€	
NO	●				AFDN 62274	2.985€	
NO	○				AFDN 62174	2.985€	
LC	●	AFLC 62273	AFLC 62272	AFLC 62271		2.525€	
LC	○	AFLC 62173	AFLC 62172	AFLC 62171		2.525€	
LC	●				AFLC 62274	3.015€	
LC	○				AFLC 62174	3.015€	
1-10	PU DA	●	AFDA 62273	AFDA 62272	AFDA 62271	2.525€	
1-10	PU DA	○	AFDA 62173	AFDA 62172	AFDA 62171	2.525€	
1-10	PU DA	●				AFDA 62274	3.015€
1-10	PU DA	○				AFDA 62174	3.015€

230V - driver included in base - non-dimmable or TRIAC/IGBT or 1-10V or PUSH-DIM or DALI dimmable

6 x LED array 6.2W - 350mA - 6 x 630lm - 2700K - CRI >98

LED included - Suspension -

AUSTERE D2 4 RF 100

new

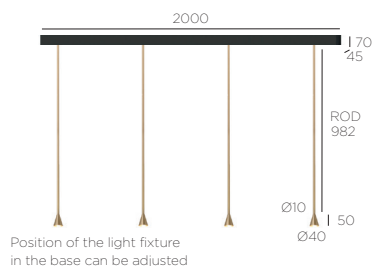

DIM	BASE	FRAME	FRAME	FRAME	FRAME	RETAIL PRICE VAT. EXCL.	
		●	●	○	●		
NO	●	AFDN 42293	AFDN 42292	AFDN 42291		1.965€	
NO	○	AFDN 42193	AFDN 42192	AFDN 42191		1.965€	
NO	●				AFDN 42294	2.285€	
NO	○				AFDN 42194	2.285€	
LC	●	AFLC 42293	AFLC 42292	AFLC 42291		1.985€	
LC	○	AFLC 42193	AFLC 42192	AFLC 42191		1.985€	
LC	●				AFLC 42294	2.315€	
LC	○				AFLC 42194	2.315€	
1-10	PU DA	●	AFDA 42293	AFDA 42292	AFDA 42291	1.985€	
1-10	PU DA	○	AFDA 42193	AFDA 42192	AFDA 42191	1.985€	
1-10	PU DA	●				AFDA 42294	2.315€
1-10	PU DA	○				AFDA 42194	2.315€

230V - driver included in base - non-dimmable or TRIAC/IGBT or 1-10V or PUSH-DIM or DALI dimmable

4 x LED array 6.2W - 350mA - 4 x 630lm - 2700K - CRI >98

LED included - Suspension - CE IP50 eco

AUSTERE D2 5 RF 100

new

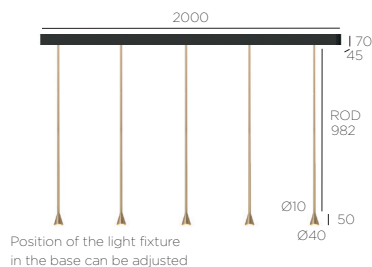

NO	●	AFDN 52293	AFDN 52292	AFDN 52291		2.265€	
NO	○	AFDN 52193	AFDN 52192	AFDN 52191		2.265€	
NO	●				AFDN 52294	2.665€	
NO	○				AFDN 52194	2.665€	
LC	●	AFLC 52293	AFLC 52292	AFLC 52291		2.285€	
LC	○	AFLC 52193	AFLC 52192	AFLC 52191		2.285€	
LC	●				AFLC 52294	2.695€	
LC	○				AFLC 52194	2.695€	
1-10	PU DA	●	AFDA 52293	AFDA 52292	AFDA 52291	2.285€	
1-10	PU DA	○	AFDA 52193	AFDA 52192	AFDA 52191	2.285€	
1-10	PU DA	●				AFDA 52294	2.695€
1-10	PU DA	○				AFDA 52194	2.695€

230V - driver included in base - non-dimmable or TRIAC/IGBT or 1-10V or PUSH-DIM or DALI dimmable

5 x LED array 6.2W - 350mA - 5 x 630lm - 2700K - CRI >98

LED included - Suspension - CE IP50 eco

AUSTERE D2 6 RF 100

new

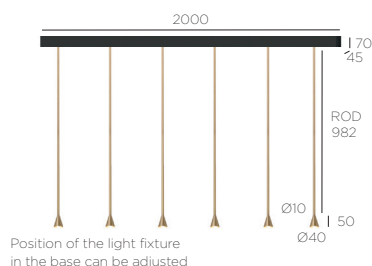

NO	●	AFDN 62293	AFDN 62292	AFDN 62291		2.565€	
NO	○	AFDN 62193	AFDN 62192	AFDN 62191		2.565€	
NO	●				AFDN 62294	3.045€	
NO	○				AFDN 62194	3.045€	
LC	●	AFLC 62293	AFLC 62292	AFLC 62291		2.585€	
LC	○	AFLC 62193	AFLC 62192	AFLC 62191		2.585€	
LC	●				AFLC 62294	3.075€	
LC	○				AFLC 62194	3.075€	
1-10	PU DA	●	AFDA 62293	AFDA 62292	AFDA 62291	2.585€	
1-10	PU DA	○	AFDA 62193	AFDA 62192	AFDA 62191	2.585€	
1-10	PU DA	●				AFDA 62294	3.075€
1-10	PU DA	○				AFDA 62194	3.075€

230V - driver included in base - non-dimmable or TRIAC/IGBT or 1-10V or PUSH-DIM or DALI dimmable

6 x LED array 6.2W - 350mA - 6 x 630lm - 2700K - CRI >98

LED included - Suspension - CE IP50 eco

AUSTERE D1 2 RL

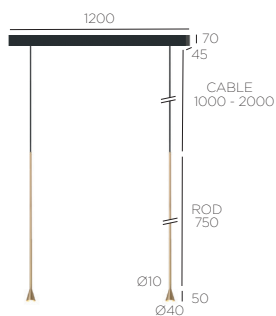

Position of the light fixture in the base can be adjusted

DIM	BASE	CABLE LENGTH	FRAME	CABLE	FRAME	CABLE	FRAME	CABLE	FRAME	CABLE	RETAIL PRICE VAT. EXCL.
NO	●	L 1000	ALDN 21213	ALDN 21212	ALDN 21211						1.135€
NO	●	L 2000	ALDN 21223	ALDN 21222	ALDN 21221						1.155€
NO	●	L 1000						ALDN 21214			1.295€
NO	●	L 2000						ALDN 21224			1.315€
NO	○	L 1000	ALDN 21113	ALDN 21112	ALDN 21111						1.135€
NO	○	L 2000	ALDN 21123	ALDN 21122	ALDN 21121						1.155€
NO	○	L 1000						ALDN 21114			1.295€
NO	○	L 2000						ALDN 21124			1.315€
LC	●	L 1000	ALLC 21213	ALLC 21212	ALLC 21211						1.155€
LC	●	L 2000	ALLC 21223	ALLC 21222	ALLC 21221						1.175€
LC	●	L 1000						ALLC 21214			1.315€
LC	●	L 2000						ALLC 21224			1.335€
LC	○	L 1000	ALLC 21113	ALLC 21112	ALLC 21111						1.155€
LC	○	L 2000	ALLC 21123	ALLC 21122	ALLC 21121						1.175€
LC	○	L 1000						ALLC 21114			1.315€
LC	○	L 2000						ALLC 21124			1.335€
1-10 PU DA	●	L 1000	ALDA 21213	ALDA 21212	ALDA 21211						1.155€
1-10 PU DA	●	L 2000	ALDA 21223	ALDA 21222	ALDA 21221						1.175€
1-10 PU DA	●	L 1000						ALDA 21214			1.315€
1-10 PU DA	●	L 2000						ALDA 21224			1.335€
1-10 PU DA	○	L 1000	ALDA 21113	ALDA 21112	ALDA 21111						1.155€
1-10 PU DA	○	L 2000	ALDA 21123	ALDA 21122	ALDA 21121						1.175€
1-10 PU DA	○	L 1000						ALDA 21114			1.315€
1-10 PU DA	○	L 2000						ALDA 21124			1.335€

230V - driver included in base - non-dimmable or TRIAC/IGBT or 1-10V or PUSH-DIM or DALI dimmable

2 x LED array 6.2W - 350mA - 2 x 630lm - 2700K - CRI >98

Other cable lengths available on demand. - LED included - Suspension -

AUSTERE D1 3 RL

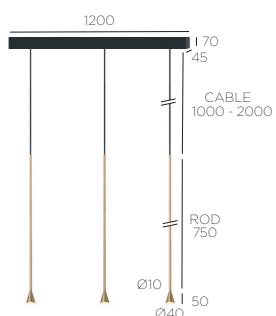

Position of the light fixture in the base can be adjusted

DIM	BASE	CABLE LENGTH	FRAME	CABLE	FRAME	CABLE	FRAME	CABLE	FRAME	CABLE	RETAIL PRICE VAT. EXCL.
NO	●	L 1000	ALDN 31213	ALDN 31212	ALDN 31211						1.470€
NO	●	L 2000	ALDN 31223	ALDN 31222	ALDN 31221						1.500€
NO	●	L 1000						ALDN 31214			1.710€
NO	●	L 2000						ALDN 31224			1.740€
NO	○	L 1000	ALDN 31113	ALDN 31112	ALDN 31111						1.470€
NO	○	L 2000	ALDN 31123	ALDN 31122	ALDN 31121						1.500€
NO	○	L 1000						ALDN 31114			1.710€
NO	○	L 2000						ALDN 31124			1.740€
LC	●	L 1000	ALLC 31213	ALLC 31212	ALLC 31211						1.490€
LC	●	L 2000	ALLC 31223	ALLC 31222	ALLC 31221						1.520€
LC	●	L 1000						ALLC 31214			1.730€
LC	●	L 2000						ALLC 31224			1.760€
LC	○	L 1000	ALLC 31113	ALLC 31112	ALLC 31111						1.490€
LC	○	L 2000	ALLC 31123	ALLC 31122	ALLC 31121						1.520€
LC	○	L 1000						ALLC 31114			1.730€
LC	○	L 2000						ALLC 31124			1.760€
1-10 PU DA	●	L 1000	ALDA 31213	ALDA 31212	ALDA 31211						1.490€
1-10 PU DA	●	L 2000	ALDA 31223	ALDA 31222	ALDA 31221						1.520€
1-10 PU DA	●	L 1000						ALDA 31214			1.730€
1-10 PU DA	●	L 2000						ALDA 31224			1.760€
1-10 PU DA	○	L 1000	ALDA 31113	ALDA 31112	ALDA 31111						1.490€
1-10 PU DA	○	L 2000	ALDA 31123	ALDA 31122	ALDA 31121						1.520€
1-10 PU DA	○	L 1000						ALDA 31114			1.730€
1-10 PU DA	○	L 2000						ALDA 31124			1.760€

230V - driver included in base - non-dimmable or TRIAC/IGBT or 1-10V or PUSH-DIM or DALI dimmable

3 x LED array 6.2W - 350mA - 3 x 630lm - 2700K - CRI >98

Other cable lengths available on demand. - LED included - Suspension -

AUSTERE D1 4 RL

new

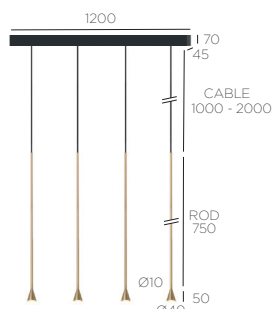

Position of the light fixture in the base can be adjusted

DIM	BASE	CABLE LENGTH	FRAME		CABLE		FRAME		CABLE		FRAME		CABLE		RETAIL PRICE VAT. EXCL.
			●	●	●	●	○	○	●	●	○	○			
NO	●	L 1000	ALDN 41213	ALDN 41212	ALDN 41211									1.805€	
NO	●	L 2000	ALDN 41223	ALDN 41222	ALDN 41221									1.845€	
NO	●	L 1000										ALDN 41214		2.125€	
NO	●	L 2000										ALDN 41224		2.165€	
NO	○	L 1000	ALDN 41113	ALDN 41112	ALDN 41111									1.805€	
NO	○	L 2000	ALDN 41123	ALDN 41122	ALDN 41121									1.845€	
NO	○	L 1000										ALDN 41114		2.125€	
NO	○	L 2000										ALDN 41124		2.165€	
LC	●	L 1000	ALLC 41213	ALLC 41212	ALLC 41211									1.825€	
LC	●	L 2000	ALLC 41223	ALLC 41222	ALLC 41221									1.865€	
LC	●	L 1000										ALLC 41214		2.145€	
LC	●	L 2000										ALLC 41224		2.185€	
LC	○	L 1000	ALLC 41113	ALLC 41112	ALLC 41111									1.825€	
LC	○	L 2000	ALLC 41123	ALLC 41122	ALLC 41121									1.865€	
LC	○	L 1000										ALLC 41114		2.145€	
LC	○	L 2000										ALLC 41124		2.185€	
1-10 PU DA	●	L 1000	ALDA 41213	ALDA 41212	ALDA 41211									1.825€	
1-10 PU DA	●	L 2000	ALDA 41223	ALDA 41222	ALDA 41221									1.865€	
1-10 PU DA	●	L 1000										ALDA 41214		2.145€	
1-10 PU DA	●	L 2000										ALDA 41224		2.185€	
1-10 PU DA	○	L 1000	ALDA 41113	ALDA 41112	ALDA 41111									1.825€	
1-10 PU DA	○	L 2000	ALDA 41123	ALDA 41122	ALDA 41121									1.865€	
1-10 PU DA	○	L 1000										ALDA 41114		2.145€	
1-10 PU DA	○	L 2000										ALDA 41124		2.185€	

230V - driver included in base - non-dimmable or TRIAC/IGBT or 1-10V or PUSH-DIM or DALI dimmable

4 x LED array 6.2W - 350mA - 4 x 630lm - 2700K - CRI >98

Other cable lengths available on demand. - LED included - Suspension -

AUSTERE D2 4 RL

new

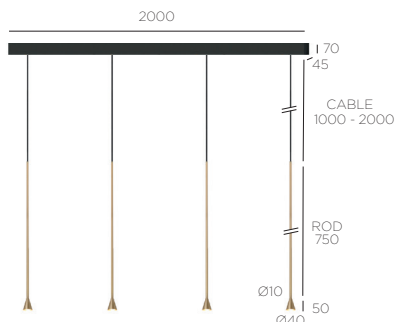

Position of the light fixture in the base can be adjusted

NO	●	L 1000	ALDN 42213	ALDN 42212	ALDN 42211									2.105€
NO	●	L 2000	ALDN 42223	ALDN 42222	ALDN 42221									2.145€
NO	●	L 1000										ALDN 42214		2.425€
NO	●	L 2000										ALDN 42224		2.465€
NO	○	L 1000	ALDN 42113	ALDN 42112	ALDN 42111									2.105€
NO	○	L 2000	ALDN 42123	ALDN 42122	ALDN 42121									2.145€
NO	○	L 1000										ALDN 42114		2.425€
NO	○	L 2000										ALDN 42124		2.465€
LC	●	L 1000	ALLC 42213	ALLC 42212	ALLC 42211									2.125€
LC	●	L 2000	ALLC 42223	ALLC 42222	ALLC 42221									2.165€
LC	●	L 1000										ALLC 42214		2.455€
LC	●	L 2000										ALLC 42224		2.495€
LC	○	L 1000	ALLC 42113	ALLC 42112	ALLC 42111									2.125€
LC	○	L 2000	ALLC 42123	ALLC 42122	ALLC 42121									2.165€
LC	○	L 1000										ALLC 42114		2.455€
LC	○	L 2000										ALLC 42124		2.495€
1-10 PU DA	●	L 1000	ALDA 42213	ALDA 42212	ALDA 42211									2.125€
1-10 PU DA	●	L 2000	ALDA 42223	ALDA 42222	ALDA 42221									2.165€
1-10 PU DA	●	L 1000										ALDA 42214		2.455€
1-10 PU DA	●	L 2000										ALDA 42224		2.495€
1-10 PU DA	○	L 1000	ALDA 42113	ALDA 42112	ALDA 42111									2.125€
1-10 PU DA	○	L 2000	ALDA 42123	ALDA 42122	ALDA 42121									2.165€
1-10 PU DA	○	L 1000										ALDA 42114		2.455€
1-10 PU DA	○	L 2000										ALDA 42124		2.495€

230V - driver included in base - non-dimmable or TRIAC/IGBT or 1-10V or PUSH-DIM or DALI dimmable

4 x LED array 6.2W - 350mA - 4 x 630lm - 2700K - CRI >98

Other cable lengths available on demand. - LED included - Suspension -

AUSTERE D2 5 RL

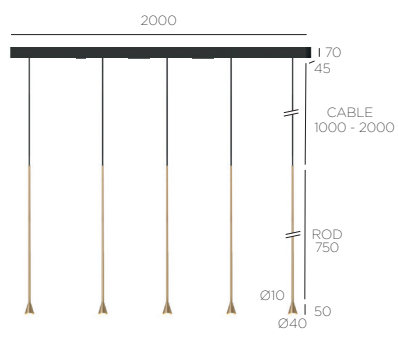

DIM	BASE	CABLE LENGTH	FRAME	CABLE	FRAME	CABLE	FRAME	CABLE	FRAME	CABLE	RETAIL PRICE VAT. EXCL.
NO	●	L 1000	ALDN 52213	ALDN 52212	ALDN 52211						2.440€
NO	●	L 2000	ALDN 52223	ALDN 52222	ALDN 52221						2.490€
NO	●	L 1000						ALDN 52214			2.840€
NO	●	L 2000						ALDN 52224			2.890€
NO	○	L 1000	ALDN 52113	ALDN 52112	ALDN 52111						2.440€
NO	○	L 2000	ALDN 52123	ALDN 52122	ALDN 52121						2.490€
NO	○	L 1000						ALDN 52114			2.840€
NO	○	L 2000						ALDN 52124			2.890€
LC	●	L 1000	ALLC 52213	ALLC 52212	ALLC 52211						2.460€
LC	●	L 2000	ALLC 52223	ALLC 52222	ALLC 52221						2.520€
LC	●	L 1000						ALLC 52214			2.870€
LC	●	L 2000						ALLC 52224			2.920€
LC	○	L 1000	ALLC 52113	ALLC 52112	ALLC 52111						2.460€
LC	○	L 2000	ALLC 52123	ALLC 52122	ALLC 52121						2.520€
LC	○	L 1000						ALLC 52114			2.870€
LC	○	L 2000						ALLC 52124			2.920€
1-10 PU DA	●	L 1000	ALDA 52213	ALDA 52212	ALDA 52211						2.460€
1-10 PU DA	●	L 2000	ALDA 52223	ALDA 52222	ALDA 52221						2.520€
1-10 PU DA	●	L 1000						ALDA 52214			2.870€
1-10 PU DA	●	L 2000						ALDA 52224			2.920€
1-10 PU DA	○	L 1000	ALDA 52113	ALDA 52112	ALDA 52111						2.460€
1-10 PU DA	○	L 2000	ALDA 52123	ALDA 52122	ALDA 52121						2.520€
1-10 PU DA	○	L 1000						ALDA 52114			2.870€
1-10 PU DA	○	L 2000						ALDA 52124			2.920€

230V - driver included in base - non-dimmable or TRIAC/IGBT or 1-10V or PUSH-DIM or DALI dimmable

5 x LED array 6.2W - 350mA - 5 x 630lm - 2700K - CRI >98

Other cable lengths available on demand. - LED included - Suspension -

AUSTERE D2 6 RL

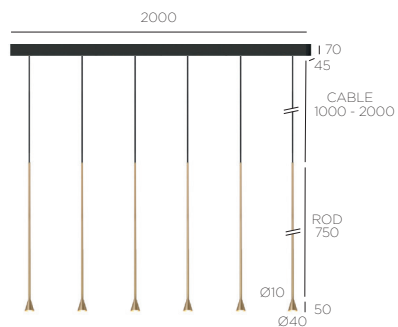

NO	●	L 1000	ALDN 62213	ALDN 62212	ALDN 62211						2.775€
NO	●	L 2000	ALDN 62223	ALDN 62222	ALDN 62221						2.835€
NO	●	L 1000						ALDN 62214			3.255€
NO	●	L 2000						ALDN 62224			3.315€
NO	○	L 1000	ALDN 62113	ALDN 62112	ALDN 62111						2.775€
NO	○	L 2000	ALDN 62123	ALDN 62122	ALDN 62121						2.835€
NO	○	L 1000						ALDN 62114			3.255€
NO	○	L 2000						ALDN 62124			3.315€
LC	●	L 1000	ALLC 62213	ALLC 62212	ALLC 62211						2.805€
LC	●	L 2000	ALLC 62223	ALLC 62222	ALLC 62221						2.865€
LC	●	L 1000						ALLC 62214			3.285€
LC	●	L 2000						ALLC 62224			3.345€
LC	○	L 1000	ALLC 62113	ALLC 62112	ALLC 62111						2.805€
LC	○	L 2000	ALLC 62123	ALLC 62122	ALLC 62121						2.865€
LC	○	L 1000						ALLC 62114			3.285€
LC	○	L 2000						ALLC 62124			3.345€
1-10 PU DA	●	L 1000	ALDA 62213	ALDA 62212	ALDA 62211						2.805€
1-10 PU DA	●	L 2000	ALDA 62223	ALDA 62222	ALDA 62221						2.865€
1-10 PU DA	●	L 1000						ALDA 62214			3.285€
1-10 PU DA	●	L 2000						ALDA 62224			3.345€
1-10 PU DA	○	L 1000	ALDA 62113	ALDA 62112	ALDA 62111						2.805€
1-10 PU DA	○	L 2000	ALDA 62123	ALDA 62122	ALDA 62121						2.865€
1-10 PU DA	○	L 1000						ALDA 62114			3.285€
1-10 PU DA	○	L 2000						ALDA 62124			3.345€

230V - driver included in base - non-dimmable or TRIAC/IGBT or 1-10V or PUSH-DIM or DALI dimmable

6 x LED array 6.2W - 350mA - 6 x 630lm - 2700K - CRI >98

Other cable lengths available on demand. - LED included - Suspension -

DIM	FRAME COVER	FRAME COVER	FRAME COVER	FRAME COVER	Driver excl. RETAIL PRICE VAT. EXCL.
	● ●	● ●	○ ○	● ●	

AUSTERE-SOLITAIRE RF (for false ceiling)

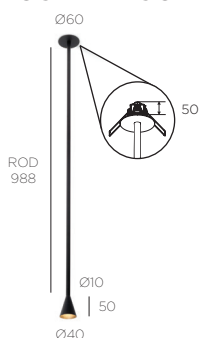

HVSU 1003	HVSU 1002	HVSU 1001	I	345€
			HVSU 1004	I 425€

RF = fixed vertical rod of max. 988mm (possibility to shorten with tube cutter)
 350mA - **driver required (remote mounting) see below**
 1 x LED array 6,2W - 350mA - 630lm - 2700K - CRI >98 - **dimmable**
 aperture : Ø 45 - depth : min. 50 mm, depth for driver in ceiling : min. 70 mm
LED included - Suspension -

REQUIRED DRIVER (REMOTE MOUNTING)

DEVICE	DIM.	DRIVER	NET PRICE	DEVICE	DIM.	DRIVER	NET PRICE
1 x	NO	N 6W	11,20€	1-2 x	HO PU	D 15WP*	20,65€
	LC	D 10WT	14,65€		DA	D 15WDA*	22,60€
2 x	LC	D 18WT	16,95€	2-6 x	HO PU	D 40WP*	44,65€
					HO PU DA	D 40WDA*	46,65€

driver does not fit through cutout hole of fixture
 *110V-230V

**For warranty use only Trizo21® supplied LED drivers as mentioned.
 For all specs and techs about drivers, see www.trizo21.com/drivers**

AUSTERE-SOLITAIRE RFC (for concrete ceiling)

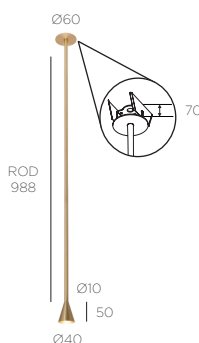

HVSC 1003	HVSC 1002	HVSC 1001	I	355€
			HVSC 1004	I 435€

RF = fixed vertical rod of max. 988mm (possibility to shorten with tube cutter)
 350mA - **driver required (remote mounting) see below**
 1 x LED array 6,2W - 350mA - 630lm - 2700K - CRI >98 - **dimmable**
 aperture : Ø 45 - depth : min. 70 mm, depth for driver in ceiling : min. 110 mm
LED included - Suspension -

REQUIRED DRIVER (REMOTE MOUNTING)

DEVICE	DIM.	DRIVER	NET PRICE	DEVICE	DIM.	DRIVER	NET PRICE
1 x	NO	N 6W	11,20€	1-2 x	HO PU	D 15WP*	20,65€
	LC	D 10WT	14,65€		DA	D 15WDA*	22,60€
2 x	LC	D 18WT	16,95€	2-6 x	HO PU	D 40WP*	44,65€
					HO PU DA	D 40WDA*	46,65€

driver does not fit through cutout hole of fixture
 *110V-230V

**For warranty use only Trizo21® supplied LED drivers as mentioned.
 For all specs and techs about drivers, see www.trizo21.com/drivers**

AUSTERE-SOLITAIRE RF D+B

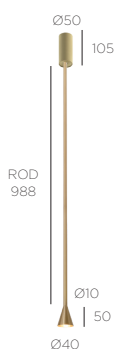

NO*	I	HVSBD 1103	HVSBD 1102	HVSBD 1101	I	555€
LC	I	HVSBD 1113	HVSBD 1112	HVSBD 1111	I	565€

RF = fixed vertical rod of max. 988mm (possibility to shorten with tube cutter)
 *110V-230V - **driver included in base - non-dimmable**
 230V - **driver included in base - TRIAC/IGBT dimmable**
 1 x LED array 6,2W - 350mA - 630lm - 2700K - CRI >98
LED included - Suspension -

DIM	CABLE LENGTH	FRAME	COVER	CABLE	FRAME	COVER	CABLE	FRAME	COVER	CABLE	FRAME	COVER	CABLE	Driver excl. RETAIL PRICE VAT. EXCL.
		●	●	●	●	●	●	○	○	○	●	●	●	

AUSTERE-SOLITAIRE RL (for false ceiling)

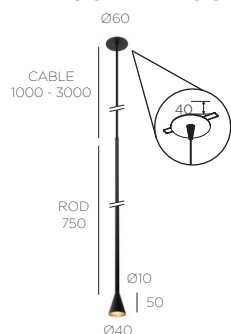

L 1000	HVCA 3013	HVCA 3012	HVCA 3011	380€
L 2000	HVCA 3023	HVCA 3022	HVCA 3021	390€
L 3000	HVCA 3033	HVCA 3032	HVCA 3031	400€
L 1000			HVCA 3014	460€
L 2000			HVCA 3024	470€
L 3000			HVCA 3034	480€

RL = long vertical rod of 750 mm + powercord - Other cable lengths available on demand.
 350mA - **driver required (remote mounting) see below**
 1 x LED array 6,2W - 350mA - 630lm - 2700K - CRI >98 - **dimnable**
 aperture : Ø 45 - depth : min. 40 mm - depth for driver in ceiling : min. 70 mm
LED included - Suspension -

REQUIRED DRIVER (REMOTE MOUNTING)

DEVICE	DIM.	DRIVER	NET PRICE	DEVICE	DIM.	DRIVER	NET PRICE
1 x	NO	N 6W	11,20€	1-2 x	1-10 PU	D 15WP*	20,65€
	LC	D 10WT	14,65€		DA	D 15WDA*	22,60€
2 x	LC	D 18WT	16,95€	2-6 x	1-10 PU	D 40WP*	44,65€
					1-10 PU DA	D 40WDA*	46,65€

driver does not fit through cutout hole of fixture
 *110V-230V

For warranty use only Trizo21® supplied LED drivers as mentioned.
 For all specs and techs about drivers, see www.trizo21.com/drivers

AUSTERE-SOLITAIRE RLC (for concrete ceiling)

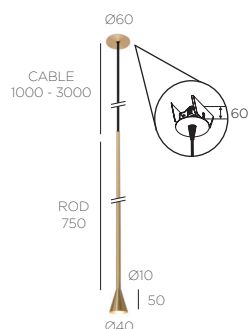

L 1000	HVCC 3013	HVCC 3012	HVCC 3011	390€
L 2000	HVCC 3023	HVCC 3022	HVCC 3021	400€
L 3000	HVCC 3033	HVCC 3032	HVCC 3031	410€
L 1000			HVCC 3014	470€
L 2000			HVCC 3024	480€
L 3000			HVCC 3034	490€

RL = long vertical rod of 750mm + powercord - Other cable lengths available on demand.
 350mA - **driver required (remote mounting) see below**
 1 x LED array 6,2W - 350mA - 630lm - 2700K - CRI >98 - **dimnable**
 aperture : Ø 45 - depth : min. 60 mm - depth for driver in ceiling : min. 110 mm
LED included - Suspension -

REQUIRED DRIVER (REMOTE MOUNTING)

DEVICE	DIM.	DRIVER	NET PRICE	DEVICE	DIM.	DRIVER	NET PRICE
1 x	NO	N 6W	11,20€	1-2 x	1-10 PU	D 15WP*	20,65€
	LC	D 10WT	14,65€		DA	D 15WDA*	22,60€
2 x	LC	D 18WT	16,95€	2-6 x	1-10 PU	D 40WP*	44,65€
					1-10 PU DA	D 40WDA*	46,65€

driver does not fit through cutout hole of fixture
 *110V-230V

For warranty use only Trizo21® supplied LED drivers as mentioned.
 For all specs and techs about drivers, see www.trizo21.com/drivers

AUSTERE-SOLITAIRE RL D+B

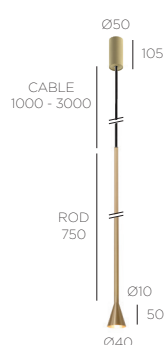

NO	L 1000	HVCBD 3113	HVCBD 3112	HVCBD 3111	585€
NO	L 2000	HVCBD 3123	HVCBD 3122	HVCBD 3121	595€
NO	L 3000	HVCBD 3133	HVCBD 3132	HVCBD 3131	605€
LC	L 1000	HVCBD 3313	HVCBD 3312	HVCBD 3311	595€
LC	L 2000	HVCBD 3323	HVCBD 3322	HVCBD 3321	605€
LC	L 3000	HVCBD 3333	HVCBD 3332	HVCBD 3331	615€

RL = long vertical rod of 750mm + powercord - Other cable lengths available on demand.
 *110V-230V - **driver included in base - non-dimmable**
 230V - **driver included in base - TRIAC/IGBT dimmable**
 1 x LED array 6,2W - 350mA - 630lm - 2700K - CRI >98
LED included - Suspension -

DESIGN YOUR OWN AUSTERE-SUSPENSION - REMOTE MOUNTING

- I. Choose 1 x the CENTER length: 500 mm or 750 mm
- II. Choose 2 x the same END lengths: 250 mm or 500 mm
- III. Choose 4 x the same SIDE lengths: 250 mm or 500 mm

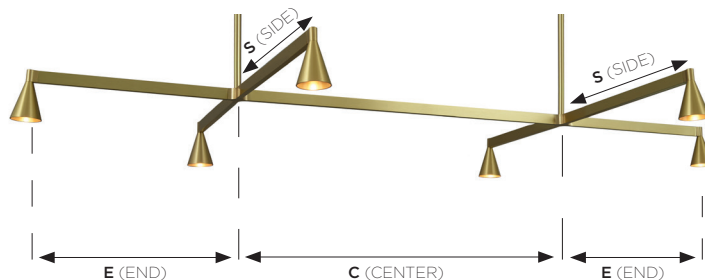

DIMENSIONS:

C 500 mm + 2 x E 250 mm + 4 x S 250 mm	Total size L: 1120 mm W: 590 mm
C 500 mm + 2 x E 250 mm + 4 x S 500 mm	Total size L: 1120 mm W: 1090 mm
C 500 mm + 2 x E 500 mm + 4 x S 250 mm	Total size L: 1620 mm W: 590 mm
C 500 mm + 2 x E 500 mm + 4 x S 500 mm	Total size L: 1620 mm W: 1090 mm
C 750 mm + 2 x E 250 mm + 4 x S 250 mm	Total size L: 1370 mm W: 590 mm
C 750 mm + 2 x E 250 mm + 4 x S 500 mm	Total size L: 1370 mm W: 1090 mm
C 750 mm + 2 x E 500 mm + 4 x S 250 mm	Total size L: 1870 mm W: 590 mm
C 750 mm + 2 x E 500 mm + 4 x S 500 mm	Total size L: 1870 mm W: 1090 mm

IV. Choose the colors and the vertical ROD: RS 16, RL 79, RF 75 or RF 100

<p>rod: RS 16</p> <p>CABLE +/-2000 ROD 160</p> <p>● ○ FRAME ● ○ POWERCORD</p>	<p>rod: RL 79</p> <p>CABLE +/-2000 ROD 790</p> <p>● ○ FRAME ● ○ POWERCORD</p>	<p>rod: RF 75</p> <p>*ROD 750</p> <p>● ○ FRAME</p>	<p>rod: RF 100</p> <p>*ROD 1000</p> <p>● ○ FRAME</p>
		<p>*Total height depends on the chosen mounting option, SEE ! NOTE on product page.</p> <p>Shorter rod available on demand with additional cost.</p>	<p>*Total height depends on the chosen mounting option, SEE ! NOTE on product page.</p> <p>Shorter rod available on demand with additional cost.</p>

V. Choose your cover or canopy for 'remote mounting' driver:

<p>cover C6</p> <p>aperture: Ø45</p> <p>For false ceiling: RS 16, RL 79, RF 75 & RF 100 For concrete ceiling: RS 16 & RL 79</p>	<p>cover C8</p> <p>aperture: Ø30 D50</p> <p>For RF 75 & RF 100</p>	<p>canopy B10</p> <p>For RS 16, RL 79, RF 75 & RF 100</p>	<p>canopy B11</p> <p>For RS 16 & RL 79</p>
---	--	---	--

VI. Choose your 'remote mounting' driver:

driver: non-dimmable

driver: 1-10V dimmable
driver: PUSH-DIM dimmable
driver: DALI dimmable

DESIGN YOUR OWN AUSTERE-SUSPENSION - SURFACE MOUNTING

- I. Choose 1 x the CENTER length: 500 mm or 750 mm
- II. Choose 2 x the same END lengths: 250 mm or 500 mm
- III. Choose 4 x the same SIDE lengths: 250 mm or 500 mm

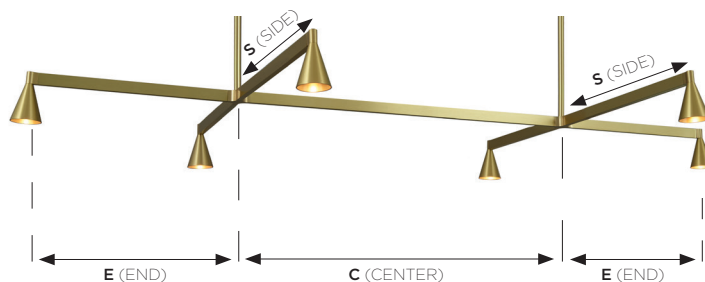

DIMENSIONS:

C 500 mm + 2 x E 250 mm + 4 x S 250 mm	Total size L: 1120 mm W: 590 mm
C 500 mm + 2 x E 250 mm + 4 x S 500 mm	Total size L: 1120 mm W: 1090 mm
C 500 mm + 2 x E 500 mm + 4 x S 250 mm	Total size L: 1620 mm W: 590 mm
C 500 mm + 2 x E 500 mm + 4 x S 500 mm	Total size L: 1620 mm W: 1090 mm
C 750 mm + 2 x E 250 mm + 4 x S 250 mm	Total size L: 1370 mm W: 590 mm
C 750 mm + 2 x E 250 mm + 4 x S 500 mm	Total size L: 1370 mm W: 1090 mm
C 750 mm + 2 x E 500 mm + 4 x S 250 mm	Total size L: 1870 mm W: 590 mm
C 750 mm + 2 x E 500 mm + 4 x S 500 mm	Total size L: 1870 mm W: 1090 mm

- IV. Choose the colors and the vertical ROD: RS 16 or RL 79

rod: **RS 16**

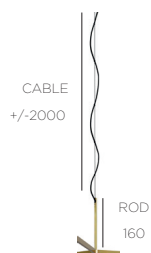

- ○ FRAME
- ○ POWERCORD

rod: **RL 79**

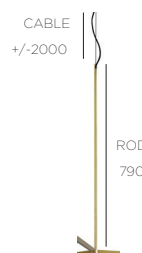

- ○ FRAME
- ○ POWERCORD

- V. Choose your base (driver incl.) for 'surface mounting':



base B20

- ○

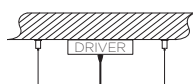

dimnable driver incl. in base
 (1-10V / PUSH-DIM / DALI)
 + casambi possible

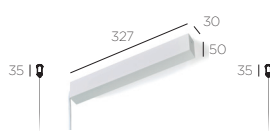

base B32

- ○

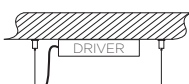

non-dimnable driver incl. in base

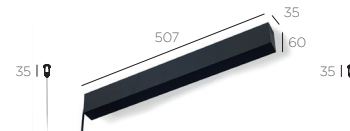

base B50

- ○



dimnable driver incl. in base
 (1-10V / PUSH-DIM / DALI)
 + casambi possible

CENTER LENGTH

END LENGTH

SIDE LENGTH

FRAME

FRAME

RETAIL PRICE
VAT. EXCL.

REMOTE MOUNTING

AUSTERE-SUSPENSION 1+ RF 75 new

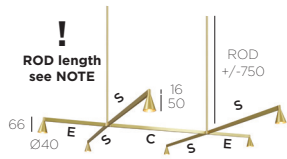

1x 500mm	2x 250mm	4x 250mm
1x 500mm	2x 250mm	4x 500mm
1x 500mm	2x 500mm	4x 250mm
1x 500mm	2x 500mm	4x 500mm
1x 750mm	2x 250mm	4x 250mm
1x 750mm	2x 250mm	4x 500mm
1x 750mm	2x 500mm	4x 250mm
1x 750mm	2x 500mm	4x 500mm

1+ SU RF7 52223	1+ SU RF7 52222	2.429€
1+ SU RF7 52523	1+ SU RF7 52522	2.469€
1+ SU RF7 55223	1+ SU RF7 55222	2.449€
1+ SU RF7 55523	1+ SU RF7 55522	2.489€
1+ SU RF7 72223	1+ SU RF7 72222	2.440€
1+ SU RF7 72523	1+ SU RF7 72522	2.480€
1+ SU RF7 75223	1+ SU RF7 75222	2.460€
1+ SU RF7 75523	1+ SU RF7 75522	2.500€

AUSTERE-SUSPENSION 1+ RF 100

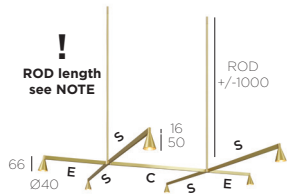

1x 500mm	2x 250mm	4x 250mm
1x 500mm	2x 250mm	4x 500mm
1x 500mm	2x 500mm	4x 250mm
1x 500mm	2x 500mm	4x 500mm
1x 750mm	2x 250mm	4x 250mm
1x 750mm	2x 250mm	4x 500mm
1x 750mm	2x 500mm	4x 250mm
1x 750mm	2x 500mm	4x 500mm

1+ SU RF10 52223	1+ SU RF10 52222	2.449€
1+ SU RF10 52523	1+ SU RF10 52522	2.489€
1+ SU RF10 55223	1+ SU RF10 55222	2.469€
1+ SU RF10 55523	1+ SU RF10 55522	2.509€
1+ SU RF10 72223	1+ SU RF10 72222	2.460€
1+ SU RF10 72523	1+ SU RF10 72522	2.500€
1+ SU RF10 75223	1+ SU RF10 75222	2.480€
1+ SU RF10 75523	1+ SU RF10 75522	2.520€

Shorter RF ROD available in other lengths on demand & with additional cost.

350mA - driver + cover/canopy required* see below

6 x LED array 6,2W - 350mA - 6 x 630lm - 2700K - CRI >98 - dimmable

C (CENTER LENGTH), E (END LENGTH), S (SIDE LENGTH), total dimensions see p. 67

LED included - Suspension - IP50 eco

*REQUIRED FOR REMOTE MOUNTING: COVER/CANOPY



cover C6

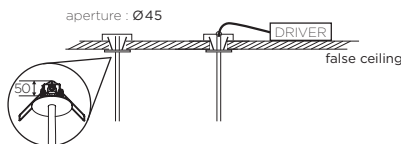

22CO 3300	136€
22CO 2200	136€
22CO 1100	136€

NOTE: cover C6 + rod RF 75 :
If the thickness of the false ceiling is 15mm, the total length of the chandelier RF 75 with cover C6 will be 778mm.

NOTE: cover C6 + rod RF 100 :
If the thickness of the false ceiling is 15mm, the total length of the chandelier RF 100 with cover C6 will be 1028mm.



cover C8

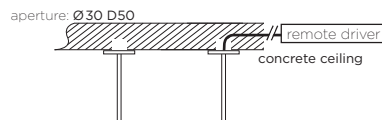

22CO 8003	160€
22CO 8002	160€
22CO 8001	160€

NOTE: cover C8 + rod RF 75 :
the total length of the chandelier RF 75 with cover C8 will be 806mm.

NOTE: cover C8 + rod RF 100 :
the total length of the chandelier RF 100 with cover C8 will be 1056mm.



canopy B10

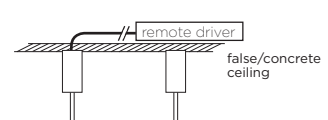

22CP 3333	444€
22CP 2222	444€
22CP 1111	444€

NOTE: canopy B10 + rod RF 75 :
the total length of the chandelier RF 75 with canopy B10 will be 906mm.

NOTE: canopy B10 + rod RF 100 :
the total length of the chandelier RF 100 with canopy B10 will be 1156mm.

*REQUIRED FOR REMOTE MOUNTING: DRIVER

DEVICE	DIM.	DRIVER	NET PRICE	DEVICE	DIM.	DRIVER	NET PRICE
1 x	I	NO	23€	1 x	I-10	PU	37€
		I			DA	PU	42€

* driver only fits through cutout hole of fixture with C6, min. depth for driver in false ceiling: 280mm

For warranty use only Trizo21® supplied LED drivers as mentioned. For all specs and techs about drivers, see www.trizo21.com/drivers

CENTER LENGTH	END LENGTH	SIDE LENGTH	FRAME	POWERCORD	STEELCABLE	FRAME	POWERCORD	STEELCABLE	FRAME	POWERCORD	STEELCABLE	FRAME	POWERCORD	STEELCABLE	RETAIL PRICE VAT. EXCL.
			●	●	●	●	●	●	●	○	○	○	○	○	

REMOTE MOUNTING

AUSTERE-SUSPENSION 1+ RS 16



1x 500mm	2x 250mm	4x 250mm	1+ SU RS 52223	1+ SU RS 52222	1+ SU RS 52213	1+ SU RS 52212	2.389€
1x 500mm	2x 250mm	4x 500mm	1+ SU RS 52523	1+ SU RS 52522	1+ SU RS 52513	1+ SU RS 52512	2.429€
1x 500mm	2x 500mm	4x 250mm	1+ SU RS 55223	1+ SU RS 55222	1+ SU RS 55213	1+ SU RS 55212	2.409€
1x 500mm	2x 500mm	4x 500mm	1+ SU RS 55523	1+ SU RS 55522	1+ SU RS 55513	1+ SU RS 55512	2.449€
1x 750mm	2x 250mm	4x 250mm	1+ SU RS 72223	1+ SU RS 72222	1+ SU RS 72213	1+ SU RS 72212	2.400€
1x 750mm	2x 250mm	4x 500mm	1+ SU RS 72523	1+ SU RS 72522	1+ SU RS 72513	1+ SU RS 72512	2.440€
1x 750mm	2x 500mm	4x 250mm	1+ SU RS 75223	1+ SU RS 75222	1+ SU RS 75213	1+ SU RS 75212	2.420€
1x 750mm	2x 500mm	4x 500mm	1+ SU RS 75523	1+ SU RS 75522	1+ SU RS 75513	1+ SU RS 75512	2.460€

AUSTERE-SUSPENSION 1+ RL 79



1x 500mm	2x 250mm	4x 250mm	1+ SU RL 52223	1+ SU RL 52222	1+ SU RL 52213	1+ SU RL 52212	2.449€
1x 500mm	2x 250mm	4x 500mm	1+ SU RL 52523	1+ SU RL 52522	1+ SU RL 52513	1+ SU RL 52512	2.489€
1x 500mm	2x 500mm	4x 250mm	1+ SU RL 55223	1+ SU RL 55222	1+ SU RL 55213	1+ SU RL 55212	2.469€
1x 500mm	2x 500mm	4x 500mm	1+ SU RL 55523	1+ SU RL 55522	1+ SU RL 55513	1+ SU RL 55512	2.509€
1x 750mm	2x 250mm	4x 250mm	1+ SU RL 72223	1+ SU RL 72222	1+ SU RL 72213	1+ SU RL 72212	2.460€
1x 750mm	2x 250mm	4x 500mm	1+ SU RL 72523	1+ SU RL 72522	1+ SU RL 72513	1+ SU RL 72512	2.500€
1x 750mm	2x 500mm	4x 250mm	1+ SU RL 75223	1+ SU RL 75222	1+ SU RL 75213	1+ SU RL 75212	2.480€
1x 750mm	2x 500mm	4x 500mm	1+ SU RL 75523	1+ SU RL 75522	1+ SU RL 75513	1+ SU RL 75512	2.520€

350mA - driver + cover/canopy required* see below

6 x LED array 6,2W - 350mA - 6 x 630lm - 2700K - CRI >98 - dimmable

C (CENTER LENGTH), E (END LENGTH), S (SIDE LENGTH), total dimensions see p. 67

LED included - Suspension -

*REQUIRED FOR REMOTE MOUNTING: COVER/CANOPY

cover C6	cover C6	canopy B10																											
aperture: Ø45 false ceiling	aperture: Ø45 concrete ceiling	remote driver false/concrete ceiling																											
<table border="0"> <tr><td>●</td><td>21CO 0003</td><td>68€</td></tr> <tr><td>●</td><td>21CO 0002</td><td>68€</td></tr> <tr><td>○</td><td>21CO 0001</td><td>68€</td></tr> </table>	●	21CO 0003	68€	●	21CO 0002	68€	○	21CO 0001	68€	<table border="0"> <tr><td>●</td><td>21CO 0013</td><td>84€</td></tr> <tr><td>●</td><td>21CO 0012</td><td>84€</td></tr> <tr><td>●</td><td>21CO 0011</td><td>84€</td></tr> </table>	●	21CO 0013	84€	●	21CO 0012	84€	●	21CO 0011	84€	<table border="0"> <tr><td>●</td><td>21CP 3003</td><td>222€</td></tr> <tr><td>●</td><td>21CP 2002</td><td>222€</td></tr> <tr><td>●</td><td>21CP 1001</td><td>222€</td></tr> </table>	●	21CP 3003	222€	●	21CP 2002	222€	●	21CP 1001	222€
●	21CO 0003	68€																											
●	21CO 0002	68€																											
○	21CO 0001	68€																											
●	21CO 0013	84€																											
●	21CO 0012	84€																											
●	21CO 0011	84€																											
●	21CP 3003	222€																											
●	21CP 2002	222€																											
●	21CP 1001	222€																											

*REQUIRED FOR REMOTE MOUNTING: DRIVER

DEVICE	DIM.	DRIVER	NET PRICE	DEVICE	DIM.	DRIVER	NET PRICE
1 x	NO	N 50W*	24€	1 x	I-10 DA	D 80WP*	37€
					PU	D 80WD*	42€

*driver only fits through cutout hole of fixture with C6.
min. depth for driver in false ceiling: 280mm

For warranty use only Trizo21® supplied LED drivers as mentioned.
For all specs and techs about drivers, see www.trizo21.com/drivers

CENTER LENGTH

END LENGTH

SIDE LENGTH

FRAME
POWERCORD
STEELCABLE

FRAME
POWERCORD
STEELCABLE

FRAME
POWERCORD
STEELCABLE

FRAME
POWERCORD
STEELCABLE

RETAIL PRICE
VAT. EXCL.



SURFACE MOUNTING

AUSTERE-SUSPENSION 1+ RS 16

1x 500mm	2x 250mm	4x 250mm	1+ SU RS 52223	1+ SU RS 52222	1+ SU RS 52213	1+ SU RS 52212	2.389€
1x 500mm	2x 250mm	4x 500mm	1+ SU RS 52523	1+ SU RS 52522	1+ SU RS 52513	1+ SU RS 52512	2.429€
1x 500mm	2x 500mm	4x 250mm	1+ SU RS 55223	1+ SU RS 55222	1+ SU RS 55213	1+ SU RS 55212	2.409€
1x 500mm	2x 500mm	4x 500mm	1+ SU RS 55523	1+ SU RS 55522	1+ SU RS 55513	1+ SU RS 55512	2.449€
1x 750mm	2x 250mm	4x 250mm	1+ SU RS 72223	1+ SU RS 72222	1+ SU RS 72213	1+ SU RS 72212	2.400€
1x 750mm	2x 250mm	4x 500mm	1+ SU RS 72523	1+ SU RS 72522	1+ SU RS 72513	1+ SU RS 72512	2.440€
1x 750mm	2x 500mm	4x 250mm	1+ SU RS 75223	1+ SU RS 75222	1+ SU RS 75213	1+ SU RS 75212	2.420€
1x 750mm	2x 500mm	4x 500mm	1+ SU RS 75523	1+ SU RS 75522	1+ SU RS 75513	1+ SU RS 75512	2.460€

AUSTERE-SUSPENSION 1+ RL 79

1x 500mm	2x 250mm	4x 250mm	1+ SU RL 52223	1+ SU RL 52222	1+ SU RL 52213	1+ SU RL 52212	2.449€
1x 500mm	2x 250mm	4x 500mm	1+ SU RL 52523	1+ SU RL 52522	1+ SU RL 52513	1+ SU RL 52512	2.489€
1x 500mm	2x 500mm	4x 250mm	1+ SU RL 55223	1+ SU RL 55222	1+ SU RL 55213	1+ SU RL 55212	2.469€
1x 500mm	2x 500mm	4x 500mm	1+ SU RL 55523	1+ SU RL 55522	1+ SU RL 55513	1+ SU RL 55512	2.509€
1x 750mm	2x 250mm	4x 250mm	1+ SU RL 72223	1+ SU RL 72222	1+ SU RL 72213	1+ SU RL 72212	2.460€
1x 750mm	2x 250mm	4x 500mm	1+ SU RL 72523	1+ SU RL 72522	1+ SU RL 72513	1+ SU RL 72512	2.500€
1x 750mm	2x 500mm	4x 250mm	1+ SU RL 75223	1+ SU RL 75222	1+ SU RL 75213	1+ SU RL 75212	2.480€
1x 750mm	2x 500mm	4x 500mm	1+ SU RL 75523	1+ SU RL 75522	1+ SU RL 75513	1+ SU RL 75512	2.520€

350mA - driver + base required* see below

6 x LED array 6,2W - 350mA - 6 x 630lm - 2700K - CRI >98 - dimmable

C (CENTER LENGTH), E (END LENGTH), S (SIDE LENGTH), total dimensions see p. 68

LED included - Suspension - CE IP50 eco

*REQUIRED FOR SURFACE MOUNTING: BASE (DRIVER INCL.)



base B20

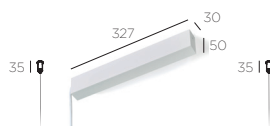
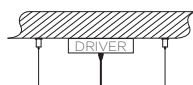

base B32

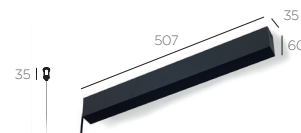
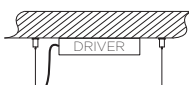

base B50



●	1-10 PU	BCPU 2402	255€
○	1-10 PU	BCPU 2401	255€
●	DA PU	BCDA 2402	255€
○	DA PU	BCDA 2401	255€

110V-230V - driver included in base
+ casambi possible

NO	BNDN 0822	365€
NO	BNDN 0811	365€

230V - driver included in base

1-10 PU	BDPU 0822	445€
1-10 PU	BDPU 0811	445€
DA PU	BDDA 0822	470€
DA PU	BDDA 0811	470€

230V - driver included in base
+ casambi possible

I-TRO

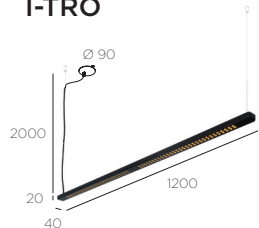

DIM.	FRAME	FRAME	RETAIL PRICE VAT. EXCL.
1 side	●	○	I-TRO 1111 I-TRO 2211 938€
2 sides	●	○	I-TRO 1122 I-TRO 2222 1.373€

24Vdc - **driver required (remote mounting)** see below

1 lighting side : 120 x SMD LED 30W - 24Vdc - 2280lm - 2850K - CRI >90 - **dimnable**
 2 lighting sides : 240 x SMD LED 60W - 24Vdc - 4560lm - 2850K - CRI >90 - **dimnable**
 depth for driver in ceiling : min. 120 mm

LED included - Suspension -

REQUIRED DRIVER (REMOTE MOUNTING)

DEVICE	DIM.	DRIVER	NET PRICE	DEVICE	DIM.	DRIVER	NET PRICE
1 x 1 side	1-10	D 40W10*	38,10€	2 x 1 side	1-10	D 60W10*	48,75€
1 x 2 sides	1-10	D 60W10*	48,75€				

*110V-230V

For warranty use only Trizo21® supplied LED drivers as mentioned.
For all specs and techs about drivers, see www.trizo21.com/drivers

I-TRO D+B

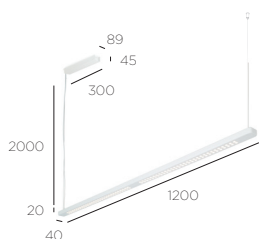

1 side	1-10	I-TRO 1101	I-TRO 2201	1.105€
2 sides	1-10	I-TRO 1102	I-TRO 2202	1.551€

100V-240V - **driver included in base** - 1-10V dimmable

1 lighting side : 120 x SMD LED 30W - 24Vdc - 2280lm - 2850K - CRI >90
 2 lighting sides : 240 x SMD LED 60W - 24Vdc - 4560lm - 2850K - CRI >90

LED included - Suspension -

LIPPS 200 SU







DIM.	FRAME	INTERIOR	FRAME	INTERIOR	FRAME	INTERIOR	FRAME	INTERIOR	FRAME	INTERIOR	FRAME	INTERIOR	RETAIL PRICE VAT. EXCL.
LC	●	○	●	○	●	○	○	○	○	○	○	○	465€
PU	●	○	●	○	○	○	○	○	○	○	○	○	465€
DA	●	○	●	○	○	○	○	○	○	○	○	○	480€

110V-230V - **driver included in base** - TRIAC/IGBT, 1-10V, PUSH-DIM or DALI dimmable

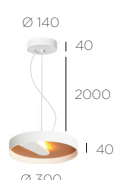
LED array 6W - 700mA - 1 x 500lm - 2700K - CRI >90

LED included - Suspension -



DIM	FRAME		INTERIOR		FRAME		INTERIOR		FRAME		INTERIOR		FRAME		INTERIOR		RETAIL PRICE VAT. EXCL.
	●	○	●	○	●	○	○	○	○	○	○	○	○	○	○		
 <p>∅ 140 40 2000 ∅ 300</p>	LC	LISU 3327	LISU 3328	LISU 3321	LISU 3317	LISU 3318	LISU 3311	585€									
	PU	LISU 3027	LISU 3028	LISU 3021	LISU 3017	LISU 3018	LISU 3011	585€									
	DA	LISU 3527	LISU 3528	LISU 3521	LISU 3517	LISU 3518	LISU 3511	600€									

110V-230V - driver included in base - TRIAC/IGBT, 1-10V, PUSH-DIM or DALI dimmable
 LED array 9W - 350mA - 3 x 250lm - 2700K - CRI >90
LED included - Suspension -   

LIPPS 600 SU





 <p>∅ 199 40 2000 ∅ 600</p>	LC	LISU 6627	LISU 6628	LISU 6621	LISU 6617	LISU 6618	LISU 6611	1.060€
	PU	LISU 6027	LISU 6028	LISU 6021	LISU 6017	LISU 6018	LISU 6011	1.060€
	DA	LISU 6527	LISU 6528	LISU 6521	LISU 6517	LISU 6518	LISU 6511	1.075€

110V-230V - driver included in base - TRIAC/IGBT, 1-10V, PUSH-DIM or DALI dimmable
 LED array 36W - 500mA - 8 x 375lm - 2700K - CRI >90
LED included - Suspension -   

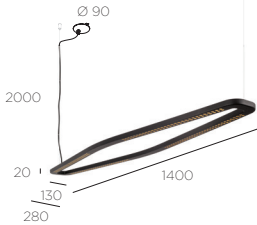
N-TRO



DIM.	FRAME	FRAME	RETAIL PRICE VAT. EXCL.
	●	○	
	NTRO 1111	NTRO 2222	1.983€

24Vdc - driver required (remote mounting) see below
 240 x SMD LED 60W - 24Vdc - 4560lm - 2850K - CRI >90 - dimmable
 depth for driver in ceiling : min. 120 mm
LED included - Suspension -   

REQUIRED DRIVER (REMOTE MOUNTING)

DEVICE	DIM.	DRIVER	NET PRICE
1 X	1-10	D 60W10*	48,75€



*110V-230V

For warranty use only Trizo21® supplied LED drivers as mentioned.
 For all specs and techs about drivers, see www.trizo21.com/drivers

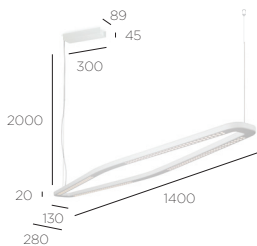
N-TRO D+B



1-10	NTRO 1000	NTRO 2000	2.261€
------	-----------	-----------	--------

100V-240V - driver included in base - 1-10V dimmable
 240 x SMD LED 60W - 24Vdc - 4560lm - 2850K - CRI >90
LED included - Suspension -   

SIRENS SU diffuser glass



	FRAME	FRAME	FRAME	RETAIL PRICE VAT. EXCL.
	●	○	●	
Ø 210	SISU 2112	SISU 2111		356€
Ø 265	SISU 2612	SISU 2611		418€
Ø 210			SISU 2117	387€
Ø 265			SISU 2617	448€

110V-230V

E27 - only energy saving bulbs (LED or FLUO)

LED or FLUO bulb excluded - Suspension -

SIRENS SU mirror

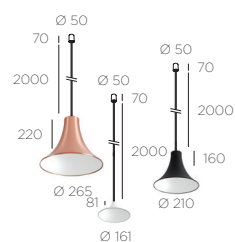

Ø 161	SISU 1602	SISU 1601		196€
Ø 210	SISU 2102	SISU 2101		278€
Ø 265	SISU 2602	SISU 2601		325€
Ø 161			SISU 1607	227€
Ø 210			SISU 2107	309€
Ø 265			SISU 2607	356€

Suspension

SIRENS SU frosted glass big mirror + edge mirror

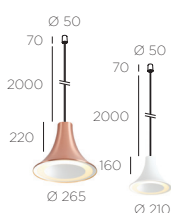

Ø 210	SISU 2122	SISU 2121		335€
Ø 265	SISU 2622	SISU 2621		381€
Ø 210			SISU 2127	366€
Ø 265			SISU 2627	412€

110V-230V

E27 - only energy saving bulbs (LED or FLUO)

LED or FLUO bulb excluded - Suspension -

SIRENS SU frosted glass small mirror + edge mirror

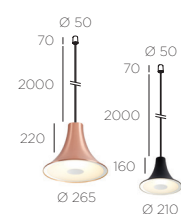

Ø 210	SISU 2132	SISU 2131		335€
Ø 265	SISU 2632	SISU 2631		381€
Ø 210			SISU 2137	366€
Ø 265			SISU 2637	412€

110V-230V

E27 - only energy saving bulbs (LED or FLUO)

LED or FLUO bulb excluded - Suspension -

SIRENS SU frosted glass edge mirror

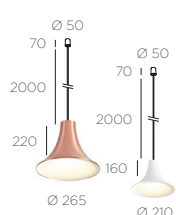

Ø 210	SISU 2142	SISU 2141		335€
Ø 265	SISU 2642	SISU 2641		381€
Ø 210			SISU 2147	366€
Ø 265			SISU 2647	412€

110V-230V

E27 - only energy saving bulbs (LED or FLUO)

LED or FLUO bulb excluded - Suspension -

Recessed



2THIRTY-IN

2THIRTY-IN C1	84
2THIRTY-IN C1 350mA	84
2THIRTY-IN C2	85
2THIRTY-IN C2 350mA	86
2THIRTY-IN W1	86
2THIRTY-IN W1 350mA	87



AUST-IN

AUST-IN	88
AUST-IN ADJUSTABLE	89



BOULY

BOULY 4	90
BOULY 16	90



MINI-PI IN

MINI-PI 1 IN	91
MINI-PI 2 IN	92



PIN-IN

PIN-IN 1	92
PIN-IN 2	92



R5 IN

R51 IN GU5.3	93
R51 RIMLESS GU5.3	93
R52 IN GU5.3	94
R52 RIMLESS GU5.3	94
R54 IN GU5.3	95
R54 RIMLESS GU5.3	95
R51 IN GU10	96
R52 IN GU10	96
R54 IN GU10	97
R51 IN LED	98
R51 RIMLESS LED	98
R52 IN LED	99
R52 RIMLESS LED	99
R54 IN LED	100
R54 RIMLESS LED	100



R07 / R70 IN

R07 IN	101
R07 RIMLESS	101
R70 IN	102
R70 RIMLESS	102



R110 / R111 IN

R110 IN G53	103
R110 RIMLESS	103
R111 IN G53	104
R111 RIMLESS	104

RING	ROD	FRAME	SWIVEL	RETAIL PRICE VAT. EXCL.
	●	●	●	

2Thirty-In C1



●	THIN 12223◆	375€
●	THIN 17223◆	375€
●	THIN 18223◆	375€

230V (110V on demand)
 1 x LED module 10W - 230V - 1000lm - 2700K - CRI >90 - **dimmable**
 aperture : Ø 45 - depth : min. 40 mm
 ◆ Choose beam: N=narrow 12° or M=medium 24° or W=wide 40°
 Optional ring with honeycomb: see below
LED included - Ceiling -

OPTIONAL RING + HONEYCOMB FOR 2THIRTY



●	TH 200RH	35€
●	TH 700RH	35€
●	TH 800RH	35€

2Thirty-In C1 + honeycomb



●	THIN 12223H◆	395€
●	THIN 17223H◆	395€
●	THIN 18223H◆	395€

230V (110V on demand)
 1 x LED module 10W - 230V - 1000lm - 2700K - CRI >90 - **dimmable**
 aperture : Ø 45 - depth : min. 40 mm
 ◆ Choose beam: N=narrow 12° or M=medium 24° or W=wide 40°
 Optional ring without honeycomb: see below
LED included - Ceiling -

OPTIONAL RING FOR 2THIRTY



●	TH 200R	23€
●	TH 700R	23€
●	TH 800R	23€

2Thirty-In C1 350mA

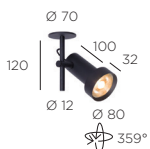

●	TH3N 12223◆	295€
●	TH3N 17223◆	295€
●	TH3N 18223◆	295€

350mA - **driver required (remote mounting)** see below
 1 x LED array 11,8W - 350mA - 1241lm - 2700K - CRI >97 - **dimmable**
 aperture : Ø 45 - depth : min. 40 mm
 ◆ Choose beam: N=narrow 12° or M=medium 24° or W=wide 40°
 Optional ring with honeycomb: see below
LED included - Ceiling -

REQUIRED DRIVER (REMOTE MOUNTING)

DEVICE	DIM.	DRIVER	NET PRICE	DEVICE	DIM.	DRIVER	NET PRICE
1 x	LC	D 18WT	16,95€	1-3 x	1-10 PU DA	D 40WDP*	46,65€
	DA PU	D 15WP*	20,65€				
	DA	D 15WDA*	22,60€				

driver does not fit through cutout hole of fixture
 *110V-230V

**For warranty use only Trizo21® supplied LED drivers as mentioned.
 For all specs and techs about drivers, see www.trizo21.com/drivers**

OPTIONAL RING + HONEYCOMB FOR 2THIRTY



●	TH 200RH	35€
●	TH 700RH	35€
●	TH 800RH	35€

RING	ROD	FRAME	SWIVEL	RETAIL PRICE VAT: EXCL.
	●	●	●	

2Thirty-In C1 350mA + honeycomb



●	TH3N 12223H	315€
●	TH3N 17223H	315€
●	TH3N 18223H	315€

350mA - **driver required (remote mounting)** see below
 1 x LED array 11,8W - 350mA - 1241lm - 2700K - CRI >97 - **dimmable**
 aperture : Ø 45 - depth : min. 40 mm

◆ Choose beam: N=narrow 12° or M=medium 24° or W=wide 40°
 Optional ring without honeycomb: see below
LED included - Ceiling -

REQUIRED DRIVER (REMOTE MOUNTING)

DEVICE	DIM.	DRIVER	NET PRICE	DEVICE	DIM.	DRIVER	NET PRICE
1 x	LC	D 18WT	16,95€	1-3 x	1-10 PU DA	D 40WDP*	46,65€
	DA PU	D 15WP*	20,65€				
	DA	D 15WDA*	22,60€				

driver does not fit through cutout hole of fixture
 *110V-230V

**For warranty use only Trizo21® supplied LED drivers as mentioned.
 For all specs and techs about drivers, see www.trizo21.com/drivers**

OPTIONAL RING FOR 2THIRTY



●	TH 200R	23€
●	TH 700R	23€
●	TH 800R	23€

2Thirty-In C2

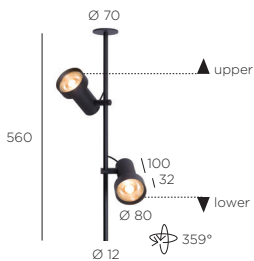

●	THIN 22223 ▲▼	660€
●	THIN 27223 ▲▼	660€
●	THIN 28223 ▲▼	660€

230V (110V on demand)
 2 x LED module 10W - 230V - 2 x 1000lm - 2700K - CRI >90 - **dimmable**
 aperture : Ø 45 - depth : min. 40 mm

▲ = Choose beam upper lightsource: N=narrow 12° or M=medium 24° or W=wide 40°
 ▼ = Choose beam lower lightsource: N=narrow 12° or M=medium 24° or W=wide 40°
 Optional ring with honeycomb: see below
LED included - Ceiling -

OPTIONAL RING + HONEYCOMB FOR 2THIRTY



●	TH 200RH	35€
●	TH 700RH	35€
●	TH 800RH	35€

2Thirty-In C2 + honeycomb

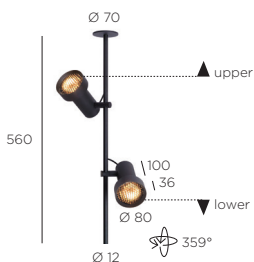

●	THIN 22223H ▲▼	700€
●	THIN 27223H ▲▼	700€
●	THIN 28223H ▲▼	700€

230V (110V on demand)
 2 x LED module 10W - 230V - 2 x 1000lm - 2700K - CRI >90 - **dimmable**
 aperture : Ø 45 - depth : min. 40 mm

▲ = Choose beam upper lightsource: N=narrow 12° or M=medium 24° or W=wide 40°
 ▼ = Choose beam lower lightsource: N=narrow 12° or M=medium 24° or W=wide 40°
 Optional ring without honeycomb: see below
LED included - Ceiling -

OPTIONAL RING FOR 2THIRTY



●	TH 200R	23€
●	TH 700R	23€
●	TH 800R	23€

RING	ROD	FRAME	SWIVEL	RETAIL PRICE VAT. EXCL.
	●	●	●	

2Thirty-In C2 350mA

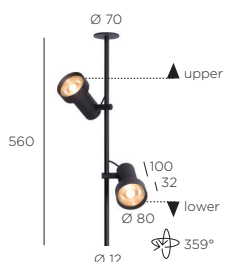

●	TH3N 22223 ▲▼	570€
●	TH3N 27223 ▲▼	570€
●	TH3N 28223 ▲▼	570€

350mA - **driver required (remote mounting)** see below
 2 x LED array 11,8W - 350mA - 2 x 1241lm - 2700K - CRI >97 - **dimmable**
 aperture : Ø 45 - depth : min. 40 mm

▲ = Choose beam upper lightsource: N=narrow 12° or M=medium 24° or W=wide 40°
 ▼ = Choose beam lower lightsource: N=narrow 12° or M=medium 24° or W=wide 40°

Optional ring with honeycomb: see below
LED included - Ceiling -

REQUIRED DRIVER (REMOTE MOUNTING)

DEVICE	DIM.	DRIVER	NET PRICE
1 x	1-10 PU DA	D 40WDP*	46,65

driver does not fit through cutout hole of fixture
*110V-230V

For warranty use only Trizo21® supplied LED drivers as mentioned.
 For all specs and techs about drivers, see www.trizo21.com/drivers

OPTIONAL RING + HONEYCOMB FOR 2THIRTY



●	TH 200RH	35€
●	TH 700RH	35€
●	TH 800RH	35€

2Thirty-In C2 350mA + honeycomb

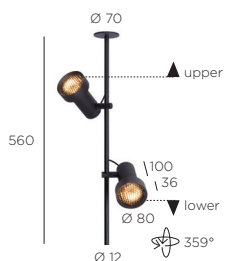

●	TH3N 22223H ▲▼	610€
●	TH3N 27223H ▲▼	610€
●	TH3N 28223H ▲▼	610€

350mA - **driver required (remote mounting)** see below
 2 x LED array 11,8W - 350mA - 2 x 1241lm - 2700K - CRI >97 - **dimmable**
 aperture : Ø 45 - depth : min. 40 mm

▲ = Choose beam upper lightsource: N=narrow 12° or M=medium 24° or W=wide 40°
 ▼ = Choose beam lower lightsource: N=narrow 12° or M=medium 24° or W=wide 40°

Optional ring without honeycomb: see below
LED included - Ceiling -

REQUIRED DRIVER (REMOTE MOUNTING)

DEVICE	DIM.	DRIVER	NET PRICE
1 x	1-10 PU DA	D 40WDP*	46,65€

driver does not fit through cutout hole of fixture
*110V-230V

For warranty use only Trizo21® supplied LED drivers as mentioned.
 For all specs and techs about drivers, see www.trizo21.com/drivers

OPTIONAL RING FOR 2THIRTY



●	TH 200R	23€
●	TH 700R	23€
●	TH 800R	23€

RING	ROD	FRAME	SWIVEL	RETAIL PRICE VAT. EXCL.
	●	●	●	

2Thirty-In W1



●	TWIN 12223◆	375€
●	TWIN 17223◆	375€
●	TWIN 18223◆	375€

230V (110V on demand) - **ON/OFF on armature**
 1 x LED module 10W - 230V - 1000lm - 2700K - CRI >90 - **dimmable**
 aperture : Ø 45 - depth : min. 40 mm
 ◆ Choose beam: N=narrow 12° or M=medium 24° or W=wide 40°
 Optional ring with honeycomb: see below
LED included - Wall -

OPTIONAL RING + HONEYCOMB FOR 2THIRTY



●	TH 200RH	35€
●	TH 700RH	35€
●	TH 800RH	35€

2Thirty-In W1 + honeycomb



●	TWIN 12223H◆	395€
●	TWIN 17223H◆	395€
●	TWIN 18223H◆	395€

230V (110V on demand) - **ON/OFF on armature**
 1 x LED module 10W - 230V - 1000lm - 2700K - CRI >90 - **dimmable**
 aperture : Ø 45 - depth : min. 40 mm
 ◆ Choose beam: N=narrow 12° or M=medium 24° or W=wide 40°
 Optional ring without honeycomb: see below
LED included - Wall -

OPTIONAL RING FOR 2THIRTY



●	TH 200R	23€
●	TH 700R	23€
●	TH 800R	23€

2Thirty-In W1 350mA



●	TW3N 12223◆	295€
●	TW3N 17223◆	295€
●	TW3N 18223◆	295€

350mA - **driver required (remote mounting) see below** - **ON/OFF on armature**
 1 x LED array 11,8W - 350mA - 1241lm - 2700K - CRI >97 - **dimmable**
 aperture : Ø 45 - depth : min. 40 mm
 ◆ Choose beam: N=narrow 12° or M=medium 24° or W=wide 40°
 Optional ring with honeycomb: see below
LED included - Wall -

REQUIRED DRIVER (REMOTE MOUNTING)

DEVICE	DIM.	DRIVER	NET PRICE	DEVICE	DIM.	DRIVER	NET PRICE
1 x	LC DA PU DA	D 18WT D 15WP* D 15WDA*	16,95€ 20,65€ 22,60€	1-3 x	1-10 PU DA	D 40WDP*	46,65€

driver does not fit through cutout hole of fixture
 *110V-230V

For warranty use only Trizo21® supplied LED drivers as mentioned.
 For all specs and techs about drivers, see www.trizo21.com/drivers

OPTIONAL RING + HONEYCOMB FOR 2THIRTY



●	TH 200RH	35€
●	TH 700RH	35€
●	TH 800RH	35€

2Thirty-In W1 350mA + honeycomb

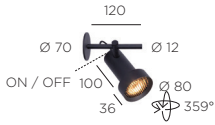

RING	ROD	FRAME	SWIVEL	RETAIL PRICE VAT. EXCL.
●	●	●	●	
●				TW3N 12223H ◆ 315€
●				TW3N 17223H ◆ 315€
●				TW3N 18223H ◆ 315€

350mA - **driver required (remote mounting)** see below - ON/OFF on armature
 1 x LED array 11,8W - 350mA - 1241lm - 2700K - CRI >97 - **dimmable**
 aperture : Ø 45 - depth : min. 40 mm
 ◆ Choose beam: N=narrow 12° or M=medium 24° or W=wide 40°
 Optional ring without honeycomb: see below
LED included - Wall -

REQUIRED DRIVER (REMOTE MOUNTING)							
DEVICE	DIM.	DRIVER	NET PRICE	DEVICE	DIM.	DRIVER	NET PRICE
1 x	LC	D 18WT	16,95€	1-3 x	1-10 PU DA	D 40WDP*	46,65€
	DA PU	D 15WP*	20,65€				
	DA	D 15WDA*	22,60€				

driver does not fit through cutout hole of fixture
 *110V-230V

**For warranty use only Trizo21® supplied LED drivers as mentioned.
 For all specs and techs about drivers, see www.trizo21.com/drivers**

OPTIONAL RING FOR 2THIRTY



●	TH 200R	23€
●	TH 700R	23€
●	TH 800R	23€

AUST-IN (for false ceiling)

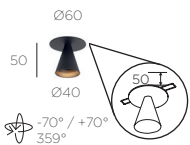

FRAME	FRAME	FRAME	FRAME	RETAIL PRICE VAT. EXCL.
●	●	○	●	
●				AUIN L003 199€
●				AUIN L002 199€
●				AUIN L001 199€
●				AUIN L004 279€

350mA - **driver required (remote mounting)** see below
 1 x LED array 6,2W - 350mA - 630lm - 2700K - CRI >98 - **dimmable**
 aperture : Ø 45 - depth : min. 50 mm - depth for driver in ceiling : min. 70 mm
LED included - Ceiling -

REQUIRED DRIVER (REMOTE MOUNTING)							
DEVICE	DIM.	DRIVER	NET PRICE	DEVICE	DIM.	DRIVER	NET PRICE
1 x	NO	N 6W	11,20€	1-2 x	1-10 PU	D 15WP*	20,65€
	LC	D 10WT	14,65€		DA	D 15WDA*	22,60€
2 x	LC	D 18WT	16,95€	2-6 x	1-10 PU	D 40WP*	44,65€
					DA PU DA	D 40WD*	46,65€

driver does not fit through cutout hole of fixture
 *110V-230V

**For warranty use only Trizo21® supplied LED drivers as mentioned.
 For all specs and techs about drivers, see www.trizo21.com/drivers**

FRAME	FRAME	FRAME	FRAME	RETAIL PRICE VAT. EXCL.
●	●	○	●	

AUST-IN (for concrete ceiling)

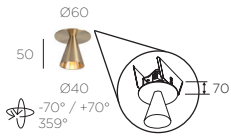

ACIN L003	ACIN L002	ACIN L001	ACIN L004	209€
				289€

350mA - **driver required (remote mounting)** see below
 1 x LED array 6,2W - 350mA - 630lm - 2700K - CRI >98 - **dimmable**
 aperture : Ø 45 - depth : min. 70 mm - depth for driver in ceiling : min. 110 mm
LED included - Ceiling -

REQUIRED DRIVER (REMOTE MOUNTING)							
DEVICE	DIM.	DRIVER	NET PRICE	DEVICE	DIM.	DRIVER	NET PRICE
1 x	NO	N 6W	11,20€	1-2 x	1-10 PU	D 15WP*	20,65€
	LC	D 10WT	14,65€		DA	D 15WDA*	22,60€
2 x	LC	D 18WT	16,95€	2-6 x	1-10 PU	D 40WP*	44,65€
					DA PU DA	D 40WD*	46,65€

driver does not fit through cutout hole of fixture
 *110V-230V

**For warranty use only Trizo21® supplied LED drivers as mentioned.
 For all specs and techs about drivers, see www.trizo21.com/drivers**

AUST-IN ADJUSTABLE (for false ceiling)

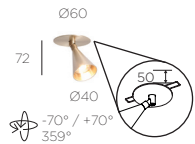

AUAN T003	AUAN T002	AUAN T001	AUAN T004	245€
				325€

350mA - **driver required (remote mounting)** see below
 1 x LED array 6,2W - 350mA - 630lm - 2700K - CRI >98 - **dimmable**
 aperture : Ø 45 - depth : min. 50 mm - depth for driver in ceiling : min. 70 mm
LED included - Wall & ceiling -

REQUIRED DRIVER (REMOTE MOUNTING)							
DEVICE	DIM.	DRIVER	NET PRICE	DEVICE	DIM.	DRIVER	NET PRICE
1 x	NO	N 6W	11,20€	1-2 x	1-10 PU	D 15WP*	20,65€
	LC	D 10WT	14,65€		DA	D 15WDA*	22,60€
2 x	LC	D 18WT	16,95€	2-6 x	1-10 PU	D 40WP*	44,65€
					DA PU DA	D 40WD*	46,65€

driver does not fit through cutout hole of fixture
 *110V-230V

**For warranty use only Trizo21® supplied LED drivers as mentioned.
 For all specs and techs about drivers, see www.trizo21.com/drivers**

AUST-IN ADJUSTABLE (for concrete ceiling)

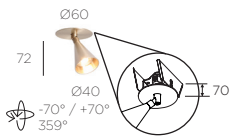

ACAN T003	ACAN T002	ACAN T001	ACAN T004	255€
				335€

350mA - **driver required (remote mounting)** see below
 1 x LED array 6,2W - 350mA - 630lm - 2700K - CRI >98 - **dimmable**
 aperture : Ø 45 - depth : min. 70 mm - depth for driver in ceiling : min. 110 mm
LED included - Wall & ceiling -

REQUIRED DRIVER (REMOTE MOUNTING)							
DEVICE	DIM.	DRIVER	NET PRICE	DEVICE	DIM.	DRIVER	NET PRICE
1 x	NO	N 6W	11,20€	1-2 x	1-10 PU	D 15WP*	20,65€
	LC	D 10WT	14,65€		DA	D 15WDA*	22,60€
2 x	LC	D 18WT	16,95€	2-6 x	1-10 PU	D 40WP*	44,65€
					DA PU DA	D 40WD*	46,65€

driver does not fit through cutout hole of fixture
 *110V-230V

**For warranty use only Trizo21® supplied LED drivers as mentioned.
 For all specs and techs about drivers, see www.trizo21.com/drivers**

INSIDE RING

INSIDE RING

RETAIL PRICE
 VAT. EXCL.

BOULY 4 (for false ceiling)

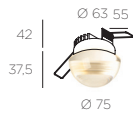

BOWW 6010 ◆ | 289€

350mA - **driver required (remote mounting)** see below
 1 x 4 LED 0.96W - 350mA - 456lm - 2700K (on demand 6000K) - CRI >93 - **dimmable**
 aperture : Ø 65 - depth : min. 50 mm, depth for driver in ceiling : min. 60 mm
 ◆ Choose beam: N=narrow 10° or M=medium 25° or W=wide 40°
LED included - Ceiling -

REQUIRED DRIVER (REMOTE MOUNTING)							
DEVICE	DIM.	DRIVER	NET PRICE	DEVICE	DIM.	DRIVER	NET PRICE
1 x	NO	N 4W	7,90€	1-3 x	1-10 PU	D 15WP*	20,65€
	1-10 PU	D 6WP	11,20€		DA	D 15WDA*	22,60€
	C	D 6WI	9,50€		2-8 x	1-10 PU	D 40WP*
1-2 x	NO	N 12W**	18,65€	1-10 PU DA		D 40WD*	46,65€

driver does not fit through cutout hole of fixture
 *110V-230V **IP 65

**For warranty use only Trizo21® supplied LED drivers as mentioned.
 For all specs and techs about drivers, see www.trizo21.com/drivers**

BOULY 4C (for concrete ceiling)



BOWW 6012 ◆ | 299€

350mA - **driver required (remote mounting)** see below
 1 x 4 LED 0.96W - 350mA - 456lm - 2700K (on demand 6000K) - CRI >93 - **dimmable**
 aperture : Ø 65 - depth : min. 60 mm, depth for driver in ceiling : min. 120 mm
 ◆ Choose beam: N=narrow 10° or M=medium 25° or W=wide 40°
LED included - Ceiling -

REQUIRED DRIVER (REMOTE MOUNTING)							
DEVICE	DIM.	DRIVER	NET PRICE	DEVICE	DIM.	DRIVER	NET PRICE
1 x	NO	N 4W	7,90€	1-3 x	1-10 PU	D 15WP*	20,65€
	1-10 PU	D 6WP	11,20€		DA	D 15WDA*	22,60€
	C	D 6WI	9,50€		2-8 x	1-10 PU	D 40WP*
1-2 x	NO	N 12W**	18,65€	1-10 PU DA		D 40WD*	46,65€

driver does not fit through cutout hole of fixture
 *110V-230V **IP 65

**For warranty use only Trizo21® supplied LED drivers as mentioned.
 For all specs and techs about drivers, see www.trizo21.com/drivers**

BOULY 16 (for false ceiling)



BOIN 1600 | 299€
 BOIN 1608 | 315€

350mA - **driver required (remote mounting)** see below
 1 x LED array 11W - 350mA - 1125lm - 2700K - CRI >97 - **dimmable**
 aperture : Ø 65 - depth : min. 50 mm, depth for driver in ceiling : min. 60 mm
LED included - Ceiling -

REQUIRED DRIVER (REMOTE MOUNTING)							
DEVICE	DIM.	DRIVER	NET PRICE	DEVICE	DIM.	DRIVER	NET PRICE
1 x	NO	N 12W**	18,65€	1 x	DA	D 15WDA*	22,60€
	LC	D 18WT	16,95€		1-3 x	1-10 PU	D 40WP*
	1-10 PU	D 15WP*	20,65€	DA		D 40WD*	46,65€

driver does not fit through cutout hole of fixture
 *110V-230V **IP 65

**For warranty use only Trizo21® supplied LED drivers as mentioned.
 For all specs and techs about drivers, see www.trizo21.com/drivers**

INSIDE RING
 INSIDE RING
 RETAIL PRICE
 VAT. EXCL.

BOULY 16C (for concrete ceiling)



BOIN 1602 | 309€
 BOIN 1680 | 325€

350mA - **driver required (remote mounting)** see below
 1 x LED array 11W - 350mA - 1125lm - 2700K - CRI >97 - **dimmable**
 aperture : Ø 65 - depth : min. 70 mm, depth for driver in ceiling : min. 130 mm
LED included - Ceiling -

REQUIRED DRIVER (REMOTE MOUNTING)

DEVICE	DIM.	DRIVER	NET PRICE	DEVICE	DIM.	DRIVER	NET PRICE
1 x	NO LC 1-10 PU	N 12W** D 18WT D 15WP*	18,65€ 16,95€ 20,65€	1 x	DA 1-10 PU DA PU DA	D 15WDA* D 40WP* D 40WD*	22,60€ 44,65€ 46,65€

driver does not fit through cutout hole of fixture
 *110V-230V **IP 65

**For warranty use only Trizo21® supplied LED drivers as mentioned.
 For all specs and techs about drivers, see www.trizo21.com/drivers**

MINI-PI 1 IN (for false ceiling)



FRAME
 FRAME
 FRAME
 RETAIL PRICE
 VAT. EXCL.

MIPI 1225 ◆ MIPI 1115 ◆ MIPI 1445 ◆ | 200€

350mA - **driver required (remote mounting)** see below
 1 x 4 LED 0.96W - 350mA - 456lm - 2700K (on demand 6000K) - CRI >93 - **dimmable**
 aperture : Ø 45 - depth : min. 35 mm - depth for driver in ceiling : min. 100 mm
 ◆ Choose beam: N=narrow 10° or M=medium 25° or W=wide 40°
LED included - Wall & ceiling -

REQUIRED DRIVER (REMOTE MOUNTING)

DEVICE	DIM.	DRIVER	NET PRICE	DEVICE	DIM.	DRIVER	NET PRICE
1 x	NO 1-10 PU C LC	N 4W D 6WP D 6WI D 18WT	7,90€ 11,20€ 9,50€ 16,95€	1-3 x	1-10 PU DA 1-10 PU 1-10 PU DA	D 15WP* D 15WDA* D 40WP* D 40WD*	20,65€ 22,60€ 44,65€ 46,65€

driver does not fit through cutout hole of fixture
 *110V-230V

**For warranty use only Trizo21® supplied LED drivers as mentioned.
 For all specs and techs about drivers, see www.trizo21.com/drivers**

MINI-PI 1C IN (for concrete ceiling)

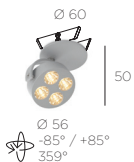

MIPI 1235 ◆ MIPI 1125 ◆ MIPI 1455 ◆ | 200€

350mA - **driver required (remote mounting)** see below
 1 x 4 LED 0.96W - 350mA - 456lm - 2700K (on demand 6000K) - CRI >93 - **dimmable**
 aperture : Ø 45 - depth : min. 35 mm - depth for driver in ceiling : min. 100 mm
 ◆ Choose beam: N=narrow 10° or M=medium 25° or W=wide 40°
LED included - Wall & ceiling -

REQUIRED DRIVER (REMOTE MOUNTING)

DEVICE	DIM.	DRIVER	NET PRICE	DEVICE	DIM.	DRIVER	NET PRICE
1 x	NO 1-10 PU C LC	N 4W D 6WP D 6WI D 18WT	7,90€ 11,20€ 9,50€ 16,95€	1-3 x	1-10 PU DA 1-10 PU 1-10 PU DA	D 15WP* D 15WDA* D 40WP* D 40WD*	20,65€ 22,60€ 44,65€ 46,65€

driver does not fit through cutout hole of fixture
 *110V-230V

**For warranty use only Trizo21® supplied LED drivers as mentioned.
 For all specs and techs about drivers, see www.trizo21.com/drivers**

MINI-PI 2 IN (for false ceiling)



FRAME



FRAME



FRAME



RETAIL PRICE
 VAT. EXCL.

MIPI 2227 ◆ MIPI 2117 ◆ MIPI 2447 ◆ | 395€

350mA - **driver required (remote mounting)** see below
 2 x 4 LED 0.96W - 350mA - 2 x 456lm - 2700K (on demand 6000K) - CRI >93 - **dimable**
 aperture : 2 x Ø 45 - depth : min. 35 mm - depth for driver in ceiling : min. 100 mm
 ◆ **Choose beam:** N=narrow 10° or M=medium 25° or W=wide 40°
LED included - Wall & ceiling - CE IP40 eco

REQUIRED DRIVER (REMOTE MOUNTING)

DEVICE	DIM.	DRIVER	NET PRICE	DEVICE	DIM.	DRIVER	NET PRICE
1 x	LC	D 10WT	14,65€	1-4 x	1-10 PU	D 40WP*	44,65€
	1-10 PU	D 15WP*	20,65€		1-10 PU DA	D 40WD*	46,65€
	DA	D 15WDA*	22,60€				

driver does not fit through cutout hole of fixture
 *110V-230V

For warranty use only Trizo21® supplied LED drivers as mentioned.
 For all specs and techs about drivers, see www.trizo21.com/drivers

FRAME



FRAME



FRAME



FRAME



FRAME



RETAIL PRICE
 VAT. EXCL.

PIN-IN 1 (for false ceiling)



PIIN 2101 PIIN 1101 PIIN 4101 PIIN 7101 PIIN 9101 | 109€
 159€

12V - **transformer excluded**
 G53 - 1 x R111 max. 100W or R111 LED
 aperture : Ø 60 - depth : min. 55
Bulb excluded - Wall & ceiling - CE IP20 eco

PIN-IN 1C (for concrete ceiling)



PIIN 2111 PIIN 1111 PIIN 4111 PIIN 7111 PIIN 9111 | 119€
 169€

12V - **transformer excluded**
 G53 - 1 x R111 max. 100W or R111 LED
 aperture : Ø 60 - depth : min. 20
Bulb excluded - Wall & ceiling - CE IP20 eco

PIN-IN 2 (for false ceiling)



PIIN 2102 PIIN 1102 PIIN 4102 PIIN 7102 PIIN 9102 | 208€
 284€

12V - **transformer excluded**
 G53 - 2 x R111 max. 100W or R111 LED
 aperture : 2 x Ø 60 - depth : min. 55
Bulbs excluded - Wall & ceiling - CE IP20 eco

R51 IN GU5.3



RING	FRAME INTERIOR	FRAME INTERIOR	FRAME INTERIOR	FRAME INTERIOR	FRAME INTERIOR	FRAME INTERIOR	FRAME INTERIOR	RETAIL PRICE VAT. EXCL.
●	● ●	● ○	○ ●	○ ○	● ●	● ○		
○	MRIN 1222	MRIN 1122	MRIN 1212	MRIN 1112	MRIN 1242	MRIN 1142		137€
○	MRIN 1229	MRIN 1129	MRIN 1219	MRIN 1119	MRIN 1249	MRIN 1149		192€
○	MRIN 1224	MRIN 1124	MRIN 1214	MRIN 1114	MRIN 1244	MRIN 1144		137€
○	MRIN 1221	MRIN 1121	MRIN 1211	MRIN 1111	MRIN 1241	MRIN 1141		137€

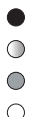

FRAME INTERIOR	FRAME INTERIOR	RETAIL PRICE VAT. EXCL.	
○ ●	MRIN 1292	MRIN 1192	180€
○ ●	MRIN 1299	MRIN 1199	235€
○ ●	MRIN 1294	MRIN 1194	180€
○ ●	MRIN 1291	MRIN 1191	180€

12V - **transformer excluded**
 GU5.3 - 1 x HALO QR-CBC51 (alu reflector / no cool beam) max. 50W or 1 x LED
 aperture : L 84 W 92 H 66 - depth : min. 90
Bulb excluded - Ceiling -

ACCESSORY FOR CONCRETE CEILING



CONC 0051 | 43€

concrete box: L 87 W 97 H 106
 aperture: L 90 W 100 H 108

R51 RIMLESS GU5.3

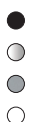
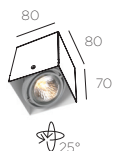

INTERIOR	INTERIOR	RETAIL PRICE VAT. EXCL.
●	○	
MRRI 1222	MRRI 1122	106€
MRRI 1229	MRRI 1199	160€
MRRI 1224	MRRI 1144	106€
MRRI 1211	MRRI 1111	106€

12V - **transformer excluded - installation kit required**
 GU5.3 - 1 x HALO QR-CBC51 (alu reflector / no cool beam) max. 50W or 1 x LED
Bulb excluded - Ceiling -

REQUIRED INSTALLATION KIT FOR RIMLESS

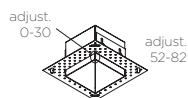

PLAS 0051 | 72€

installation kit: L 145 W 145 H 82
 aperture: L 100 W 90 H 84

R52 IN GU5.3

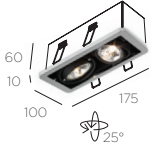

RING	FRAME INTERIOR	FRAME INTERIOR	FRAME INTERIOR	FRAME INTERIOR	FRAME INTERIOR	FRAME INTERIOR	FRAME INTERIOR	RETAIL PRICE VAT. EXCL.
●	● ●	● ○	○ ●	○ ○	● ●	● ○		198€
○	MRIN 2222	MRIN 2122	MRIN 2212	MRIN 2112	MRIN 2242	MRIN 2142		198€
○	MRIN 2229	MRIN 2129	MRIN 2219	MRIN 2119	MRIN 2249	MRIN 2149		296€
○	MRIN 2224	MRIN 2124	MRIN 2214	MRIN 2114	MRIN 2244	MRIN 2144		198€
○	MRIN 2221	MRIN 2121	MRIN 2211	MRIN 2111	MRIN 2241	MRIN 2141		198€
●					MRIN 2292	MRIN 2192		253€
○					MRIN 2299	MRIN 2199		350€
○					MRIN 2294	MRIN 2194		253€
○					MRIN 2291	MRIN 2191		253€

12V - **transformer excluded**
 GU5.3 - 2 x HALO QR-CBC51 (alu reflector / no cool beam) max. 50W or 2 x LED
 aperture : L 159 W 92 H 66 - depth : min. 90
Bulbs excluded - Ceiling -

ACCESSORY FOR CONCRETE CEILING

CONC 0052 | 48€

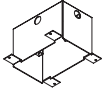

concrete box: L 162 W 97 H 106
 aperture: L 165 W 100 H 108

R52 RIMLESS GU5.3

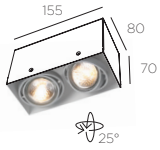

	INTERIOR	INTERIOR	RETAIL PRICE VAT. EXCL.
●	●	○	
○	MRR 2222	MRR 2122	151€
○	MRR 2229	MRR 2129	249€
○	MRR 2224	MRR 2124	151€
○	MRR 2221	MRR 2121	151€

12V - **transformer excluded - installation kit required**
 GU5.3 - 2 x HALO QR-CBC51 (alu reflector / no cool beam) max. 50W or 2 x LED
Bulbs excluded - Ceiling -

REQUIRED INSTALLATION KIT FOR RIMLESS

PLAS 0052 | 77€

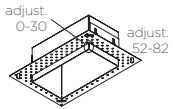

installation kit: L 220 W 145 H 82
 aperture: L 175 W 90 H 84

RING	FRAME	INTERIOR
●	●	●
○	○	○
●	○	○
○	●	●
○	○	○
○	○	○
○	○	○

R54 IN GU5.3

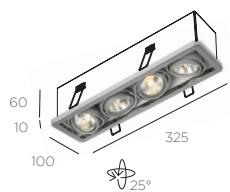

RING	FRAME	INTERIOR	MODEL	RETAIL PRICE VAT. EXCL.
●	●	●	MRIN 4222	296€
○	○	○	MRIN 4229	509€
○	○	○	MRIN 4224	296€
○	○	○	MRIN 4221	296€
○	○	○	MRIN 4122	
○	○	○	MRIN 4129	
○	○	○	MRIN 4124	
○	○	○	MRIN 4121	
○	○	○	MRIN 4212	
○	○	○	MRIN 4219	
○	○	○	MRIN 4214	
○	○	○	MRIN 4211	
○	○	○	MRIN 4112	
○	○	○	MRIN 4119	
○	○	○	MRIN 4114	
○	○	○	MRIN 4111	
○	○	○	MRIN 4242	
○	○	○	MRIN 4249	
○	○	○	MRIN 4244	
○	○	○	MRIN 4241	
○	○	○	MRIN 4142	
○	○	○	MRIN 4149	
○	○	○	MRIN 4144	
○	○	○	MRIN 4141	

RING	FRAME	INTERIOR	MODEL	RETAIL PRICE VAT. EXCL.
○	○	○	MRIN 4292	362€
○	○	○	MRIN 4299	563€
○	○	○	MRIN 4294	362€
○	○	○	MRIN 4291	362€
○	○	○	MRIN 4192	
○	○	○	MRIN 4199	
○	○	○	MRIN 4194	
○	○	○	MRIN 4191	

12V - **transformer excluded**
 GU5.3 - 4 x HALO QR-CBC51 (alu reflector / no cool beam) max. 50W or 4 x LED
 aperture : L 309 W 92 H 66 - depth : min. 90
Bulbs excluded - Ceiling - CE IP20 Eco

ACCESSORY FOR CONCRETE CEILING

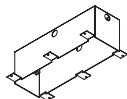

CONC 0054 | 62€

concrete box: L 312 W 97 H 106
 aperture: L 315 W 100 H 108

INTERIOR	MODEL	RETAIL PRICE VAT. EXCL.
●	MRRI 4222	222€
○	MRRI 4122	
○	MRRI 4229	435€
○	MRRI 4129	
○	MRRI 4224	222€
○	MRRI 4124	
○	MRRI 4221	222€
○	MRRI 4121	

R54 RIMLESS GU5.3

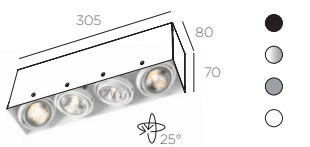

○	MRRI 4222	MRRI 4122	222€
○	MRRI 4229	MRRI 4129	435€
○	MRRI 4224	MRRI 4124	222€
○	MRRI 4221	MRRI 4121	222€

12V - **transformer excluded - installation kit required**
 GU5.3 - 4 x HALO QR-CBC51 (alu reflector / no cool beam) max. 50W or 4 x LED
Bulbs excluded - Ceiling - CE IP20 Eco

REQUIRED INSTALLATION KIT FOR RIMLESS

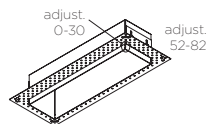

PLAS 0054 | 89€

installation kit: L 370 W 145 H 82
 aperture: L 325 W 90 H 84

R51 IN GU10

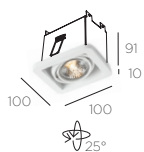

RING	FRAME INTERIOR	FRAME INTERIOR	FRAME INTERIOR	FRAME INTERIOR	FRAME INTERIOR	FRAME INTERIOR	FRAME INTERIOR	RETAIL PRICE VAT. EXCL.
●	● ●	● ○	○ ●	○ ○	● ●	● ○		137€
○	MIGU 1222	MIGU 1122	MIGU 1212	MIGU 1112	MIGU 1242	MIGU 1142		137€
○	MIGU 1229	MIGU 1129	MIGU 1219	MIGU 1119	MIGU 1249	MIGU 1149		192€
○	MIGU 1224	MIGU 1124	MIGU 1214	MIGU 1114	MIGU 1244	MIGU 1144		137€
○	MIGU 1221	MIGU 1121	MIGU 1211	MIGU 1111	MIGU 1241	MIGU 1141		137€
●					FRAME INTERIOR	FRAME INTERIOR		
○					● ●	● ○		180€
○					MIGU 1292	MIGU 1192		180€
○					MIGU 1299	MIGU 1199		235€
○					MIGU 1294	MIGU 1194		180€
○					MIGU 1291	MIGU 1191		180€

230V
GU10 - 1 x HALO QPAR16 (alu reflector / no cool beam) max. 50W or 1 x GU10 LED
aperture : L 84 W 92 H 97 - depth : min. 90
Bulb excluded - Ceiling -

ACCESSORY FOR CONCRETE CEILING

COGU 0051 | 43€



concrete box: L 87 W 97 H 112
aperture: L 90 W 100 H 120

R52 IN GU10

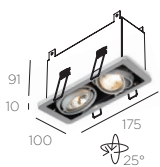

RING	FRAME INTERIOR	FRAME INTERIOR	FRAME INTERIOR	FRAME INTERIOR	FRAME INTERIOR	FRAME INTERIOR	FRAME INTERIOR	RETAIL PRICE VAT. EXCL.
●	● ●	● ○	○ ●	○ ○	● ●	● ○		198€
○	MIGU 2222	MIGU 2122	MIGU 2212	MIGU 2112	MIGU 2242	MIGU 2142		198€
○	MIGU 2229	MIGU 2129	MIGU 2219	MIGU 2119	MIGU 2249	MIGU 2149		296€
○	MIGU 2224	MIGU 2124	MIGU 2214	MIGU 2114	MIGU 2244	MIGU 2144		198€
○	MIGU 2221	MIGU 2121	MIGU 2211	MIGU 2111	MIGU 2241	MIGU 2141		198€
●					FRAME INTERIOR	FRAME INTERIOR		
○					● ●	● ○		253€
○					MIGU 2292	MIGU 2192		253€
○					MIGU 2299	MIGU 2199		350€
○					MIGU 2294	MIGU 2194		253€
○					MIGU 2291	MIGU 2191		253€

230V - GU10 - 2 x HALO QPAR16 (alu reflector / no cool beam) max. 50W or 2 x GU10 LED
aperture : L 159 W 92 H 97 - depth : min. 90
Bulb excluded - Ceiling -

ACCESSORY FOR CONCRETE CEILING

COGU 0052 | 48€



concrete box: L 162 W 97 H 112
aperture: L 165 W 100 H 120

R54 IN GU10

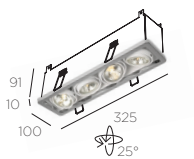

RING	FRAME INTERIOR	FRAME INTERIOR	FRAME INTERIOR	FRAME INTERIOR	FRAME INTERIOR	FRAME INTERIOR	FRAME INTERIOR	RETAIL PRICE VAT. EXCL.
●	● ●	● ○	○ ●	○ ○	● ●	● ○		296€
○	MIGU 4222	MIGU 4122	MIGU 4212	MIGU 4112	MIGU 4242	MIGU 4142		296€
○	MIGU 4229	MIGU 4129	MIGU 4219	MIGU 4119	MIGU 4249	MIGU 4149		509€
○	MIGU 4224	MIGU 4124	MIGU 4214	MIGU 4114	MIGU 4244	MIGU 4144		296€
○	MIGU 4221	MIGU 4121	MIGU 4211	MIGU 4111	MIGU 4241	MIGU 4141		296€
	●				○ ●	○ ○		
	○							
	○							
	○							
					MIGU 4292	MIGU 4192		362€
					MIGU 4299	MIGU 4199		563€
					MIGU 4294	MIGU 4194		362€
					MIGU 4291	MIGU 4191		362€

230V
 GU10 - 4 x HALO QPAR16 (alu reflector / no cool beam) max. 50W or 4 x GU10 LED
 aperture : L 309 W 92 H 97 - depth : min. 90
Bulbs excluded - Ceiling -

ACCESSORY FOR CONCRETE CEILING

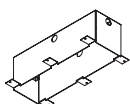

COGU 0054 | 62€

concrete box: L 312 W 97 H 112
 aperture: L 315 W 100 H 120

R51 IN LED



RING	FRAME	INTERIOR	FRAME	INTERIOR	FRAME	INTERIOR	FRAME	INTERIOR	FRAME	INTERIOR	FRAME	INTERIOR	RETAIL PRICE VAT: EXCL.
●	●	●	●	○	○	○	○	○	●	●	●	○	250€
●	●	●	○	○	○	○	○	○	●	○	○	○	250€
○	○	○	○	○	○	○	○	○	○	○	○	○	250€
●	○	○	○	○	○	○	○	○	○	○	○	○	290€
○	○	○	○	○	○	○	○	○	○	○	○	○	290€
○	○	○	○	○	○	○	○	○	○	○	○	○	290€

350mA - **driver required (remote mounting)** see below
 1 x 4 LED 0.96W - 350mA - 456lm - 2700K (on demand 6000K) - CRI >93 - **dimmable**
 aperture : L 84 W 92 H 66 - depth : min. 90
 ♦ Choose beam: N=narrow 10° or M=medium 25° or W=wide 40°
LED included - Ceiling -

REQUIRED DRIVER (REMOTE MOUNTING)							
DEVICE	DIM.	DRIVER	NET PRICE	DEVICE	DIM.	DRIVER	NET PRICE
1 x	NO 1-10 PU C	N 4W D 6WP D 6WI	7,90€ 11,20€ 9,50€	1-3 x	1-10 PU DA	D 15WP* D 15WDA*	20,65€ 22,60€
				2-8 x	1-10 PU 1-10 PU DA	D 40WP* D 40WD*	44,65€ 46,65€

driver does not fit through cutout hole of fixture
 *110V-230V

**For warranty use only Trizo21® supplied LED drivers as mentioned.
 For all specs and techs about drivers, see www.trizo21.com/drivers**

ACCESSORY FOR CONCRETE CEILING



CONC 0051 | 43€

concrete box: L 87 W 97 H 106
 aperture: L 90 W 100 H 108

R51 RIMLESS LED



	INTERIOR	INTERIOR	RETAIL PRICE VAT: EXCL.
●	●	○	220€
○	○	○	220€
○	○	○	220€

350mA - **driver required (remote mounting)** see below - **installation kit required**
 1 x 4 LED 0.96W - 350mA - 456lm - 2700K (on demand 6000K) - CRI >93 - **dimmable**
 ♦ Choose beam: N=narrow 10° or M=medium 25° or W=wide 40°
LED included - Ceiling -

REQUIRED DRIVER (REMOTE MOUNTING)							
DEVICE	DIM.	DRIVER	NET PRICE	DEVICE	DIM.	DRIVER	NET PRICE
1 x	NO 1-10 PU C	N 4W D 6WP D 6WI	7,90€ 11,20€ 9,50€	1-3 x	1-10 PU DA	D 15WP* D 15WDA*	20,65€ 22,60€
				2-8 x	1-10 PU 1-10 PU DA	D 40WP* D 40WD*	44,65€ 46,65€

driver does not fit through cutout hole of fixture
 *110V-230V

**For warranty use only Trizo21® supplied LED drivers as mentioned.
 For all specs and techs about drivers, see www.trizo21.com/drivers**

REQUIRED INSTALLATION KIT FOR RIMLESS

PLAS 0051 | 72€

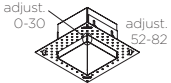

installation kit: L 145 W 145 H 82
 aperture: L 100 W 90 H 84

R52 IN LED

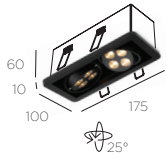

RING	FRAME	INTERIOR	FRAME	INTERIOR	FRAME	INTERIOR	FRAME	INTERIOR	FRAME	INTERIOR	FRAME	INTERIOR	RETAIL PRICE VAT. EXCL.
●	●		●	○	○	●	○	○	●	●	○	○	459€
●			●		○			○			○		459€
○			○		○			○			○		459€
●									●	●			
○									○	○			
●											MIWW 2292	MIWW 2192	510€
○											MIWW 2294	MIWW 2194	510€
○											MIWW 2291	MIWW 2191	510€

350mA - **driver required (remote mounting)** see below

2 x 4 LED 0.96W - 350mA - 2 x 456lm - 2700K (on demand 6000K) - CRI >93 - **dimmable**

aperture : L 159 W 92 H 66 - depth : min. 90

◆ Choose beam: N=narrow 10° or M=medium 25° or W=wide 40°

LED included - Ceiling -

REQUIRED DRIVER (REMOTE MOUNTING)

DEVICE	DIM.	DRIVER	NET PRICE	DEVICE	DIM.	DRIVER	NET PRICE
1 x	NO 1-10 PU DA	D 10WT D 15WP* D 15WDA*	14,65€ 20,65€ 22,60€	1-4 x	1-10 PU 1-10 PU DA	D 40WP* D 40WD*	44,65€ 46,65€

driver does not fit through cutout hole of fixture
*110V-230V

**For warranty use only Trizo21® supplied LED drivers as mentioned.
For all specs and techs about drivers, see www.trizo21.com/drivers**

ACCESSORY FOR CONCRETE CEILING

CONC 0052 | 48€

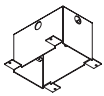

concrete box: L 162 W 97 H 106

aperture: L 165 W 100 H 108

R52 RIMLESS LED

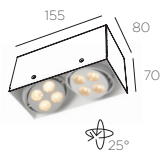

	INTERIOR	INTERIOR	RETAIL PRICE VAT. EXCL.
●		○	
○			
○			

MRWW 2202 ◆ MRWW 2102 ◆ | 414€

MRWW 2204 ◆ MRWW 2104 ◆ | 414€

MRWW 2201 ◆ MRWW 2101 ◆ | 414€

350mA - **driver required (remote mounting)** see below - **installation kit required**

2 x 4 LED 0.96W - 350mA - 2 x 456lm - 2700K (on demand 6000K) - CRI >93 - **dimmable**

◆ Choose beam: N=narrow 10° or M=medium 25° or W=wide 40°

LED included - Ceiling -

REQUIRED DRIVER (REMOTE MOUNTING)

DEVICE	DIM.	DRIVER	NET PRICE	DEVICE	DIM.	DRIVER	NET PRICE
1 x	NO 1-10 PU DA	D 10WT D 15WP* D 15WDA*	14,65€ 20,65€ 22,60€	1-4 x	1-10 PU 1-10 PU DA	D 40WP* D 40WD*	44,65€ 46,65€

driver does not fit through cutout hole of fixture
*110V-230V

**For warranty use only Trizo21® supplied LED drivers as mentioned.
For all specs and techs about drivers, see www.trizo21.com/drivers**

REQUIRED INSTALLATION KIT FOR RIMLESS

PLAS 0052 | 72€

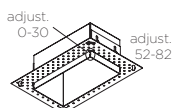

installation kit: L 220 W 145 H 82

aperture: L 175 W 90 H 84

R54 IN LED

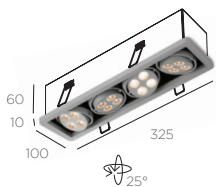

RING	FRAME	INTERIOR	FRAME	INTERIOR	FRAME	INTERIOR	FRAME	INTERIOR	FRAME	INTERIOR	FRAME	INTERIOR	FRAME	INTERIOR	RETAIL PRICE VAT. EXCL.
●	●		●	○	○	●	○	○	○	○	●	●	○	○	832€
●	○		●	○	○	○	○	○	○	○	○	○	○	○	832€
○	○		○	○	○	○	○	○	○	○	○	○	○	○	832€
●															
○															

FRAME	INTERIOR	FRAME	INTERIOR	RETAIL PRICE VAT. EXCL.
○	○	○	○	890€
○	○	○	○	890€
○	○	○	○	890€

350mA - **driver required (remote mounting)** see below

4 x 4 LED 0.96W - 350mA - 4 x 456lm - 2700K (on demand 6000K) - CRI >93 - **dimmable**

aperture : L 309 W 92 H 66 - depth : min. 90

◆ Choose beam: N=narrow 10° or M=medium 25° or W=wide 40°

LED included - Ceiling - CE IP40 eco

REQUIRED DRIVER (REMOTE MOUNTING)

DEVICE	DIM.	DRIVER	NET PRICE
1-2 x	1-10 PU	D 40WP*	44,65€

driver does not fit through cutout hole of fixture
*110V-230V

DEVICE	DIM.	DRIVER	NET PRICE
1-2 x	1-10 PU DA	D 40WD*	46,65€

For warranty use only Trizo21® supplied LED drivers as mentioned.
For all specs and techs about drivers, see www.trizo21.com/drivers

ACCESSORY FOR CONCRETE CEILING

CONC 0054 | 62€

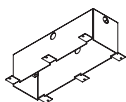

concrete box: L 312 W 97 H 106

aperture: L 315 W 100 H 108

R54 RIMLESS LED

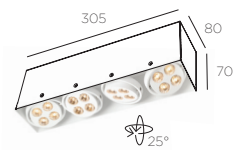

	INTERIOR	INTERIOR	RETAIL PRICE VAT. EXCL.
●	●	○	761€
○	○	○	761€
○	○	○	761€

350mA - **driver required (remote mounting)** see below - **installation kit required**

4 x 4 LED 0.96W - 350mA - 4 x 456lm - 2700K (on demand 6000K) - CRI >93 - **dimmable**

◆ Choose beam: N=narrow 10° or M=medium 25° or W=wide 40°

LED included - Ceiling - CE IP40 eco

REQUIRED DRIVER (REMOTE MOUNTING)

DEVICE	DIM.	DRIVER	NET PRICE
1-2 x	1-10 PU	D 40WP*	44,65€

driver does not fit through cutout hole of fixture
*110V-230V

DEVICE	DIM.	DRIVER	NET PRICE
1-2 x	1-10 PU DA	D 40WD*	46,65€

For warranty use only Trizo21® supplied LED drivers as mentioned.
For all specs and techs about drivers, see www.trizo21.com/drivers

REQUIRED INSTALLATION KIT FOR RIMLESS

PLAS 0054 | 89€

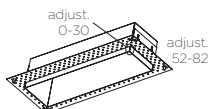

installation kit: L 370 W 145 H 82

aperture: L 325 W 90 H 84

R07 IN

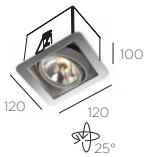

RING	FRAME	INTERIOR	FRAME	INTERIOR	FRAME	INTERIOR	FRAME	INTERIOR	FRAME	INTERIOR	FRAME	INTERIOR	RETAIL PRICE VAT. EXCL.
●	●	●	●	○	○	○	○	○	●	●	○	○	187€
○	○	○	○	○	○	○	○	○	○	○	○	○	230€
●	○	○	○	○	○	○	○	○	○	○	○	○	187€
○	○	○	○	○	○	○	○	○	○	○	○	○	187€
●									○	○			
○									○	○			
○									○	○			
○									○	○			
									○	○			
									○	○			
									○	○			
									○	○			
									○	○			
									○	○			
									○	○			
									○	○			
									○	○			
									○	○			
									○	○			
									○	○			
									○	○			
									○	○			

12V - **transformer excluded**
 BA15d - 1 x QR70 max. 50W. LED version available on demand.
 aperture : L 104 W 106 H 105
Bulb excluded - Ceiling - CE IP20 eco

ACCESSORY FOR CONCRETE CEILING

CONC 0007 | 49€



concrete box: L 105 W 112 H 106
 aperture: L 108 W 115 H 108

R07 RIMLESS



	INTERIOR	INTERIOR	RETAIL PRICE VAT. EXCL.
●	●	○	134€
○	○	○	176€
○	○	○	134€
○	○	○	134€

12V - **transformer excluded - installation kit required**
 BA15d - 1 x QR70 max. 50W. LED version available on demand.
Bulb excluded - Ceiling - CE IP20 eco

REQUIRED INSTALLATION KIT FOR RIMLESS

PLAS 0007 | 75€

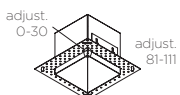

installation kit: L 165 W 165 H 111
 aperture: L 120 W 110 H 113

R70 IN



RING	FRAME INTERIOR	FRAME INTERIOR	FRAME INTERIOR	FRAME INTERIOR	FRAME INTERIOR	FRAME INTERIOR	FRAME INTERIOR	RETAIL PRICE VAT: EXCL.
● ●	ARIN 7222	ARIN 7122	ARIN 7212	ARIN 7112	ARIN 7242	ARIN 7142	263€	
● ○	ARIN 7229	ARIN 7129	ARIN 7219	ARIN 7119	ARIN 7249	ARIN 7149	410€	
● ○	ARIN 7224	ARIN 7124	ARIN 7214	ARIN 7114	ARIN 7244	ARIN 7144	263€	
○ ○	ARIN 7221	ARIN 7121	ARIN 7211	ARIN 7111	ARIN 7241	ARIN 7141	263€	
●								
○								
○								
○								

FRAME INTERIOR	FRAME INTERIOR	RETAIL PRICE VAT: EXCL.	
○ ●	ARIN 7292	ARIN 7192	318€
○ ●	ARIN 7299	ARIN 7199	465€
○ ●	ARIN 7294	ARIN 7194	318€
○ ●	ARIN 7291	ARIN 7191	318€

12V - transformer excluded
 BA15d - 2 x QR70 max. 50W. LED version available on demand.
 aperture : L 204 W 106 H 105
Bulbs excluded - Ceiling - CE IP20 eco

ACCESSORY FOR CONCRETE CEILING

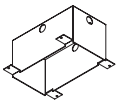

CONC 0070 | 69€

concrete box: L 205 W 112 H 106
 aperture: L 208 W 115 H 108

R70 RIMLESS

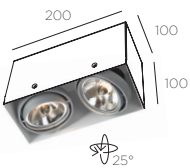

	INTERIOR	INTERIOR	RETAIL PRICE VAT: EXCL.
●	ARRI 7222	ARRI 7122	200€
○	ARRI 7229	ARRI 7129	347€
○	ARRI 7224	ARRI 7124	200€
○	ARRI 7221	ARRI 7121	200€

12V - transformer excluded - **installation kit required**
 BA15d - 2 x QR70 max. 50W. LED version available on demand.
Bulbs excluded - Ceiling - CE IP20 eco

REQUIRED INSTALLATION KIT FOR RIMLESS

PLAS 0070 | 89€

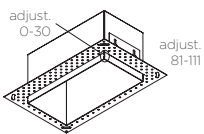

installation kit: L 265 W 165 H 111
 aperture: L 220 W 110 H 113

R110 IN G53



RING	FRAME INTERIOR	FRAME INTERIOR	FRAME INTERIOR	FRAME INTERIOR	FRAME INTERIOR	FRAME INTERIOR	FRAME INTERIOR	RETAIL PRICE VAT: EXCL.
● ●	ARIN 0222	ARIN 0122	ARIN 0212	ARIN 0112	ARIN 0242	ARIN 0142	198€	
● ●	ARIN 0229	ARIN 0129	ARIN 0219	ARIN 0119	ARIN 0249	ARIN 0149	268€	
● ●	ARIN 0224	ARIN 0124	ARIN 0214	ARIN 0114	ARIN 0244	ARIN 0144	198€	
○ ○	ARIN 0221	ARIN 0121	ARIN 0211	ARIN 0111	ARIN 0241	ARIN 0141	198€	



FRAME INTERIOR	FRAME INTERIOR	RETAIL PRICE VAT: EXCL.	
● ●	ARIN 0292	ARIN 0192	253€
● ●	ARIN 0299	ARIN 0199	323€
● ●	ARIN 0294	ARIN 0194	253€
● ●	ARIN 0291	ARIN 0191	253€

12V - **transformer excluded**
 G53- 1 x R111 max. 100W or R111 LED
 aperture : L 149 W 151 H 80 - depth : min. 120
Bulb excluded - Ceiling -

ACCESSORY FOR CONCRETE CEILING



CONC 0110 | 63€

concrete box: L 152 W 158 H 120
 aperture: L 155 W 161 H 122

R110 RIMLESS

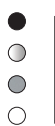

INTERIOR	INTERIOR	RETAIL PRICE VAT: EXCL.	
●	ARRI 0222	ARRI 0122	140€
●	ARRI 0229	ARRI 0129	209€
●	ARRI 0224	ARRI 0124	140€
●	ARRI 0221	ARRI 0121	140€

12V - **transformer excluded** - **installation kit required**
 G53 - 1 x R111 max. 100W or R111 LED
Bulb excluded - Ceiling -

REQUIRED INSTALLATION KIT FOR RIMLESS

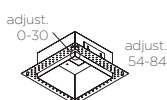

PLAS 0110 | 86€

installation kit: L 210 W 210 H 84
 aperture: L 165 W 155 H 8

R111 IN G53



RING	FRAME	INTERIOR	FRAME	INTERIOR	FRAME	INTERIOR	FRAME	INTERIOR	FRAME	INTERIOR	FRAME	INTERIOR	RETAIL PRICE VAT. EXCL.
●	●	●	○	○	○	○	●	●	●	○	●	○	285€
○	●	○	○	●	○	○	○	○	○	○	○	○	438€
○	○	○	○	○	○	○	○	○	○	○	○	○	285€
○	○	○	○	○	○	○	○	○	○	○	○	○	285€
○	○	○	○	○	○	○	○	○	○	○	○	○	285€
○	○	○	○	○	○	○	○	○	○	○	○	○	285€

FRAME	INTERIOR	FRAME	INTERIOR	RETAIL PRICE VAT. EXCL.
○	○	○	○	345€
○	○	○	○	497€
○	○	○	○	345€
○	○	○	○	345€

12V - **transformer excluded**
 G53 - 2 x R111 max. 100W or R111 LED
 aperture : L 289 W 151 H 80 - depth : min. 120
Bulbs excluded - Ceiling - CE IP20 eco

ACCESSORY FOR CONCRETE CEILING

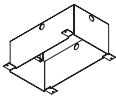

CONC 0111 | 78€

concrete box: L 292 W 158 H 120
 aperture: L 295 W 161 H 122

R111 RIMLESS

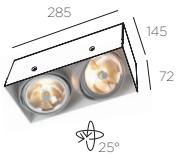

INTERIOR	INTERIOR	RETAIL PRICE VAT. EXCL.
●	○	216€
○	○	369€
○	○	216€
○	○	216€

12V - **transformer excluded - installation kit required**
 G53 - 2 x R111 max. 100W or R111 LED
Bulbs excluded - Ceiling - CE IP20 eco

REQUIRED INSTALLATION KIT FOR RIMLESS

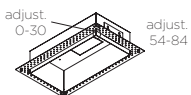

PLAS 0111 | 96€

installation kit: L 350 W 210 H 84
 aperture: L 305 W 155 H 86

Track



2THIRTY

2THIRTY 1 TRACK 230V	106
2THIRTY 1 TRACK 48V	106



AUSTERE-SOLITAIRE TRACK

AUSTERE-SOLITAIRE RF 75 TRACK	107
AUSTERE-SOLITAIRE RF 100 TRACK	107
AUSTERE-SOLITAIRE RL 75 TRACK	108



MINI-PI TRACK

MINI-PI 1 TRACK	108
MINI-PI 2 TRACK	108

ROD
FRAME
SWIVEL

● ● ●

RETAIL PRICE
VAT. EXCL.

2Thirty 1 Track 230V

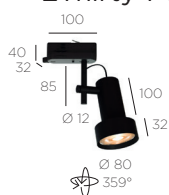

LC	●	2T2 12223	◆	375€
LC	●	2T2 17223	◆	375€
LC	●	2T2 18223	◆	375€

230V - TRIAC/IGBT dimmable

1 x LED Module 10W - 230V - 1000lm - 2700K - CRI >90

◆ Choose beam: N=narrow 12° or M=medium 24° or W=wide 40°

Optional ring with honeycomb: see below

LED included - Track 230V - CE IP50 eco

OPTIONAL RING + HONEYCOMB FOR 2THIRTY



●	TH 200RH	35€
●	TH 700RH	35€
●	TH 800RH	35€

2Thirty 1 Track 230V + honeycomb

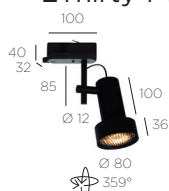

LC	●	2T2 12223H	◆	395€
LC	●	2T2 17223H	◆	395€
LC	●	2T2 18223H	◆	395€

230V - TRIAC/IGBT dimmable

1 x LED Module 10W - 230V - 1000lm - 2700K - CRI >90

◆ Choose beam: N=narrow 12° or M=medium 24° or W=wide 40°

Optional ring without honeycomb: see below

LED included - Track 230V - CE IP50 eco

OPTIONAL RING FOR 2THIRTY



●	TH 200R	23€
●	TH 700R	23€
●	TH 800R	23€

2Thirty 1 Track 48V



H0	●	2T4 12223	◆	325€
H0	●	2T4 17223	◆	325€
H0	●	2T4 18223	◆	325€

DA	●	2T4 12323	◆	325€
DA	●	2T4 17323	◆	325€
DA	●	2T4 18323	◆	325€

48V - non-dimmable or 1-10V or DALI dimmable

1 x LED array 11,8W - 350mA - 1241lm - 2700K - CRI >97

◆ Choose beam: N=narrow 12° or M=medium 24° or W=wide 40°

Optional ring with honeycomb: see below

LED included - Track 48V - CE IP50 eco

OPTIONAL RING + HONEYCOMB FOR 2THIRTY



●	TH 200RH	35€
●	TH 700RH	35€
●	TH 800RH	35€

2Thirty 1 Track 48V + honeycomb



DIM	RING	ROD	FRAME	SWIVEL	RETAIL PRICE VAT. EXCL.
		●	●	●	
1-10	●	2T4 12223H	◆		345€
1-10	●	2T4 17223H	◆		345€
1-10	●	2T4 18223H	◆		345€
DA	●	2T4 12323H	◆		345€
DA	●	2T4 17323H	◆		345€
DA	●	2T4 18323H	◆		345€

48V - non-dimmable or 1-10V or DALI dimmable

1 x LED array 11,8W - 350mA - 1241lm - 2700K - CRI >97

◆ Choose beam: N=narrow 12° or M=medium 24° or W=wide 40°

Optional ring without honeycomb: see below

LED included - Track 48V -

OPTIONAL RING FOR 2THIRTY



●	TH 200R	23€
●	TH 700R	23€
●	TH 800R	23€

AUSTERE-SOLITAIRE RF 75 TRACK 48V

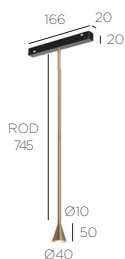

DIM	FRAME	FRAME	FRAME	FRAME	RETAIL PRICE VAT. EXCL.
	●	●	○	●	
1-10	HVSU 4873	HVSU 4872	HVSU 4871		380€
1-10				HVSU 4874	460€
DA	HVSU 4973	HVSU 4972	HVSU 4971		380€
DA				HVSU 4974	460€

48V - 1-10V or DALI dimmable

1 x LED array 6,2W - 350mA - 630lm - 2700K - CRI >98

LED included - Track 48V -

AUSTERE-SOLITAIRE RF 100 TRACK 48V

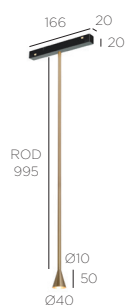

DIM	FRAME	FRAME	FRAME	FRAME	RETAIL PRICE VAT. EXCL.
	●	●	○	●	
1-10	HVSU 4893	HVSU 4892	HVSU 4891		390€
1-10				HVSU 4894	470€
DA	HVSU 4993	HVSU 4992	HVSU 4991		390€
DA				HVSU 4994	470€

48V - 1-10V or DALI dimmable

1 x LED array 6,2W - 350mA - 630lm - 2700K - CRI >98

LED included - Track 48V -

AUSTERE-SOLITAIRE RL 75 TRACK 48V new

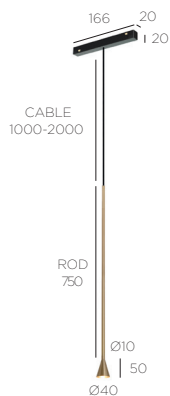

DIM	CABLE LENGTH	FRAME	CABLE	FRAME	CABLE	FRAME	CABLE	FRAME	CABLE	RETAIL PRICE VAT. EXCL.
I-HO	L 1000	●	●	●	●	○	○	●	●	425€
I-HO	L 1000							●	●	505€
I-HO	L 2000									435€
I-HO	L 2000							●	●	515€
DA	L 1000									425€
DA	L 1000							●	●	505€
DA	L 2000									435€
DA	L 2000							●	●	515€

48V - 1-10V or DALI dimmable

1 x LED array 6,2W - 350mA - 630lm - 2700K - CRI >98

Other cable lengths available on demand - LED included - Track 48V -

MINI-PI 1 TRACK 48V new



DIM	FRAME	FRAME	RETAIL PRICE VAT. EXCL.
I-HO	●	○	245€
DA	●	○	245€

48V - 1-10V or DALI dimmable

1 x 4 LED 0,96W - 350mA - 456lm - 2700K - CRI >93

◆ Choose beam: N=narrow 10° or M=medium 25° or W=wide 40°

LED included - Track 48V -

MINI-PI 2 TRACK 48V new



I-HO	◆	◆	440€
DA	◆	◆	440€

48V - 1-10V or DALI dimmable

2 x 4 LED 0,96W - 350mA - 2 x 456lm - 2700K - CRI >93

◆ Choose beam: N=narrow 10° or M=medium 25° or W=wide 40°

LED included - Track 48V -

Outdoor



BOULY OUT

BOULY 4 OUT	110
BOULY 16 OUT	110



CODE 1 / CODE 2 OUT

CODE 1 OUT	111
CODE 1 LED OUT	111
CODE 2 OUT	111
CODE 2 LED OUT	112



CODE W OUT

CODE W OUT	112
CODE W LED OUT	112

INSIDE RING

INSIDE RING

RETAIL PRICE
 VAT EXCL.



BOULY 4 OUT (for false ceiling)



BEWW 6010 ◆ | 330€

350mA - **driver required (remote mounting)** see below
 1 x 4 LED 0.96W - 350mA - 456lm - 2700K (on demand 6000K) - CRI >93 - **dimmable**
 aperture : Ø 65 - depth : min. 65 mm - depth for driver in ceiling : min. 60 mm
 ◆ Choose beam: N=narrow 10° or M=medium 25° or W=wide 40°
LED included - Ceiling -

REQUIRED DRIVER (REMOTE MOUNTING)							
DEVICE	DIM.	DRIVER	NET PRICE	DEVICE	DIM.	DRIVER	NET PRICE
1 x	NO	N 4W	7,90€	1-3 x	1-10 PU	D 15WP*	20,65€
	1-10 PU	D 6WP	11,20€		DA	D 15WDA*	22,60€
1-2 x	NO	N 12W**	18,65€	2-8 x	1-10 PU	D 40WP*	44,65€
2 x	LC	D 10WT	14,65€		1-10 PU DA	D 40WD*	46,65€

driver does not fit through cutout hole of fixture
 *110V-230V **IP 65

**For warranty use only Trizo21® supplied LED drivers as mentioned.
 For all specs and techs about drivers, see www.trizo21.com/drivers**

BOULY 4C OUT (for concrete ceiling)



BEWW 6012 ◆ | 340€

350mA - **driver required (remote mounting)** see below
 1 x 4 LED 0.96W - 350mA - 456lm - 2700K (on demand 6000K) - CRI >93 - **dimmable**
 aperture : Ø 65 - depth : min. 80 mm - depth for driver in ceiling : min. 120 mm
 ◆ Choose beam: N=narrow 10° or M=medium 25° or W=wide 40°
LED included - Ceiling -

REQUIRED DRIVER (REMOTE MOUNTING)							
DEVICE	DIM.	DRIVER	NET PRICE	DEVICE	DIM.	DRIVER	NET PRICE
1 x	NO	N 4W	7,90€	1-3 x	1-10 PU	D 15WP*	20,65€
	1-10 PU	D 6WP	11,20€		DA	D 15WDA*	22,60€
1-2 x	NO	N 12W**	18,65€	2-8 x	1-10 PU	D 40WP*	44,65€
2 x	LC	D 10WT	14,65€		1-10 PU DA	D 40WD*	46,65€

driver does not fit through cutout hole of fixture
 *110V-230V **IP 65

**For warranty use only Trizo21® supplied LED drivers as mentioned.
 For all specs and techs about drivers, see www.trizo21.com/drivers**

BOULY 16 OUT (for false ceiling)



BOEX 1600 | 340€
 BOEX 1608 | 356€

350mA - **driver required (remote mounting)** see below
 1 x LED array 11W - 350mA - 1125lm - 2700K - CRI >97 - **dimmable**
 aperture : Ø 65 - depth : min. 65 mm - depth for driver in ceiling : min. 60 mm
LED included - Ceiling -

REQUIRED DRIVER (REMOTE MOUNTING)							
DEVICE	DIM.	DRIVER	NET PRICE	DEVICE	DIM.	DRIVER	NET PRICE
1 x	NO	N 12W**	18,65€	1-3 x	1-10 PU	D 40WP*	44,65€
	LC	D 18WT	16,95€		1-10 PU DA	D 40WD*	46,65€
	1-10 PU	D 15WP*	20,65€				
	DA	D 15WDA*	22,60€				

driver does not fit through cutout hole of fixture
 *110V-230V **IP 65

**For warranty use only Trizo21® supplied LED drivers as mentioned.
 For all specs and techs about drivers, see www.trizo21.com/drivers**

	INSIDE RING	INSIDE RING	RETAIL PRICE VAT. EXCL.
	●	●	

BOULY 16C OUT (for concrete ceiling)

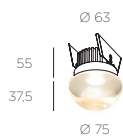

BOEX 1602	350€
BOEX 1680	366€

350mA - **driver required (remote mounting)** see below
 1 x LED array 11W - 350mA - 1125lm - 2700K - CRI >97 - **dimmable**
 aperture : Ø 65 - depth : min. 85 mm - depth for driver in ceiling : min. 130 mm
LED included - Ceiling -

REQUIRED DRIVER (REMOTE MOUNTING)

DEVICE	DIM.	DRIVER	NET PRICE	DEVICE	DIM.	DRIVER	NET PRICE
1 x	NO	N 12W**	18,65€	1-3 x	1-10 PU	D 40WP*	44,65€
	LC	D 18WT	16,95€		1-10 PU DA	D 40WD*	46,65€
	1-10 PU	D 15WP*	20,65€				
	DA	D 15WDA*	22,60€				

driver does not fit through cutout hole of fixture
 *110V-230V **IP 65

**For warranty use only Trizo21® supplied LED drivers as mentioned.
 For all specs and techs about drivers, see www.trizo21.com/drivers**

CODE 1 OUT



	VOLT	FRAME	FRAME	FRAME	RETAIL PRICE VAT. EXCL.
		●	○	●	
230V		COEX 3001	COEX 1001	COEX 2001	192€
12V		COEX 3121	COEX 1121	COEX 2121	192€

230V - GU10 - 1 x HALO QPAR16 max. 35W or 1 x GU10 LED
 12V - **transformer excluded** - GU5.3 - 1 x HALO QR-CBC51 (only alu reflector / no cool beam) max. 35W or 1 x LED
Bulb excluded - Ceiling -

CODE 1 LED OUT



COEX 2151	◆	COEX 1151	◆	COEX 7151	◆	322€
-----------	---	-----------	---	-----------	---	------

230V - **driver included in base - non-dimmable**
 1 x 4 LED 0.96W - 350mA - 456lm - 2700K (on demand 6000K) - CRI >93
 ◆ **Choose beam:** N=narrow 10° or M=medium 25° or W=wide 40°
LED included - Ceiling -

OPTIONAL COVER CODE 1 OUT & CODE 1 LED OUT



ACEX 7055	ACEX 2055	ACEX 1055	39€
-----------	-----------	-----------	-----

CODE 2 OUT



230V		COEX 3002	COEX 1002	COEX 2002	230€
12V		COEX 3122	COEX 1122	COEX 2122	230€

230V - GU10 - 2 x HALO QPAR16 max. 35W or 2 x GU10 LED
 12V - **transformer excluded** - GU5.3 - 2 x HALO QR-CBC51 (only alu reflector / no cool beam) max. 35W or 2 x LED
Bulbs excluded - Ceiling -

CODE 2 LED OUT

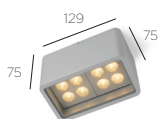

FRAME



FRAME



FRAME



RETAIL PRICE
 VAT. EXCL.

COEX 225I ◆ COEX 125I ◆ COEX 725I ◆ | 510€

230V - **driver included in base - non-dimmable**

1 x 8 LED 0.96W - 350mA - 2700K (on demand 6000K) - 912lm - CRI >93

◆ Choose beam: N=narrow 10° or M=medium 25° or W=wide 40°

LED included - Ceiling - CE ◆ IP55 eco

CODE W OUT

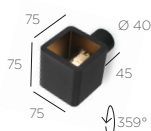

230V - G9 HALO I

CODE 2006

CODE 1006

CODE 7006 |

180€

12V - GY6.35 HALO I

CODE 2126

CODE 1126

CODE 7126 |

180€

230V - G9 LED I

CODE L2006

CODE L1006

CODE L7006 |

180€

◆ 230V - G9 - 1 x HALO QT14 max. 60W or 1 x G9 LED (max. Ø19, max. L 62mm)

◆ 12V - **transformer excluded** - GY6.35 - 1 x QT12 max. 50W

Bulb excluded - Wall - CE IP55 eco

OPTIONAL COVER FOR CODE W OUT



ACEX 2006

ACEX 1006

ACEX 7006 |

39€

CODE W LED OUT

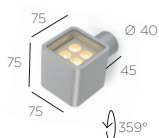

1 side I

COEX 211I ◆

COEX 111I ◆

COEX 711I ◆ |

378€

2 sides I

COEX 221I ◆

COEX 121I ◆

COEX 721I ◆ |

536€

350mA - **driver required (remote mounting) see below**

1 lighting side : 1 x 4 LED 0.96W - 350mA - 456lm - 2700K (on demand 6000K) - CRI >93 - **dimmable**

2 lighting sides : 2 x 4 LED 0.96W - 350mA - 2 x 456lm - 2700K (on demand 6000K) - CRI >93 - **dimmable**

◆ Choose beam: N=narrow 10° or M=medium 25° or W=wide 40°

LED included - Wall - CE IP55 eco

REQUIRED DRIVER (REMOTE MOUNTING)

DEVICE	DIM.	DRIVER	NET PRICE	DEVICE	DIM.	DRIVER	NET PRICE
1 x	1 side	NO	*** 7,90€	1 x	2 sides	NO	18,65€
		I-HO PU				D 12W**	
1-2 x	1 side	NO	*** 18,65€	1 x	1 side	LC	14,65€
		I-HO PU				D 10WT	
2 x	1 side	LC	*** 14,65€	2 x	1 side	DA	22,60€
		I-HO PU				D 15WP*	
1-3 x	1 side	DA	*** 20,65€	1-3 x	1 side	I-HO PU	22,60€
		I-HO PU				D 15WDA*	
2-8 x	1 side	I-HO PU	*** 44,65€	1-4 x	2 sides	I-HO PU	44,65€
		I-HO PU DA				D 40WP*	
		I-HO PU DA	46,65€			I-HO PU DA	46,65€

driver does not fit through cutout hole of fixture

*110V-230V **IP65

***driver fits behind optional cover for CODE W LED

For warranty use only Trizo21® supplied LED drivers as mentioned.

For all specs and techs about drivers, see www.trizo21.com/drivers

OPTIONAL COVER FOR CODE W LED OUT























ACEX 2006

ACEX 1006

ACEX 7006 |

39€

		 	 	
	CE standard	norme CE	CE norm	CE Standard
	fixture class 1	appareil classe 1	toestel klasse 1	Gerät Klasse 1
	fixture class 2	appareil classe 2	toestel klasse 2	Gerät Klasse 2
	fixture class 3	appareil classe 3	toestel klasse 3	Gerät Klasse 3
IP	protection level	indice de protection	beschermingsindicatie	Schutzklasse
	beam	rayon de lumière	lichtbundel	lichtbündel
	ecologic (LED)	ecologique (LED)	ecologisch (LED)	ökologisch (LED)
+B	with base	avec base	met basis	mit Sockel
D+B	driver with base	convertisseur avec base	voeding met basis	Konverter mit Sockel
	1 lighting side	1 face lumineuse	1 zijde verlicht	1 Seite Beleuchtung
	2 lighting sides	2 faces lumineuses	2 zijden verlicht	2 Seiten Beleuchtung
	adjustable	orientable	richtbaar	Schwenkbar
mm	dimensions in mm.	dimensions en mm.	afmetingen in mm.	Abmessungen in mm.
W/C	wall or ceiling	applique ou plafonnier	wand of plafond	Wand oder Decke
L	length	longueur	lengte	Länge
W	width	largeur	breedte	Breite
H	height	hauteur	hoogte	Höhe
	non-dimmable	non dimmable	niet-dimbaar	nicht dimmbar
	1-10V dimmable	1-10V dimmable	1-10V dimbaar	1-10V dimmbar
	PUSH-DIM dimmable	PUSH-DIM dimmable	PUSH-DIM dimbaar	PUSH-DIM dimmbar
	Dali dimmable	Dali dimmable	Dali dimbaar	Dali dimmbar
	TRIAC/IGBT dimmable	TRIAC/IGBT dimmable	TRIAC/IGBT dimbaar	TRIAC/IGBT dimmbar
	IGBT dimmable	IGBT dimmable	IGBT dimbaar	IGBT dimmbar
RS 16	short rod 160mm	tige courte 160mm	korte stang 160mm	kurze Stange 160mm
RL 79	large rod 790mm	tige longue 790mm	lange stang 790mm	lange Stange 790mm
RF 75	fixed rod 750 mm	tige fixe 750 mm	vaste stang 750 mm	feste Stange 750 mm
RF 100	fixed rod 1000 mm	tige fixe 1000 mm	vaste stang 1000 mm	feste Stange 1000 mm

Trizo21 | Kerrebroek 52 | B-9850 Deinze | Belgium

T +32 (0)9 380 43 43

E info@trizo21.com

W www.trizo21.com

W www.elements-configurator.trizo21.com

 [instagram.com/trizo21](https://www.instagram.com/trizo21)

 [facebook.com/trizo21](https://www.facebook.com/trizo21)

All models | Copyright © Trizo21 & Bruno Van Meenen

All products | Handmade in Belgium

Pricelist | 07.2020

retail prices in euro, VAT excl.

Important notice:

For warranty use only Trizo21® supplied LED drivers as mentioned.

No warranty when used without the supplied LED drivers!

All information in this pricelist is without engagement, replaces all preceding information and can always be modified.

Trizo21 bvba has the right to change the technical aspects of its products at any time without prior notice.

All our product carry the CE logo. The CE logo represents an implicit quality assurance.

For further technical information, please visit www.trizo21.com

All products are supplied without bulbs and/or drivers, unless stated otherwise.

All dimensions are expressed in mm.

No part of this book may be reproduced without written authorisation of Trizo21 bvba.