

<u>Alco</u>	01	<u>Florinda</u>	79	<u>Milleluci Soft</u>	142
<u>Angelica</u>	09	<u>Florinda Desnuda</u>	83	<u>Mood</u>	145
<u>Angelica Outdoor</u>	12	<u>Frisé</u>	87	<u>Multiball</u>	147
<u>Baobab</u>	13	<u>Galileo</u>	89	<u>Nucleo</u>	152
<u>Basilica</u>	15	<u>Galileo Longue</u>	92	<u>Ombrella</u>	155
<u>Bolla Ellisse</u>	17	<u>Geco</u>	94	<u>Orb</u>	158
<u>Butterfly</u>	20	<u>Gregory</u>	96	<u>Peggy</u>	166
<u>Campanone</u>	22	<u>Hammer</u>	101	<u>Rettangolo</u>	174
<u>Campanone Outdoor</u>	23	<u>Hoop</u>	106	<u>Reverse Basic</u>	178
<u>Chandelier</u>	24	<u>Icaro</u>	114	<u>Righello</u>	180
<u>Chandelier Longue</u>	29	<u>Icaro Outdoor</u>	116	<u>Ring</u>	181
<u>Cilindro</u>	33	<u>Icaro Ball</u>	118	<u>Ring Tonda</u>	183
<u>Circus</u>	43	<u>Icaro Ball Outdoor</u>	120	<u>Romeo</u>	186
<u>Clip</u>	50	<u>Idea</u>	122		
<u>Cocò</u>	52	<u>Loto</u>	127		
<u>Cocò Demi</u>	55	<u>Lucilla</u>	133		
<u>Discovolante</u>	59	<u>Milleluci</u>	137		

PRODUCTS: Alco
DESIGN: Roberto Paoli 2017

Large pendant or ceiling lamp certified in acoustic comfort. Semicircular elements covered by velvet, wool, For nature, Kvadrat, cubic and bubble fabric.
 Removable and easy care fabric cover.
 Bottom cap in thermoformed opal PMMA with soft touch finishing.

Symbol Index  → • / present - / absent OD / On Demand



ALCO

Pendant lamp - ø 90



42 cm 30 cm 200 cm
 16.53" 11.81" 78.74"

90 cm
 35.42"

DESCRIZIONE	SORGENTE			IP	CODICE	
Velvet NO DIM	1 led module 23 W - 3628 Lm - 2700 K	OD	OD	IP20	ALCESO090O01	3.550
Velvet DIM TRIAC	1 led module 23 W - 3628 Lm - 2700 K	OD	OD	IP20	ALCESO090O02	3.625
Velvet DIM DALI-Push DIM	1 led module 23 W - 3628 Lm - 2700 K	OD	OD	IP20	ALCESO090O03	3.625
Wool NO DIM	1 led module 23 W - 3628 Lm - 2700 K	OD	OD	IP20	ALCESO090E01	3.550
Wool DIM TRIAC	1 led module 23 W - 3628 Lm - 2700 K	OD	OD	IP20	ALCESO090E02	3.625
Wool DIM DALI-Push DIM	1 led module 23 W - 3628 Lm - 2700 K	OD	OD	IP20	ALCESO090E03	3.625
For nature NO DIM	1 led module 23 W - 3628 Lm - 2700 K	OD	OD	IP20	ALCESO090Q01	3.685
For nature DIM TRIAC	1 led module 23 W - 3628 Lm - 2700 K	OD	OD	IP20	ALCESO090Q02	3.760
For nature DIM DALI-Push DIM	1 led module 23 W - 3628 Lm - 2700 K	OD	OD	IP20	ALCESO090Q03	3.760
Kvadrat NO DIM	1 led module 23 W - 3628 Lm - 2700 K	OD	OD	IP20	ALCESO090I01	3.780
Kvadrat DIM TRIAC	1 led module 23 W - 3628 Lm - 2700 K	OD	OD	IP20	ALCESO090I02	3.855
Kvadrat DIM DALI-Push DIM	1 led module 23 W - 3628 Lm - 2700 K	OD	OD	IP20	ALCESO090I03	3.855
Cubic NO DIM	1 led module 23 W - 3628 Lm - 2700 K	OD	OD	IP20	ALCESO090A01	3.950
Cubic DIM TRIAC	1 led module 23 W - 3628 Lm - 2700 K	OD	OD	IP20	ALCESO090A02	4.020
Cubic DIM DALI-Push DIM	1 led module 23 W - 3628 Lm - 2700 K	OD	OD	IP20	ALCESO090A03	4.020
Bubble NO DIM	1 led module 23 W - 3628 Lm - 2700 K	OD	OD	IP20	ALCESO090S01	3.400
Bubble DIM TRIAC	1 led module 23 W - 3628 Lm - 2700 K	OD	OD	IP20	ALCESO090S02	3.475
Bubble DIM DALI-Push DIM	1 led module 23 W - 3628 Lm - 2700 K	OD	OD	IP20	ALCESO090S03	3.475

PRODUCTS: Alco
DESIGN: Roberto Paoli 2017

Large pendant or ceiling lamp certified in acoustic comfort. Semicircular elements covered by velvet, wool, For nature, Kvadrat, cubic and bubble fabric.
 Removable and easy care fabric cover.
 Bottom cap in thermoformed opal PMMA with soft touch finishing.

Symbol Index  → • / present - / absent OD / On Demand



ALCO

Pendant lamp - ø 90



90 cm
35.42"

42 cm 30 cm 200 cm
16.53" 11.81" 78.74"

DESCRIZIONE	SORGENTE			IP	CODICE	
Velvet NO DIM	1 led module 57 W - 8750 Lm - 2700 K	OD	OD	IP20	ALCESO090O04	3.655
Velvet DIM TRIAC	1 led module 57 W - 8750 Lm - 2700 K	OD	OD	IP20	ALCESO090O05	3.730
Velvet DIM DALI-Push DIM	1 led module 57 W - 8750 Lm - 2700 K	OD	OD	IP20	ALCESO090O06	3.730
Wool NO DIM	1 led module 57 W - 8750 Lm - 2700 K	OD	OD	IP20	ALCESO090E04	3.655
Wool DIM TRIAC	1 led module 57 W - 8750 Lm - 2700 K	OD	OD	IP20	ALCESO090E05	3.730
Wool DIM DALI-Push DIM	1 led module 57 W - 8750 Lm - 2700 K	OD	OD	IP20	ALCESO090E06	3.730
For nature NO DIM	1 led module 57 W - 8750 Lm - 2700 K	OD	OD	IP20	ALCESO090Q04	3.790
For nature DIM TRIAC	1 led module 57 W - 8750 Lm - 2700 K	OD	OD	IP20	ALCESO090Q05	3.865
For nature DIM DALI-Push DIM	1 led module 57 W - 8750 Lm - 2700 K	OD	OD	IP20	ALCESO090Q06	3.865
Kvadrat NO DIM	1 led module 57 W - 8750 Lm - 2700 K	OD	OD	IP20	ALCESO090I04	3.885
Kvadrat DIM TRIAC	1 led module 57 W - 8750 Lm - 2700 K	OD	OD	IP20	ALCESO090I05	3.960
Kvadrat DIM DALI-Push DIM	1 led module 57 W - 8750 Lm - 2700 K	OD	OD	IP20	ALCESO090I06	3.960
Cubic NO DIM	1 led module 57 W - 8750 Lm - 2700 K	OD	OD	IP20	ALCESO090A04	4.055
Cubic DIM TRIAC	1 led module 57 W - 8750 Lm - 2700 K	OD	OD	IP20	ALCESO090A05	4.125
Cubic DIM DALI-Push DIM	1 led module 57 W - 8750 Lm - 2700 K	OD	OD	IP20	ALCESO090A06	4.125
Bubble NO DIM	1 led module 57 W - 8750 Lm - 2700 K	OD	OD	IP20	ALCESO090S04	3.505
Bubble DIM TRIAC	1 led module 57 W - 8750 Lm - 2700 K	OD	OD	IP20	ALCESO090S05	3.580
Bubble DIM DALI-Push DIM	1 led module 57 W - 8750 Lm - 2700 K	OD	OD	IP20	ALCESO090S06	3.580

NOTE: on demand, LED modules are also available in 3000K and 4000K, without surcharge.

- 0

PRODUCTS: Alco
DESIGN: Roberto Paoli 2017

Large pendant or ceiling lamp certified in acoustic comfort. Semicircular elements covered by velvet, wool, For nature, Kvadrat, cubic and bubble fabric.
 Removable and easy care fabric cover.
 Bottom cap in thermoformed opal PMMA with soft touch finishing.

Symbol Index  → • / present - / adsent OD / On Demand



ALCO

Pendant lamp - ø 120



120 cm
47.24"

42 cm 30 cm 200 cm
16.53" 11.81" 78.74"

DESCRIZIONE	SORGENTE			IP	CODICE	
Velvet NO DIM	1 led module 23 W - 3628 Lm - 2700 K	OD	OD	IP20	ALCESO120O01	4.275
Velvet DIM TRIAC	1 led module 23 W - 3628 Lm - 2700 K	OD	OD	IP20	ALCESO120O02	4.345
Velvet DIM DALI-Push DIM	1 led module 23 W - 3628 Lm - 2700 K	OD	OD	IP20	ALCESO120O03	4.345
Wool NO DIM	1 led module 23 W - 3628 Lm - 2700 K	OD	OD	IP20	ALCESO120E01	4.275
Wool DIM TRIAC	1 led module 23 W - 3628 Lm - 2700 K	OD	OD	IP20	ALCESO120E02	4.345
Wool DIM DALI-Push DIM	1 led module 23 W - 3628 Lm - 2700 K	OD	OD	IP20	ALCESO120E03	4.345
For nature NO DIM	1 led module 23 W - 3628 Lm - 2700 K	OD	OD	IP20	ALCESO120Q01	4.450
For nature DIM TRIAC	1 led module 23 W - 3628 Lm - 2700 K	OD	OD	IP20	ALCESO120Q02	4.525
For nature DIM DALI-Push DIM	1 led module 23 W - 3628 Lm - 2700 K	OD	OD	IP20	ALCESO120Q03	4.525
Kvadrat NO DIM	1 led module 23 W - 3628 Lm - 2700 K	OD	OD	IP20	ALCESO120I01	4.675
Kvadrat DIM TRIAC	1 led module 23 W - 3628 Lm - 2700 K	OD	OD	IP20	ALCESO120I02	4.745
Kvadrat DIM DALI-Push DIM	1 led module 23 W - 3628 Lm - 2700 K	OD	OD	IP20	ALCESO120I03	4.745
Cubic NO DIM	1 led module 23 W - 3628 Lm - 2700 K	OD	OD	IP20	ALCESO120A01	4.780
Cubic DIM TRIAC	1 led module 23 W - 3628 Lm - 2700 K	OD	OD	IP20	ALCESO120A02	4.850
Cubic DIM DALI-Push DIM	1 led module 23 W - 3628 Lm - 2700 K	OD	OD	IP20	ALCESO120A03	4.850
Bubble NO DIM	1 led module 23 W - 3628 Lm - 2700 K	OD	OD	IP20	ALCESO120S01	4.085
Bubble DIM TRIAC	1 led module 23 W - 3628 Lm - 2700 K	OD	OD	IP20	ALCESO120S02	4.160
Bubble DIM DALI-Push DIM	1 led module 23 W - 3628 Lm - 2700 K	OD	OD	IP20	ALCESO120S03	4.160

PRODUCTS: Alco
DESIGN: Roberto Paoli 2017



Large pendant or ceiling lamp certified in acoustic comfort. Semicircular elements covered by velvet, wool, For nature, Kvadrat, cubic and bubble fabric.
 Removable and easy care fabric cover.
 Bottom cap in thermoformed opal PMMA with soft touch finishing.

Symbol Index  → • / present - / adsent OD / On Demand

ALCO

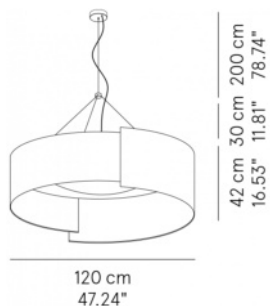
Pendant lamp - ø 120



DESCRIZIONE	SORGENTE			IP	CODICE	
Velvet NO DIM	1 led module 57 W - 8750 Lm - 2700 K	OD	OD	IP20	ALCESO120O06	4.380
Velvet DIM TRIAC	1 led module 57 W - 8750 Lm - 2700 K	OD	OD	IP20	ALCESO120O07	4.450
Velvet DIM DALI - Push DIM	1 led module 57 W - 8750 Lm - 2700 K	OD	OD	IP20	ALCESO120O08	4.450
Wool NO DIM	1 led module 57 W - 8750 Lm - 2700 K	OD	OD	IP20	ALCESO120E06	4.380
Wool DIM TRIAC	1 led module 57 W - 8750 Lm - 2700 K	OD	OD	IP20	ALCESO120E07	4.450
Wool DIM DALI - Push DIM	1 led module 57 W - 8750 Lm - 2700 K	OD	OD	IP20	ALCESO120E08	4.450
For nature NO DIM	1 led module 57 W - 8750 Lm - 2700 K	OD	OD	IP20	ALCESO120Q06	4.555
For nature DIM TRIAC	1 led module 57 W - 8750 Lm - 2700 K	OD	OD	IP20	ALCESO120Q07	4.630
For nature DIM DALI - Push DIM	1 led module 57 W - 8750 Lm - 2700 K	OD	OD	IP20	ALCESO120Q08	4.630
Kvadrat NO DIM	1 led module 57 W - 8750 Lm - 2700 K	OD	OD	IP20	ALCESO120I06	4.780
Kvadrat DIM TRIAC	1 led module 57 W - 8750 Lm - 2700 K	OD	OD	IP20	ALCESO120I07	4.850
Kvadrat DIM DALI - Push DIM	1 led module 57 W - 8750 Lm - 2700 K	OD	OD	IP20	ALCESO120I08	4.850
Cubic NO DIM	1 led module 57 W - 8750 Lm - 2700 K	OD	OD	IP20	ALCESO120A06	4.885
Cubic DIM TRIAC	1 led module 57 W - 8750 Lm - 2700 K	OD	OD	IP20	ALCESO120A07	4.955
Cubic DIM DALI-Push DIM	1 led module 57 W - 8750 Lm - 2700 K	OD	OD	IP20	ALCESO120A08	4.955
Bubble NO DIM	1 led module 57 W - 8750 Lm - 2700 K	OD	OD	IP20	ALCESO120S06	4.190
Bubble DIM TRIAC	1 led module 57 W - 8750 Lm - 2700 K	OD	OD	IP20	ALCESO120S07	4.265
Bubble DIM DALI-Push DIM	1 led module 57 W - 8750 Lm - 2700 K	OD	OD	IP20	ALCESO120S08	4.265

NOTE: on demand, LED modules are also available in 3000K and 4000K, without surcharge.

PRODUCTS: Alco
DESIGN: Roberto Paoli 2017

Large pendant or ceiling lamp certified in acoustic comfort. Semicircular elements covered by velvet, wool, For nature, Kvadrat, cubic and bubble fabric.
 Removable and easy care fabric cover.
 Bottom cap in thermoformed opal PMMA with soft touch finishing.

Symbol Index  → • / present - / absent OD / On Demand

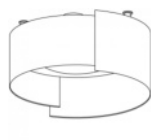

ALCO

Ceiling lamp - ø 90



90 cm
35.42"

48 cm
18.9"

DESCRIZIONE	SORGENTE			IP	CODICE	
Velvet NO DIM	1 led module 23 W - 3628 Lm - 2700 K	OD	OD	IP20	ALCEPL090O01	3.865
Velvet DIM TRIAC	1 led module 23 W - 3628 Lm - 2700 K	OD	OD	IP20	ALCEPL090O02	3.940
Velvet DIM DALI-Push DIM	1 led module 23 W - 3628 Lm - 2700 K	OD	OD	IP20	ALCEPL090O03	3.940
Wool NO DIM	1 led module 23 W - 3628 Lm - 2700 K	OD	OD	IP20	ALCEPL090E01	3.865
Wool DIM TRIAC	1 led module 23 W - 3628 Lm - 2700 K	OD	OD	IP20	ALCEPL090E02	3.940
Wool DIM DALI-Push DIM	1 led module 23 W - 3628 Lm - 2700 K	OD	OD	IP20	ALCEPL090E03	3.940
For nature NO DIM	1 led module 23 W - 3628 Lm - 2700 K	OD	OD	IP20	ALCEPL090Q01	4.000
For nature DIM TRIAC	1 led module 23 W - 3628 Lm - 2700 K	OD	OD	IP20	ALCEPL090Q02	4.075
For nature DIM DALI-Push DIM	1 led module 23 W - 3628 Lm - 2700 K	OD	OD	IP20	ALCEPL090Q03	4.075
Kvadrat NO DIM	1 led module 23 W - 3628 Lm - 2700 K	OD	OD	IP20	ALCEPL090I01	4.095
Kvadrat DIM TRIAC	1 led module 23 W - 3628 Lm - 2700 K	OD	OD	IP20	ALCEPL090I02	4.170
Kvadrat DIM DALI-Push DIM	1 led module 23 W - 3628 Lm - 2700 K	OD	OD	IP20	ALCEPL090I03	4.170
Cubic NO DIM	1 led module 23 W - 3628 Lm - 2700 K	OD	OD	IP20	ALCEPL090A01	4.265
Cubic DIM TRIAC	1 led module 23 W - 3628 Lm - 2700 K	OD	OD	IP20	ALCEPL090A02	4.335
Cubic DIM DALI-Push DIM	1 led module 23 W - 3628 Lm - 2700 K	OD	OD	IP20	ALCEPL090A03	4.335
Bubble NO DIM	1 led module 23 W - 3628 Lm - 2700 K	OD	OD	IP20	ALCEPL090S01	3.715
Bubble DIM TRIAC	1 led module 23 W - 3628 Lm - 2700 K	OD	OD	IP20	ALCEPL090S02	3.790
Bubble DIM DALI-Push DIM	1 led module 23 W - 3628 Lm - 2700 K	OD	OD	IP20	ALCEPL090S03	3.790

PRODUCTS: Alco
DESIGN: Roberto Paoli 2017

Large pendant or ceiling lamp certified in acoustic comfort. Semicircular elements covered by velvet, wool, For nature, Kvadrat, cubic and bubble fabric.
 Removable and easy care fabric cover.
 Bottom cap in thermoformed opal PMMA with soft touch finishing.

Symbol Index  → • / present - / absent OD / On Demand

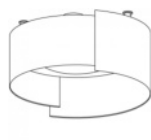

ALCO

Ceiling lamp - ø 90



48 cm
18.9"

90 cm
35.42"

DESCRIZIONE	SORGENTE			IP	CODICE	
Velvet NO DIM	1 led module 57 W - 8750 Lm - 2700 K	OD	OD	IP20	ALCEPL090O04	3.970
Velvet DIM TRIAC	1 led module 57 W - 8750 Lm - 2700 K	OD	OD	IP20	ALCEPL090O05	4.045
Velvet DIM DALI-Push DIM	1 led module 57 W - 8750 Lm - 2700 K	OD	OD	IP20	ALCEPL090O06	4.045
Wool NO DIM	1 led module 57 W - 8750 Lm - 2700 K	OD	OD	IP20	ALCEPL090E04	3.970
Wool DIM TRIAC	1 led module 57 W - 8750 Lm - 2700 K	OD	OD	IP20	ALCEPL090E05	4.045
Wool DIM DALI-Push DIM	1 led module 57 W - 8750 Lm - 2700 K	OD	OD	IP20	ALCEPL090E06	4.045
For nature NO DIM	1 led module 57 W - 8750 Lm - 2700 K	OD	OD	IP20	ALCEPL090Q04	4.105
For nature DIM TRIAC	1 led module 57 W - 8750 Lm - 2700 K	OD	OD	IP20	ALCEPL090Q05	4.180
For nature DIM DALI-Push DIM	1 led module 57 W - 8750 Lm - 2700 K	OD	OD	IP20	ALCEPL090Q06	4.180
Kvadrat NO DIM	1 led module 57 W - 8750 Lm - 2700 K	OD	OD	IP20	ALCEPL090I04	4.200
Kvadrat DIM TRIAC	1 led module 57 W - 8750 Lm - 2700 K	OD	OD	IP20	ALCEPL090I05	4.275
Kvadrat DIM DALI-Push DIM	1 led module 57 W - 8750 Lm - 2700 K	OD	OD	IP20	ALCEPL090I06	4.275
Cubic NO DIM	1 led module 57 W - 8750 Lm - 2700 K	OD	OD	IP20	ALCEPL090A04	4.370
Cubic DIM TRIAC	1 led module 57 W - 8750 Lm - 2700 K	OD	OD	IP20	ALCEPL090A05	4.440
Cubic DIM DALI-Push DIM	1 led module 57 W - 8750 Lm - 2700 K	OD	OD	IP20	ALCEPL090A06	4.440
Bubble NO DIM	1 led module 57 W - 8750 Lm - 2700 K	OD	OD	IP20	ALCEPL090S04	3.820
Bubble DIM TRIAC	1 led module 57 W - 8750 Lm - 2700 K	OD	OD	IP20	ALCEPL090S05	3.895
Bubble DIM DALI-Push DIM	1 led module 57 W - 8750 Lm - 2700 K	OD	OD	IP20	ALCEPL090S06	3.895

NOTE: on demand, LED modules are also available in 3000K and 4000K, without surcharge.

-

0

PRODUCTS: Alco
DESIGN: Roberto Paoli 2017



Large pendant or ceiling lamp certified in acoustic comfort. Semicircular elements covered by velvet, wool, For nature, Kvadrat, cubic and bubble fabric.
 Removable and easy care fabric cover.
 Bottom cap in thermoformed opal PMMA with soft touch finishing.

Symbol Index  → • / present - / absent OD / On Demand

ALCO

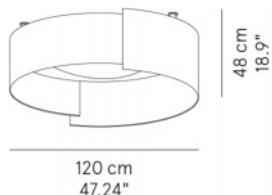
Ceiling lamp - ø 120



DESCRIZIONE	SORGENTE			IP	CODICE	
Velvet NO DIM	1 led module 23 W - 3628 Lm - 2700 K	OD	OD	IP20	ALCEPL120O01	4.580
Velvet DIM TRIAC	1 led module 23 W - 3628 Lm - 2700 K	OD	OD	IP20	ALCEPL120O02	4.650
Velvet DIM DALI-Push DIM	1 led module 23 W - 3628 Lm - 2700 K	OD	OD	IP20	ALCEPL120O03	4.650
Wool NO DIM	1 led module 23 W - 3628 Lm - 2700 K	OD	OD	IP20	ALCEPL120E01	4.580
Wool DIM TRIAC	1 led module 23 W - 3628 Lm - 2700 K	OD	OD	IP20	ALCEPL120E02	4.650
Wool DIM DALI-Push DIM	1 led module 23 W - 3628 Lm - 2700 K	OD	OD	IP20	ALCEPL120E03	4.650
For nature NO DIM	1 led module 23 W - 3628 Lm - 2700 K	OD	OD	IP20	ALCEPL120Q01	4.755
For nature DIM TRIAC	1 led module 23 W - 3628 Lm - 2700 K	OD	OD	IP20	ALCEPL120Q02	4.830
For nature DIM DALI-Push DIM	1 led module 23 W - 3628 Lm - 2700 K	OD	OD	IP20	ALCEPL120Q03	4.830
Kvadrat NO DIM	1 led module 23 W - 3628 Lm - 2700 K	OD	OD	IP20	ALCEPL120I01	4.925
Kvadrat DIM TRIAC	1 led module 23 W - 3628 Lm - 2700 K	OD	OD	IP20	ALCEPL120I02	5.000
Kvadrat DIM DALI-Push DIM	1 led module 23 W - 3628 Lm - 2700 K	OD	OD	IP20	ALCEPL120I03	5.000
Cubic NO DIM	1 led module 23 W - 3628 Lm - 2700 K	OD	OD	IP20	ALCEPL120A01	5.080
Cubic DIM TRIAC	1 led module 23 W - 3628 Lm - 2700 K	OD	OD	IP20	ALCEPL120A02	5.155
Cubic DIM DALI-Push DIM	1 led module 23 W - 3628 Lm - 2700 K	OD	OD	IP20	ALCEPL120A03	5.155
Bubble NO DIM	1 led module 23 W - 3628 Lm - 2700 K	OD	OD	IP20	ALCEPL120S01	4.390
Bubble DIM TRIAC	1 led module 23 W - 3628 Lm - 2700 K	OD	OD	IP20	ALCEPL120S02	4.465
Bubble DIM DALI-Push DIM	1 led module 23 W - 3628 Lm - 2700 K	OD	OD	IP20	ALCEPL120S03	4.465

PRODUCTS: Alco
DESIGN: Roberto Paoli 2017



Large pendant or ceiling lamp certified in acoustic comfort. Semicircular elements covered by velvet, wool, For nature, Kvadrat, cubic and bubble fabric.
 Removable and easy care fabric cover.
 Bottom cap in thermoformed opal PMMA with soft touch finishing.

Symbol Index  → • / present - / adsent OD / On Demand

ALCO

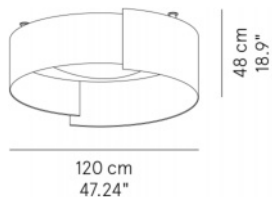
Ceiling lamp - ø 120



DESCRIZIONE	SORGENTE			IP	CODICE	
Velvet NO DIM	1 led module 57 W - 8750 Lm - 2700 K	OD	OD	IP20	ALCEPL120O06	4.525
Velvet DIM TRIAC	1 led module 57 W - 8750 Lm - 2700 K	OD	OD	IP20	ALCEPL120O07	4.600
Velvet DIM DALI - Push DIM	1 led module 57 W - 8750 Lm - 2700 K	OD	OD	IP20	ALCEPL120O08	4.600
Wool NO DIM	1 led module 57 W - 8750 Lm - 2700 K	OD	OD	IP20	ALCEPL120E06	4.525
Wool DIM TRIAC	1 led module 57 W - 8750 Lm - 2700 K	OD	OD	IP20	ALCEPL120E07	4.600
Wool DIM DALI - Push DIM	1 led module 57 W - 8750 Lm - 2700 K	OD	OD	IP20	ALCEPL120E08	4.600
For nature NO DIM	1 led module 57 W - 8750 Lm - 2700 K	OD	OD	IP20	ALCEPL120Q06	4.705
For nature DIM TRIAC	1 led module 57 W - 8750 Lm - 2700 K	OD	OD	IP20	ALCEPL120Q07	4.780
For nature DIM DALI - Push DIM	1 led module 57 W - 8750 Lm - 2700 K	OD	OD	IP20	ALCEPL120Q08	4.780
Kvadrat NO DIM	1 led module 57 W - 8750 Lm - 2700 K	OD	OD	IP20	ALCEPL120I06	4.870
Kvadrat DIM TRIAC	1 led module 57 W - 8750 Lm - 2700 K	OD	OD	IP20	ALCEPL120I07	4.945
Kvadrat DIM DALI-Push DIM	1 led module 57 W - 8750 Lm - 2700 K	OD	OD	IP20	ALCEPL120I08	4.945
Cubic NO DIM	1 led module 57 W - 8750 Lm - 2700 K	OD	OD	IP20	ALCEPL120A06	5.030
Cubic DIM TRIAC	1 led module 57 W - 8750 Lm - 2700 K	OD	OD	IP20	ALCEPL120A07	5.105
Cubic DIM DALI-Push DIM	1 led module 57 W - 8750 Lm - 2700 K	OD	OD	IP20	ALCEPL120A08	5.105
Bubble NO DIM	1 led module 57 W - 8750 Lm - 2700 K	OD	OD	IP20	ALCEPL120S06	4.335
Bubble DIM TRIAC	1 led module 57 W - 8750 Lm - 2700 K	OD	OD	IP20	ALCEPL120S07	4.410
Bubble DIM DALI-Push DIM	1 led module 57 W - 8750 Lm - 2700 K	OD	OD	IP20	ALCEPL120S08	4.410

NOTE: on demand, LED modules are also available in 3000K and 4000K, without surcharge.

- 0

PRODUCTS: Angelica

DESIGN: design: Paolo Grasselli + Moduluze R&D 2011



Floor lamp with cantilever arm (adjustable in two positions) and wall lamp (on the axis 160° rotating). Embossed white or black painted aluminium structure. Lampshade available in cotton fabric in the same colour as the metal structure, in washable marble, wool sand fabric or Kvadrat ecrù. On demand, cotton, washable, wool and Kvadrat fabric lampshade available in different colours with a 3% surcharge.

Symbol Index  → • / present - / adsent OD / On Demand

ANGELICA

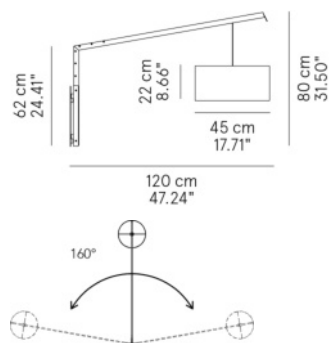
Wall lamp - L 120



DESCRIZIONE	SORGENTE			IP	CODICE	
Wall lamp L.120 white cotton white	1xE27max watt 70 W HES	OD	OD	IP20	ANGEAP135C01	940
Wall lamp L.120 black cotton black	1xE27max watt 70 W HES	OD	OD	IP20	ANGEAP135C02	940
Wall lamp L.120 white washable marble	1xE27max watt 70 W HES	OD	OD	IP20	ANGEAP135T01	1.020
Wall lamp L.120 black washable marble	1xE27max watt 70 W HES	OD	OD	IP20	ANGEAP135T02	1.020
Wall lamp L.120 white wool sand	1xE27max watt 70 W HES	•	OD	IP20	ANGEAP135E01	1.030
Wall lamp L.120 black wool sand	1xE27max watt 70 W HES	•	OD	IP20	ANGEAP135E02	1.030
Wall lamp L.120 white Kvadrat ecrù	1xE27max watt 70 W HES	•	OD	IP20	ANGEAP135I01	1.070
Wall lamp L.120 black Kvadrat ecrù	1xE27max watt 70 W HES	•	OD	IP20	ANGEAP135I02	1.070

Wall lamp - L 170

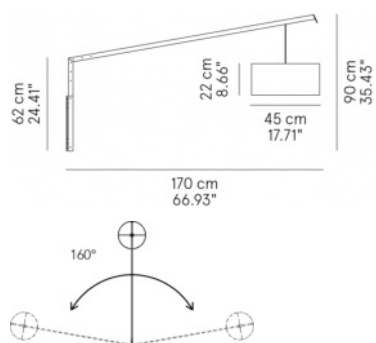

Wall lamp L.170 white cotton white	1xE27max watt 70 W HES	OD	OD	IP20	ANGEAP180C01	960
Wall lamp L.170 black cotton black	1xE27max watt 70 W HES	OD	OD	IP20	ANGEAP180C02	960
Wall lamp L.170 white washable marble	1xE27max watt 70 W HES	OD	OD	IP20	ANGEAP180T01	1.040
Wall lamp L.170 black washable marble	1xE27max watt 70 W HES	OD	OD	IP20	ANGEAP180T02	1.040
Wall lamp L.170 black wool sand	1xE27max watt 70 W HES	•	OD	IP20	ANGEAP180E02	1.050
Wall lamp L.170 white wool sand	1xE27max watt 70 W HES	•	OD	IP20	ANGEAP180E01	1.050
Wall lamp L.170 white Kvadrat ecrù	1xE27max watt 70 W HES	•	OD	IP20	ANGEAP180I01	1.090
Wall lamp L.170 black Kvadrat ecrù	1xE27max watt 70 W HES	•	OD	IP20	ANGEAP180I02	1.090

PRODUCTS: Angelica

DESIGN: design: Paolo Grasselli + Moduluze R&D 2011



Floor lamp with cantilever arm (adjustable in two positions) and wall lamp (on the axis 160° rotating). Embossed white or black painted aluminium structure. Lampshade available in cotton fabric in the same colour as the metal structure, in washable marble, wool sand fabric or Kvadrat ecrù. On demand, cotton, washable, wool and Kvadrat fabric lampshade available in different colours with a 3% surcharge.

Symbol Index  → • / present - / adsent OD / On Demand

ANGELICA

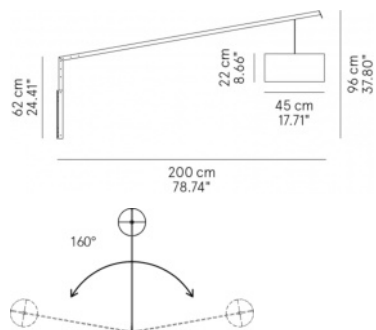
Wall lamp - L 200



DESCRIZIONE	SORGENTE			IP	CODICE	
Wall lamp L.200 white cotton white	1xE27max watt 70 W HES	OD	OD	IP20	ANGEAP200C01	1.005
Wall lamp L.200 black cotton black	1xE27max watt 70 W HES	OD	OD	IP20	ANGEAP200C02	1.005
Wall lamp L.200 white washable marble	1xE27max watt 70 W HES	OD	OD	IP20	ANGEAP200T01	1.080
Wall lamp L.200 black washable marble	1xE27max watt 70 W HES	OD	OD	IP20	ANGEAP200T02	1.080
Wall lamp L.200 white wool sand	1xE27max watt 70 W HES	•	OD	IP20	ANGEAP200E01	1.090
Wall lamp L.200 black wool sand	1xE27max watt 70 W HES	•	OD	IP20	ANGEAP200E02	1.090
Wall lamp L.200 white Kvadrat ecrù	1xE27max watt 70 W HES	•	OD	IP20	ANGEAP200I01	1.135
Wall lamp L.200 black Kvadrat ecrù	1xE27max watt 70 W HES	•	OD	IP20	ANGEAP200I02	1.135
Accessory - Wall lamp	Universal DIM switch HES (40/160W) + LED (4/100W)				DIMVAR0TA002	110



Accessory - Wall lamp

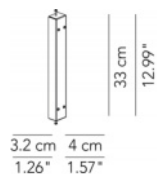

White fixing accessory for wall lamp	•	OD	IP20	DEJEAR000G01	130
Black fixing accessory for wall lamp	•	OD	IP20	DEJEAR000G02	130

PRODUCTS: Angelica

DESIGN: design: Paolo Grasselli + Moduluze R&D 2011



Floor lamp with cantilever arm (adjustable in two positions) and wall lamp (on the axis 160° rotating). Embossed white or black painted aluminium structure. Lampshade available in cotton fabric in the same colour as the metal structure, in washable marble, wool sand fabric or Kvadrat ecrù. On demand, cotton, washable, wool and Kvadrat fabric lampshade available in different colours with a 3% surcharge.

Symbol Index  → • / present - / adsent OD / On Demand

ANGELICA

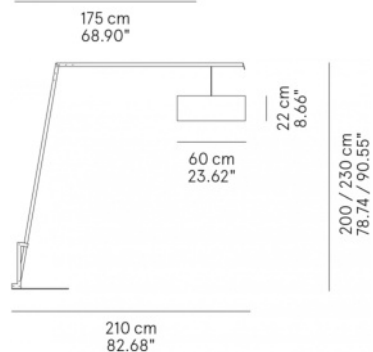
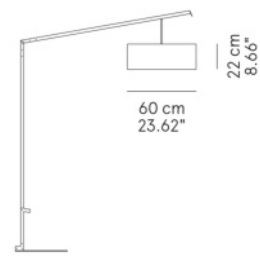
Floor lamp



DESCRIZIONE	SORGENTE			IP	CODICE	
Floor lamp white cotton white	1xE27max watt 70 W HES	OD	OD	IP20	ANGEPT230C01	1.530
Floor lamp black cotton black	1xE27max watt 70 W HES	OD	OD	IP20	ANGEPT230C02	1.530
Floor lamp white washable marble	1xE27max watt 70 W HES	OD	OD	IP20	ANGEPT230T01	1.630
Floor lamp black washable marble	1xE27max watt 70 W HES	OD	OD	IP20	ANGEPT230T02	1.630
Floor lamp white wool sand	1xE27max watt 70 W HES	•	OD	IP20	ANGEPT230E01	1.650
Floor lamp black wool sand	1xE27max watt 70 W HES	•	OD	IP20	ANGEPT230E02	1.650
Floor lamp white Kvadrat ecrù	1xE27max watt 70 W HES	•	OD	IP20	ANGEPT230I01	1.700
Floor lamp black Kvadrat ecrù	1xE27max watt 70 W HES	•	OD	IP20	ANGEPT230I02	1.700
Accessory - Floor lamp	Universal DIM switch HES + LED (5/250W)				DIMVAROPT003	130



PRODUCTS: Angelica Outdoor

DESIGN: design: Paolo Grasselli + Modoluce R&D 2018

Wall lamp with cantilever arm (on the axis 140° rotating). Embossed white or black painted aluminium structure.

Metal parts are protected with electrolytic galvanizing treatment and resistant polyester coating. Lampshade in washable marble fabric.

On demand, washable fabric lampshade available in different colours with 3% surcharge.

Symbol Index  → • / present - / absent OD / On Demand

ANGELICA OUTDOOR DESCRIZIONE

SORGENTE

  **IP** CODICE

Wall lamp - L 170

Wall lamp L.170 white washable marble

1xE27max watt 42 W HES

OD - IP44/55 AGOEAR170T01 1.840

Wall lamp L.170 black washable marble

1xE27max watt 42 W HES

OD - IP44/55 AGOEAR170T02 1.840

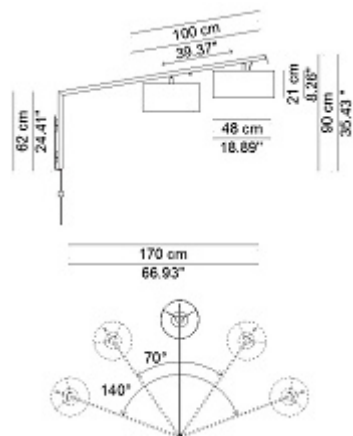

Accessory - Wall lamp

White fixing accessory for wall lamp

• - IP55 DEOEAR000G01 165



Black fixing accessory for wall lamp

• - IP55 DEOEAR000G02 165



PRODUCTS: Baobab
DESIGN: Paolo Grasselli 2017

Pendant and floor lamp with six arms.
 Metal structure painted in white, lead grey or bronze and in Deluxe finishing matt gold.
 Pendant lamp with counterbalance in natural brass, floor lamp with natural concrete base.

Symbol Index   → • / present - / adsent OD / On Demand

BAOBAB

DESCRIZIONE

SORGENTE



IP

CODICE

Pendant lamp 6 arms

Pendant lamp 6 arms white, lead grey or bronze

6xE27max watt 42 W HES

•	OD	IP20	BAOESO006G01	1.465
---	----	------	--------------	-------

Pendant lamp 6 arms Deluxe

6xE27max watt 42 W HES

•	OD	IP20	BAOESO006G02	1.680
---	----	------	--------------	-------

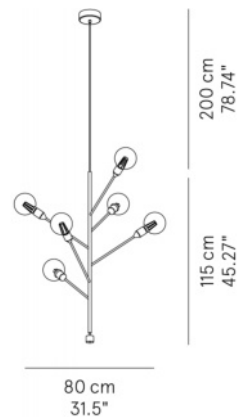

Kit 6 x light bulbs E27 Globe 125 LED 9W 2700K (NO DIM)

			LMPLEDE27KIT601	250
--	--	--	-----------------	-----

Kit 6 x light bulbs E27 Globe 125 LED 7W 2200K (DIM)

			LMPLEDE27KIT600	295
--	--	--	-----------------	-----

PRODUCTS: Baobab
DESIGN: Paolo Grasselli 2017

Pendant and floor lamp with six arms.
 Metal structure painted in white, lead grey or bronze and in Deluxe finishing matt gold.
 Pendant lamp with counterbalance in natural brass, floor lamp with natural concrete base.

Symbol Index  → • / present - / adsent OD / On Demand

BAOBAB

Floor lamp 6 arms



200 cm
78.74"

16 cm
6.29"

80 cm
31.5"

DESCRIZIONE

SORGENTE



IP

CODICE

Floor lamp white, lead grey or bronze

6xE27max watt 42 W HES

• OD IP20 BAOEPT200G01 1.715

Floor lamp Deluxe

6xE27max watt 42 W HES

• OD IP20 BAOEPT200G02 1.965

Kit 6 x light bulbs E27 Globe 125 LED 9W 2700K (NO DIM)

LMPLEDE27KIT601 250

Kit 6 x light bulbs E27 Globe 125 LED 7W 2200K (DIM)

LMPLEDE27KIT600 295

Accessory - Floor lamp

Universal DIM switch HES + LED (5/250W)

DIMVAROPT003 130



PRODUCTS: Basilica

DESIGN: design: Baldessari e Baldessari 2023

Pendant lamp with double light emission, lampshade available in velvet, wool and For nature fabrics.

Lamp with acoustic comfort features.



Double light emission - Basilica: Up 2690 Lm - Down 5380 Lm / Basilica Ball: depending on the light bulbs used.

Symbol Index  → • / present - / adsent OD / On Demand

BASILICA

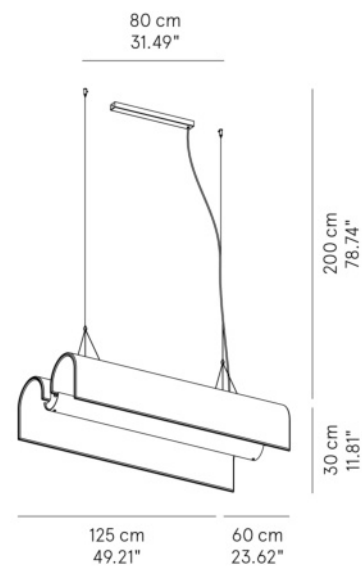
Pendant lamp - L 125



DESCRIZIONE	SORGENTE			IP	CODICE	
Velvet NO DIM	2 linear modules 48 W - 8070 Lm - 3000 K	•	OD	IP20	BASESO125O01	3.550
Velvet DIM DALI-Push DIM	2 linear modules 48 W - 8070 Lm - 3000 K	•	OD	IP20	BASESO125O02	3.660
Wool NO DIM	2 linear modules 48 W - 8070 Lm - 3000 K	•	OD	IP20	BASESO125E01	3.820
Wool DIM DALI-Push DIM	2 linear modules 48 W - 8070 Lm - 3000 K	•	OD	IP20	BASESO125E02	3.930
For nature NO DIM	2 linear modules 48 W - 8070 Lm - 3000 K	•	OD	IP20	BASESO125Q01	4.095
For nature DIM DALI-Push DIM	2 linear modules 48 W - 8070 Lm - 3000 K	•	OD	IP20	BASESO125Q02	4.205

PRODUCTS: Basilica

DESIGN: design: Baldessari e Baldessari 2023

Pendant lamp with double light emission, lampshade available in velvet, wool and For nature fabrics.

Lamp with acoustic comfort features.

Double light emission - Basilica: Up 2690 Lm - Down 5380 Lm / Basilica Ball: depending on the light bulbs used.

Symbol Index  → • / present - / adsent OD / On Demand

BASILICA

Basilica Ball - L 125

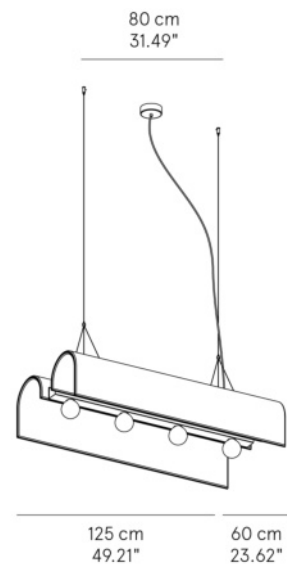

DESCRIZIONE

Velvet

Wool

For nature

SORGENTE

4xE27 + 2xGU10max watt 4 X 42W HES + 2 X 42W HES

4xE27 + 2xGU10max watt 4 X 42W HES + 2 X 42W HES

4xE27 + 2xGU10max watt 4 X 42W HES + 2 X 42W HES

Kit light bulbs: 4xE27 Globe 125 LED 11W 2700K (DIM) + 2xGU10 dichroic LED 7W 2700K (DIM)



IP

CODICE

• OD IP20 BABESO125O01 2.680

• OD IP20 BABESO125E01 2.950

• OD IP20 BABESO125Q01 3.225

LMPLEDE27KIT006 190

PRODUCTS: Bolla Ellisse

DESIGN: design: Paolo Grasselli + Modoluce R&D 2008

Pendant lamp in transparent PMMA. Inner diffuser available in cotton, Kvadrat or in hand-finished pleated and pleated ribbon fabric.



On demand, lampshade available in washable or wool fabrics (with surcharge).

Symbol Index  → • / present - / absent OD / On Demand

BOLLA ELLISSE

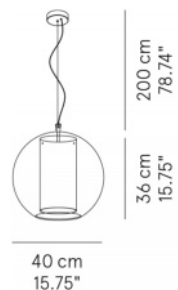
Pendant lamp - ø 40



DESCRIZIONE	SORGENTE			IP	CODICE	
Cotton	1xE27max watt 42 W HES	OD	OD	IP20	BOLES0040C01	600
Kvadrat	1xE27max watt 42 W HES	OD	OD	IP20	BOLES0040I01	635
Pleated fabric	1xE27max watt 42 W HES	OD	OD	IP20	BOLES0040P01	655
Pleated ribbon fabric	1xE27max watt 42 W HES	OD	OD	IP20	BOLES0040R01	660

Pendant lamp - ø 50

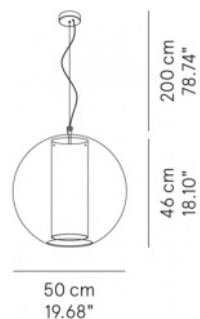



Cotton	1xE27max watt 42 W HES	OD	OD	IP20	BOLES0050C01	710
Kvadrat	1xE27max watt 42 W HES	OD	OD	IP20	BOLES0050I01	755
Pleated fabric	1xE27max watt 42 W HES	OD	OD	IP20	BOLES0050P01	790
Pleated ribbon fabric	1xE27max watt 42 W HES	OD	OD	IP20	BOLES0050R01	800

PRODUCTS: Bolla Ellisse

DESIGN: design: Paolo Grasselli + Modoluce R&D 2008

Pendant lamp in transparent PMMA. Inner diffuser available in cotton, Kvadrat or in hand-finished pleated and pleated ribbon fabric.



On demand, lampshade available in washable or wool fabrics (with surcharge).

Symbol Index   → • / present - / absent OD / On Demand

BOLLA ELLISSE

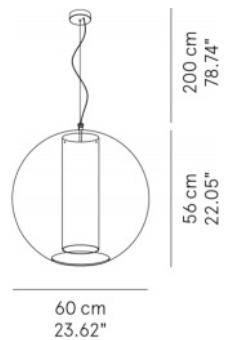
Pendant lamp - ø 60



DESCRIZIONE	SORGENTE			IP	CODICE	
Cotton	1xE27max watt 42 W HES	OD	OD	IP20	BOLESO060C01	870
Kvadrat	1xE27max watt 42 W HES	OD	OD	IP20	BOLESO060I01	940
Pleated fabric	1xE27max watt 42 W HES	OD	OD	IP20	BOLESO060P01	960
Pleated ribbon fabric	1xE27max watt 42 W HES	OD	OD	IP20	BOLESO060R01	975

Pendant lamp - ø 60

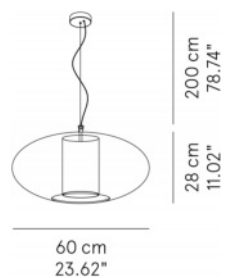



Cotton	1xE27max watt 42 W HES	-	OD	IP20	ELLESO060C01	740
Kvadrat	1xE27max watt 42 W HES	-	OD	IP20	ELLESO060I01	775
Pleated fabric	1xE27max watt 42 W HES	-	OD	IP20	ELLESO060P01	765
Pleated ribbon fabric	1xE27max watt 42 W HES	-	OD	IP20	ELLESO060R01	775

PRODUCTS: Bolla Ellisse

DESIGN: design: Paolo Grasselli + Modoluce R&D 2008

Pendant lamp in transparent PMMA. Inner diffuser available in cotton, Kvadrat or in hand-finished pleated and pleated ribbon fabric.

On demand, lampshade available in washable or wool fabrics (with surcharge).

Symbol Index   → • / present - / absent OD / On Demand

BOLLA ELLISSE

Pendant lamp - ø 80

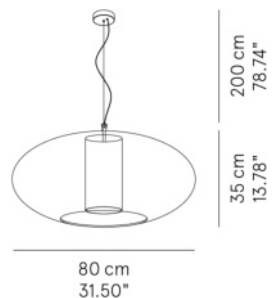

DESCRIZIONE

SORGENTE



IP

CODICE

Cotton

1xE27max watt 42 W HES

- OD IP20 ELLESO080C01 1.030

Kvadrat

1xE27max watt 42 W HES

- OD IP20 ELLESO080I01 1.070

Pleated fabric

1xE27max watt 42 W HES

- OD IP20 ELLESO080P01 1.105

Pleated ribbon fabric

1xE27max watt 42 W HES

- OD IP20 ELLESO080R01 1.115

PRODUCTS: Butterfly

DESIGN: design: Romano + Menegon 2021

Metal wall lamp painted in white, lead grey or bronze and in Deluxe finishing matt gold or available in the version with half discs covered in wool fabric with acoustic comfort features.

Symbol Index  → • / present - / adsent OD / On Demand

BUTTERFLY

Wall lamp - ø 54

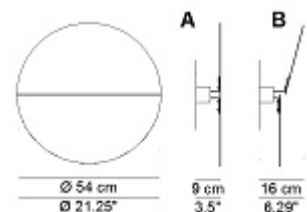

DESCRIZIONE

SORGENTE



IP

CODICE

Metal wall lamp white, lead grey or bronze NO DIM

1 led module 19,8W - 3420 Lm - 3000 K

• - IP20 BUTEAP054G01 870

Metal wall lamp Deluxe NO DIM

1 led module 19,8W - 3420 Lm - 3000 K

• - IP20 BUTEAP054G02 1.005

Wool fabric wall lamp NO DIM

1 led module 19,8W - 3420 Lm - 3000 K

• - IP20 BUTEAP054E01 1.145

Metal wall lamp white, lead grey or bronze DIM DALI - Push DIM

1 led module 19,8W - 3420 Lm - 3000 K

• - IP20 BUTEAP054G05 940

Metal wall lamp Deluxe DIM DALI - Push DIM

1 led module 19,8W - 3420 Lm - 3000 K

• - IP20 BUTEAP054G06 1.070

Wool fabric wall lamp DIM DALI - Push DIM

1 led module 19,8W - 3420 Lm - 3000 K

• - IP20 BUTEAP054E03 1.215

Wall lamp - ø 75

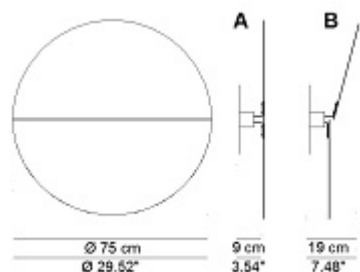

Metal wall lamp white, lead grey or bronze NO DIM

1 led module 29,8W - 5132 Lm - 3000 K

• - IP20 BUTEAP075G01 1.080

Metal wall lamp Deluxe NO DIM

1 led module 29,8W - 5132 Lm - 3000 K

• - IP20 BUTEAP075G02 1.245

Wool fabric wall lamp NO DIM

1 led module 29,8W - 5132 Lm - 3000 K

• - IP20 BUTEAP075E01 1.405

Metal wall lamp white, lead grey or bronze DIM DALI - Push DIM

1 led module 29,8W - 5132 Lm - 3000 K

• - IP20 BUTEAP075G05 1.145

Metal wall lamp Deluxe DIM DALI - Push DIM

1 led module 29,8W - 5132 Lm - 3000 K

• - IP20 BUTEAP075G06 1.315

Wool fabric wall lamp DIM DALI - Push DIM

1 led module 29,8W - 5132 Lm - 3000 K

• - IP20 BUTEAP075E03 1.475



A and B: option at the customer's choice upon installation (2 sets of brackets included)

- 0

PRODUCTS: Butterfly

DESIGN: design: Romano + Menegon 2021

Metal wall lamp painted in white, lead grey or bronze and in Deluxe finishing matt gold or available in the version with half discs covered in wool fabric with acoustic comfort features.

Symbol Index   → • / present - / absent OD / On Demand

BUTTERFLY

DESCRIZIONE

SORGENTE



IP

CODICE

Accessory recessed

Kit for recessed version for ø 54 (zinc-plated)

Kit for recessed version for ø 75 (zinc-plated)

•	IP20	BUTEDD054G01	85
•	IP20	BUTEDD075G01	100

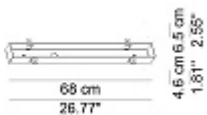
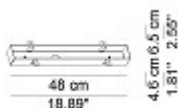



PRODUCTS: Campanone

DESIGN: design: Paolo Grasselli 2005

Pendant lamp with diffuser in white polyethylene or colored on the mix available in the orange and deep grey colours.

Opal plex finishing underneath.

On demand, diffuser available in other colours, for minimum quantities of 10 pieces.

Symbol Index   → • / present - / adsent OD / On Demand

CAMPANONE

DESCRIZIONE

SORGENTE



IP

CODICE

Pendant lamp

Medium pendant lamp ø 33

1xE27max watt 42 W HES

OD

OD

IP31

CAIESO033D01

435

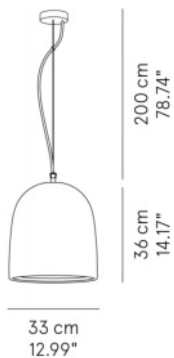

Pendant lamp

Maxi pendant lamp ø 51

1xE27max watt 70 W HES

OD

OD

IP31

CAIESO051D01

570

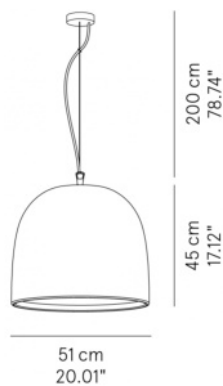

PRODUCTS: Campanone Outdoor
DESIGN: design: Paolo Grasselli 2005

Pendant lamp with diffuser in white polyethylene or colored on the mix available in the orange and deep grey colours.
 Opal plex finishing underneath.
 On demand, diffuser available in other colours, for minimum quantities of 10 pieces.
 Metal parts are protected with electrolytic galvanizing treatment and resistant polyester coating.

Symbol Index  → • / present - / adsent OD / On Demand

CAMPANONE OUTDOOR DESCRIZIONE

SORGENTE

  **IP** CODICE

Pendant lamp

Medium pendant lamp ø 33

1xE27max watt 42 W HES

OD OD IP65 CAOESO033D02 545

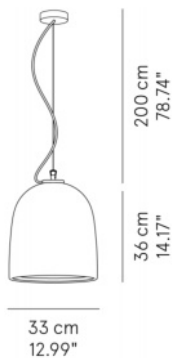

Pendant lamp

Maxi pendant lamp ø 51

1xE27max watt 70 W HES

OD OD IP65 CAOESO051D02 690

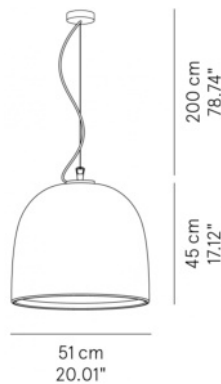

PRODUCTS: Chandelier
DESIGN: Paolo Grasselli 2019



Large pendant and ceiling lamp with arms.
 Wall lamp with one or two arms.
 Metal structure painted in white or black (embossed finishing) and in Deluxe finishing matt gold.

Symbol Index  → • / present - / adsent OD / On Demand

CHANDELIER

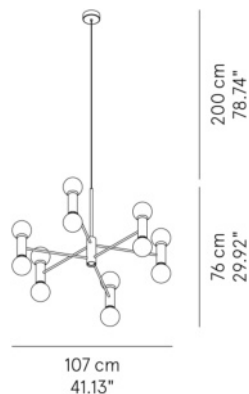
Pendant lamp - ø 100



DESCRIZIONE	SORGENTE			IP	CODICE	
Pendant lamp white or black	12xE27 + 1xGU10max watt 12 X 42W HES + 1 X 28W HES	•	OD	IP20	CHAESO100G01	1.910
Pendant lamp Deluxe	12xE27 + 1xGU10max watt 12 X 42W HES + 1 X 28W HES	•	OD	IP20	CHAESO100G02	2.165
Pendant lamp white or black with gold rod	12xE27 + 1xGU10max watt 12 X 42W HES + 1 X 28W HES	•	OD	IP20	CHAESO100G21	1.945
Pendant lamp Deluxe with gold rod	12xE27 + 1xGU10max watt 12 X 42W HES + 1 X 28W HES	•	OD	IP20	CHAESO100G22	2.195
Kit light bulbs: 12 x E27 Globe 125 LED 9W 2700K (NO DIM) + 1 x GU10 LED (NO DIM)					LMPLEDE27KIT011	400
Kit light bulbs: 12 x E27 Globe 125 LED 7W 2200K (DIM) + 1 x GU10 LED (DIM)					LMPLEDE27KIT012	440

Pendant lamp - ø 100

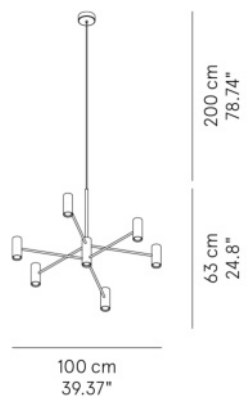

Pendant lamp white or black	13xGU10max watt 28 W HES	•	OD	IP20	CHAESO100G11	1.935
Pendant lamp Deluxe	13xGU10max watt 28 W HES	•	OD	IP20	CHAESO100G12	2.190
Pendant lamp white or black with gold rod	13xGU10max watt 28 W HES	•	OD	IP20	CHAESO100G31	1.970
Pendant lamp Deluxe with gold rod	13xGU10max watt 28 W HES	•	OD	IP20	CHAESO100G32	2.220
Kit 13 light bulbs GU10 LED (NO DIM)					LMPLEDGU10KIT11	180
Kit 13 light bulbs GU10 LED (DIM)					LMPLEDGU10KIT12	285

PRODUCTS: Chandelier
DESIGN: Paolo Grasselli 2019

Large pendant and ceiling lamp with arms.
 Wall lamp with one or two arms.
 Metal structure painted in white or black (embossed finishing) and in Deluxe finishing matt gold.



Symbol Index  → • / present - / adsent OD / On Demand

CHANDELIER

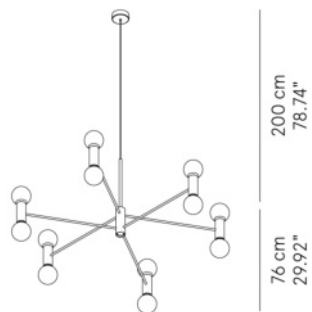
Pendant lamp - ø 140



147 cm
57.87"

DESCRIZIONE	SORGENTE			IP	CODICE	
Pendant lamp white or black	12xE27 + 1xGU10max watt 12 X 42W HES + 1 X 28W HES	•	OD	IP20	CHAESO140G01	2.010
Pendant lamp Deluxe	12xE27 + 1xGU10max watt 12 X 42W HES + 1 X 28W HES	•	OD	IP20	CHAESO140G02	2.350
Pendant lamp white or black with gold rod	12xE27 + 1xGU10max watt 12 X 42W HES + 1 X 28W HES	•	OD	IP20	CHAESO140G21	2.040
Pendant lamp Deluxe with gold rod	12xE27 + 1xGU10max watt 12 X 42W HES + 1 X 28W HES	•	OD	IP20	CHAESO140G22	2.385
Kit light bulbs: 12 x E27 Globe 125 LED 9W 2700K (NO DIM) + 1 x GU10 LED (NO DIM)					LMPLEDE27KIT011	400
Kit light bulbs: 12 x E27 Globe 125 LED 7W 2200K (DIM) + 1 x GU10 LED (DIM)					LMPLEDE27KIT012	440

Pendant lamp - ø 140

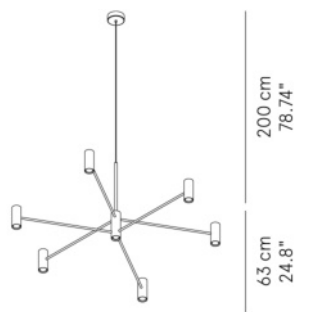

140 cm
55.12"

Pendant lamp white or black	13xGU10max watt 28 W HES	•	OD	IP20	CHAESO140G11	2.035
Pendant lamp Deluxe	13xGU10max watt 28 W HES	•	OD	IP20	CHAESO140G12	2.380
Pendant lamp white or black with gold rod	13xGU10max watt 28 W HES	•	OD	IP20	CHAESO140G31	2.070
Pendant lamp Deluxe with gold rod	13xGU10max watt 28 W HES	•	OD	IP20	CHAESO140G32	2.415
Kit 13 light bulbs GU10 LED (NO DIM)					LMPLEDGU10KIT11	180
Kit 13 light bulbs GU10 LED (DIM)					LMPLEDGU10KIT12	285

PRODUCTS: Chandelier
DESIGN: Paolo Grasselli 2019

Large pendant and ceiling lamp with arms.

Wall lamp with one or two arms.

Metal structure painted in white or black (embossed finishing) and in Deluxe finishing matt gold.

Symbol Index  → • / present - / absent OD / On Demand



CHANDELIER

Ceiling lamp - ø 100



62 cm
24.41"

107 cm
41.13"

DESCRIZIONE	SORGENTE			IP	CODICE	
Ceiling lamp white or black	6xE27 + 7xGU10max watt 6 X 42W HES + 7 X 28W HES	•	OD	IP20	CHAEPL100G01	1.900
Ceiling lamp Deluxe	6xE27 + 7xGU10max watt 6 X 42W HES + 7 X 28W HES	•	OD	IP20	CHAEPL100G02	2.155
Ceiling lamp white or black with gold rod	6xE27 + 7xGU10max watt 6 X 42W HES + 7 X 28W HES	•	OD	IP20	CHAEPL100G21	1.930
Ceiling lamp Deluxe with gold rod	6xE27 + 7xGU10max watt 6 X 42W HES + 7 X 28W HES	•	OD	IP20	CHAEPL100G22	2.185
Kit light bulbs: 6 x E27 Globe 125 LED 9W 2700K (NO DIM) + 7 x GU10 LED (NO DIM)					LMPLEDE27KIT013	280
Kit light bulbs: 6 x E27 Globe 125 LED 7W 2200K (DIM) + 7 x GU10 LED (DIM)					LMPLEDE27KIT014	370

Ceiling lamp - ø 100



49 cm
19.29"

100 cm
39.37"

Ceiling lamp white or black	13xGU10max watt 28 W HES	•	OD	IP20	CHAEPL100G11	1.910
Ceiling lamp Deluxe	13xGU10max watt 28 W HES	•	OD	IP20	CHAEPL100G12	2.165
Ceiling lamp white or black with gold rod	13xGU10max watt 28 W HES	•	OD	IP20	CHAEPL100G31	1.945
Ceiling lamp Deluxe with gold rod	13xGU10max watt 28 W HES	•	OD	IP20	CHAEPL100G32	2.195
Kit 13 light bulbs GU10 LED (NO DIM)					LMPLEDGU10KIT11	180
Kit 13 light bulbs GU10 LED (DIM)					LMPLEDGU10KIT12	285

PRODUCTS: Chandelier
DESIGN: Paolo Grasselli 2019



Large pendant and ceiling lamp with arms.
 Wall lamp with one or two arms.
 Metal structure painted in white or black (embossed finishing) and in Deluxe finishing matt gold.

Symbol Index  → • / present - / adsent OD / On Demand

CHANDELIER

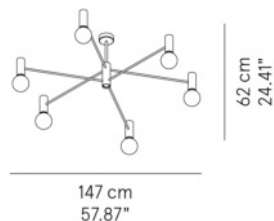
Ceiling lamp - ø 140



DESCRIZIONE	SORGENTE			IP	CODICE	
Ceiling lamp white or black	6xE27 + 7xGU10max watt 6 X 42W HES + 7 X 28W HES	•	OD	IP20	CHAEPL140G01	1.995
Ceiling lamp Deluxe	6xE27 + 7xGU10max watt 6 X 42W HES + 7 X 28W HES	•	OD	IP20	CHAEPL140G02	2.335
Ceiling lamp white or black with gold rod	6xE27 + 7xGU10max watt 6 X 42W HES + 7 X 28W HES	•	OD	IP20	CHAEPL140G21	2.025
Ceiling lamp Deluxe with gold rod	6xE27 + 7xGU10max watt 6 X 42W HES + 7 X 28W HES	•	OD	IP20	CHAEPL140G22	2.370
Kit light bulbs: 6 x E27 Globe 125 LED 9W 2700K (NO DIM) + 7 x GU10 LED (NO DIM)					LMPLEDE27KIT013	280
Kit light bulbs: 6 x E27 Globe 125 LED 7W 2200K (DIM) + 7 x GU10 LED (DIM)					LMPLEDE27KIT014	370

Ceiling lamp - ø 140

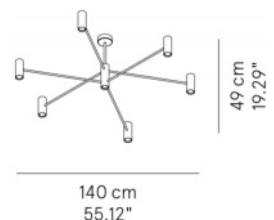

Ceiling lamp white or black	13xGU10max watt 28 W HES	•	OD	IP20	CHAEPL140G11	2.010
Ceiling lamp Deluxe	13xGU10max watt 28 W HES	•	OD	IP20	CHAEPL140G12	2.350
Ceiling lamp white or black with gold rod	13xGU10max watt 28 W HES	•	OD	IP20	CHAEPL140G31	2.040
Ceiling lamp Deluxe with gold rod	13xGU10max watt 28 W HES	•	OD	IP20	CHAEPL140G32	2.385
Kit 13 light bulbs GU10 LED (NO DIM)					LMPLEDGU10KIT11	180
Kit 13 light bulbs GU10 LED (DIM)					LMPLEDGU10KIT12	285

Wall lamp - single

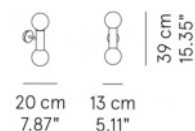

Wall lamp white or black	2xE27max watt 42 W HES	•	OD	IP20	CHAEAP010G01	350
Wall lamp Deluxe	2xE27max watt 42 W HES	•	OD	IP20	CHAEAP010G02	425
Kit 2 x light bulbs E27 Globe 125 LED 9W 2700K (NO DIM)					LMPLEDE27KIT001	85
Kit 2 x light bulbs E27 Globe 125 LED 7W 2200K (DIM)					LMPLEDE27KIT002	95

PRODUCTS: Chandelier
DESIGN: Paolo Grasselli 2019



Large pendant and ceiling lamp with arms.
 Wall lamp with one or two arms.
 Metal structure painted in white or black (embossed finishing) and in Deluxe finishing matt gold.

Symbol Index  → • / present - / adsent OD / On Demand

CHANDELIER

Wall lamp - single



DESCRIZIONE	SORGENTE			IP	CODICE	
Wall lamp white or black	2xGU10max watt 28W HES	•	OD	IP20	CHAEAP010G11	355
Wall lamp Deluxe	2xGU10max watt 28W HES	•	OD	IP20	CHAEAP010G12	430
Kit 2 light bulbs GU10 LED (NO DIM)					LMPLEDCU10KIT01	35
Kit 2 light bulbs GU10 LED (DIM)					LMPLEDCU10KIT02	55

Wall lamp - double

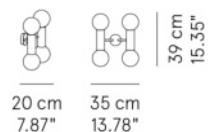

Wall lamp white or black	4xE27max watt 42 W HES	•	OD	IP20	CHAEAP035G01	580
Wall lamp Deluxe	4xE27max watt 42 W HES	•	OD	IP20	CHAEAP035G02	665
Kit 4 x light bulbs E27 Globe 125 LED 9W 2700K (NO DIM)					LMPLEDE27KIT003	135
Kit 4 x light bulbs E27 Globe 125 LED 7W 2200K (DIM)					LMPLEDE27KIT004	160

Wall lamp - double



Wall lamp white or black	4xGU10max watt 28W HES	•	OD	IP20	CHAEAP035G11	590
Wall lamp Deluxe	4xGU10max watt 28W HES	•	OD	IP20	CHAEAP035G12	675
Kit 4 light bulbs GU10 LED (NO DIM)					LMPLEDCU10KIT03	60
Kit 4 light bulbs GU10 LED (DIM)					LMPLEDCU10KIT04	70

PRODUCTS: Chandelier Longue

DESIGN: Paolo Grasselli 2019

Large pendant and ceiling lamp with arms.

Wall lamp with one or two arms.

Metal structure painted in white or black (embossed finishing) and in Deluxe finishing matt gold.

Symbol Index  → • / present - / absent OD / On Demand

CHANDELIER LONGUE DESCRIZIONE

Pendant lamp - L. 100

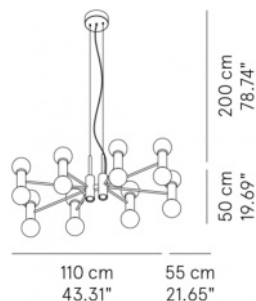

Pendant lamp white or black

SORGENTE

16xE27 + 2xGU10max watt 16 X 42W HES + 2 X 28W HES



IP

CODICE

• OD IP20 CHLESO100G01 2.405

Pendant lamp Deluxe

16xE27 + 2xGU10max watt 16 X 42W HES + 2 X 28W HES

• OD IP20 CHLESO100G02 2.680

Pendant lamp white or black with gold rod

16xE27 + 2xGU10max watt 16 X 42W HES + 2 X 28W HES

• OD IP20 CHLESO100G21 2.470

Pendant lamp Deluxe with gold rod

16xE27 + 2xGU10max watt 16 X 42W HES + 2 X 28W HES

• OD IP20 CHLESO100G22 2.740

Kit light bulbs: 16 x E27 Globe 125 LED 9W 2700K (NO DIM) + 2 x GU10 LED (NO DIM)

LMPLEDE27KIT016 495

Kit light bulbs: 16 x E27 Globe 125 LED 7W 2200K (DIM) + 2 x GU10 LED (DIM)

LMPLEDE27KIT017 600

Pendant lamp - L. 100

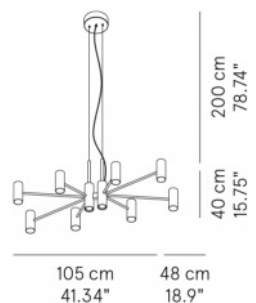

Pendant lamp white or black

18xGU10max watt 28 W HES

• OD IP20 CHLESO100G11 2.445

Pendant lamp Deluxe

18xGU10max watt 28 W HES

• OD IP20 CHLESO100G12 2.720

Pendant lamp white or black with gold rod

18xGU10max watt 28 W HES

• OD IP20 CHLESO100G31 2.510

Pendant lamp Deluxe with gold rod

18xGU10max watt 28 W HES

• OD IP20 CHLESO100G32 2.785

Kit 18 light bulbs GU10 LED (NO DIM)

LMPLEDGU10KIT18 250

Kit 18 light bulbs GU10 LED (DIM)

LMPLEDGU10KIT19 380

PRODUCTS: Chandelier Longue

DESIGN: Paolo Grasselli 2019

Large pendant and ceiling lamp with arms.

Wall lamp with one or two arms.

Metal structure painted in white or black (embossed finishing) and in Deluxe finishing matt gold.

Symbol Index   → • / present - / adsent OD / On Demand

CHANDELIER LONGUE DESCRIZIONE

Pendant lamp - L. 150

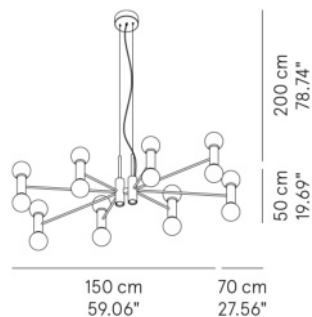

Pendant lamp white or black

SORGENTE

16xE27 + 2xGU10max watt 16 X 42W HES + 2 X 28W HES



IP

CODICE

• OD IP20 CHLESO150G01 2.535

Pendant lamp Deluxe

16xE27 + 2xGU10max watt 16 X 42W HES + 2 X 28W HES

• OD IP20 CHLESO150G02 2.850

Pendant lamp white or black with gold rod

16xE27 + 2xGU10max watt 16 X 42W HES + 2 X 28W HES

• OD IP20 CHLESO150G21 2.600

Pendant lamp Deluxe with gold rod

16xE27 + 2xGU10max watt 16 X 42W HES + 2 X 28W HES

• OD IP20 CHLESO150G22 2.915

Kit light bulbs: 16 x E27 Globe 125 LED 9W 2700K (NO DIM) + 2 x GU10 LED (NO DIM)

LMPLEDE27KIT016 495

Kit light bulbs: 16 x E27 Globe 125 LED 7W 2200K (DIM) + 2 x GU10 LED (DIM)

LMPLEDE27KIT017 600

Pendant lamp - L. 150

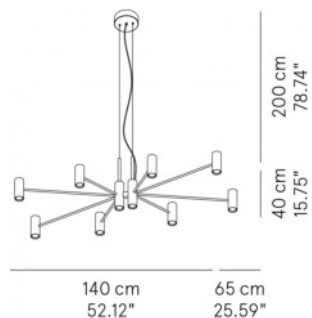

Pendant lamp white or black

18xGU10max watt 28 W HES

• OD IP20 CHLESO150G11 2.590

Pendant lamp Deluxe

18xGU10max watt 28 W HES

• OD IP20 CHLESO150G12 2.905

Pendant lamp white or black with gold rod

18xGU10max watt 28 W HES

• OD IP20 CHLESO150G31 2.650

Pendant lamp Deluxe with gold rod

18xGU10max watt 28 W HES

• OD IP20 CHLESO150G32 2.970

Kit 18 light bulbs GU10 LED (NO DIM)

LMPLEDGU10KIT18 250

Kit 18 light bulbs GU10 LED (DIM)

LMPLEDGU10KIT19 380

PRODUCTS: Chandelier Longue

DESIGN: Paolo Grasselli 2019

Large pendant and ceiling lamp with arms.

Wall lamp with one or two arms.

Metal structure painted in white or black (embossed finishing) and in Deluxe finishing matt gold.

Symbol Index  → • / present - / adsent OD / On Demand

CHANDELIER LONGUE DESCRIZIONE

Ceiling lamp - L. 100

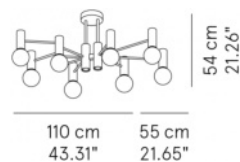

Ceiling lamp white or black

SORGENTE



IP

CODICE

8xE27 + 10xGU10max watt 8 X 42W HES + 10 X 28W HES

• OD IP20 CHLEPL100G01 2.395

Ceiling lamp Deluxe

8xE27 + 10xGU10max watt 8 X 42W HES + 10 X 28W HES

• OD IP20 CHLEPL100G02 2.665

Ceiling lamp white or black with gold rod

8xE27 + 10xGU10max watt 8 X 42W HES + 10 X 28W HES

• OD IP20 CHLEPL100G21 2.455

Ceiling lamp Deluxe with gold rod

8xE27 + 10xGU10max watt 8 X 42W HES + 10 X 28W HES

• OD IP20 CHLEPL100G22 2.730

Kit light bulbs: 8 x E27 Globe 125 LED 9W 2700K (NO DIM) + 10 x GU10 LED (NO DIM)

LMPLEDE27KIT160 380

Kit light bulbs: 8 x E27 Globe 125 LED 7W 2200K (DIM) + 10 x GU10 LED (DIM)

LMPLEDE27KIT170 505

Ceiling lamp - L. 100

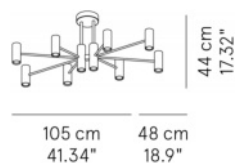

Ceiling lamp white or black

18xGU10max watt 28 W HES

• OD IP20 CHLEPL100G11 2.415

Ceiling lamp Deluxe

18xGU10max watt 28 W HES

• OD IP20 CHLEPL100G12 2.690

Ceiling lamp white or black with gold rod

18xGU10max watt 28 W HES

• OD IP20 CHLEPL100G31 2.480

Ceiling lamp Deluxe with gold rod

18xGU10max watt 28 W HES

• OD IP20 CHLEPL100G32 2.750

Kit 18 light bulbs GU10 LED (NO DIM)

LMPLEDGU10KIT18 250

Kit 18 light bulbs GU10 LED (DIM)

LMPLEDGU10KIT19 380

PRODUCTS: Chandelier Longue

DESIGN: Paolo Grasselli 2019

Large pendant and ceiling lamp with arms.

Wall lamp with one or two arms.

Metal structure painted in white or black (embossed finishing) and in Deluxe finishing matt gold.

Symbol Index  → • / present - / adsent OD / On Demand

CHANDELIER LONGUE DESCRIZIONE

Ceiling lamp - L. 150

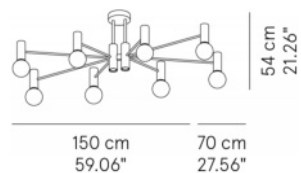

Ceiling lamp white or black

SORGENTE



IP

CODICE

8xE27 + 10xGU10max watt 8 X 42W HES + 10 X 28W HES

• OD IP20 CHLEPL150G01 2.535

Ceiling lamp Deluxe

8xE27 + 10xGU10max watt 8 X 42W HES + 10 X 28W HES

• OD IP20 CHLEPL150G02 2.850

Ceiling lamp white or black with gold rod

8xE27 + 10xGU10max watt 8 X 42W HES + 10 X 28W HES

• OD IP20 CHLEPL150G21 2.600

Ceiling lamp Deluxe with gold rod

8xE27 + 10xGU10max watt 8 X 42W HES + 10 X 28W HES

• OD IP20 CHLEPL150G22 2.915

Kit light bulbs: 8 x E27 Globe 125 LED 9W 2700K (NO DIM) + 10 x GU10 LED (NO DIM)

LMPLEDE27KIT160 380

Kit light bulbs: 8 x E27 Globe 125 LED 7W 2200K (DIM) + 10 x GU10 LED (DIM)

LMPLEDE27KIT170 505

Ceiling lamp - L. 150

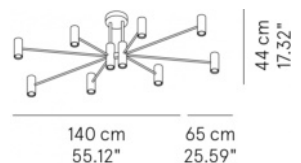

Ceiling lamp white or black

18xGU10max watt 28 W HES

• OD IP20 CHLEPL150G11 2.555

Ceiling lamp Deluxe

18xGU10max watt 28 W HES

• OD IP20 CHLEPL150G12 2.870

Ceiling lamp white or black with gold rod

18xGU10max watt 28 W HES

• OD IP20 CHLEPL150G31 2.620

Ceiling lamp Deluxe with gold rod

18xGU10max watt 28 W HES

• OD IP20 CHLEPL150G32 2.940

Kit 18 light bulbs GU10 LED (NO DIM)

LMPLEDGU10KIT18 250

Kit 18 light bulbs GU10 LED (DIM)

LMPLEDGU10KIT19 380

PRODUCTS: Cilindro

DESIGN: design: Modoluce R&D 2002

Cylindrical pendant lamp available in cotton, washable, velvet, wool, pleated and pleated ribbon fabrics.

On demand, lampshade available in For nature and Kvadrat fabrics (with surcharge).

Opal plex finishing underneath.



On demand, the pendant lamp can have a top protective disk in plex, usable only with LED bulbs or modules, with surcharge as per price list.

Symbol Index  → • / present - / absent OD / On Demand

CILINDRO

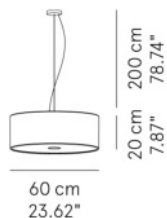
Pendant lamp - ø 60



DESCRIZIONE	SORGENTE			IP	CODICE	
1 light cotton	1xE27max watt 70 W HES	OD	OD	IP20	CILESP060C01	605
1 light washable	1xE27max watt 70 W HES	OD	OD	IP20	CILESP060T01	685
1 light velvet	1xE27max watt 70 W HES	OD	OD	IP20	CILESP060O01	700
1 light wool	1xE27max watt 70 W HES	OD	OD	IP20	CILESP060E01	700
3 lights cotton	3xE27max watt 70 W HES	OD	OD	IP20	CILESP060C02	675
3 lights washable	3xE27max watt 70 W HES	OD	OD	IP20	CILESP060T02	755
3 lights velvet	3xE27max watt 70 W HES	OD	OD	IP20	CILESP060O02	770
3 lights wool	3xE27max watt 70 W HES	OD	OD	IP20	CILESP060E02	770
3 lights pleated fabric	3xE27max watt 70 W HES	OD	OD	IP20	CILESP060P01	810
3 lights pleated ribbon fabric	3xE27max watt 70 W HES	OD	OD	IP20	CILESP060R01	840
1 light cotton NO DIM	1 led module 23 W - 3628 Lm - 2700 K	OD	OD	IP20	CILESP060C06	860
1 light washable NO DIM	1 led module 23 W - 3628 Lm - 2700 K	OD	OD	IP20	CILESP060T06	940
1 light velvet NO DIM	1 led module 23 W - 3628 Lm - 2700 K	OD	OD	IP20	CILESP060O06	955
1 light wool NO DIM	1 led module 23 W - 3628 Lm - 2700 K	OD	OD	IP20	CILESP060E06	955
1 light pleated fabric NO DIM	1 led module 23 W - 3628 Lm - 2700 K	OD	OD	IP20	CILESP060P05	990
1 light pleated ribbon fabric NO DIM	1 led module 23 W - 3628 Lm - 2700 K	OD	OD	IP20	CILESP060R05	1.030
1 light cotton DIM TRIAC	1 led module 23 W - 3628 Lm - 2700 K	OD	OD	IP20	CILESP060C09	965
1 light washable DIM TRIAC	1 led module 23 W - 3628 Lm - 2700 K	OD	OD	IP20	CILESP060T09	1.045
1 light velvet DIM TRIAC	1 led module 23 W - 3628 Lm - 2700 K	OD	OD	IP20	CILESP060O09	1.060
1 light wool DIM TRIAC	1 led module 23 W - 3628 Lm - 2700 K	OD	OD	IP20	CILESP060E09	1.060
1 light pleated fabric DIM TRIAC	1 led module 23 W - 3628 Lm - 2700 K	OD	OD	IP20	CILESP060P09	1.095
1 light pleated ribbon fabric DIM TRIAC	1 led module 23 W - 3628 Lm - 2700 K	OD	OD	IP20	CILESP060R09	1.130

PRODUCTS: Cilindro

DESIGN: design: Modoluce R&D 2002

Cylindrical pendant lamp available in cotton, washable, velvet, wool, pleated and pleated ribbon fabrics.

On demand, lampshade available in For nature and Kvadrat fabrics (with surcharge).

Opal plex finishing underneath.

On demand, the pendant lamp can have a top protective disk in plex, usable only with LED bulbs or modules, with surcharge as per price list.

Symbol Index  → • / present - / adsent OD / On Demand

CILINDRO

Pendant lamp - ø 60

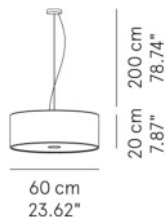

DESCRIZIONE

SORGENTE



IP

CODICE

1 light cotton DIM DALI-Push DIM

1 led module 23 W - 3628 Lm - 2700 K

OD OD IP20 CILESP060C08 945

1 light washable DIM DALI-Push DIM

1 led module 23 W - 3628 Lm - 2700 K

OD OD IP20 CILESP060T08 1.020

1 light velvet DIM DALI-Push DIM

1 led module 23 W - 3628 Lm - 2700 K

OD OD IP20 CILESP060O08 1.040

1 light wool DIM DALI-Push DIM

1 led module 23 W - 3628 Lm - 2700 K

OD OD IP20 CILESP060E08 1.040

1 light pleated fabric DIM DALI-Push DIM

1 led module 23 W - 3628 Lm - 2700 K

OD OD IP20 CILESP060P07 1.075

1 light pleated ribbon fabric DIM DALI-Push DIM

1 led module 23 W - 3628 Lm - 2700 K

OD OD IP20 CILESP060R07 1.110

Accessory

Top protective disk in opal plex

OD IP20 CILEPX060F01 140



PRODUCTS: Cilindro

DESIGN: design: Modoluce R&D 2002

Cylindrical pendant lamp available in cotton, washable, velvet, wool, pleated and pleated ribbon fabrics.

On demand, lampshade available in For nature and Kvadrat fabrics (with surcharge).

Opal plex finishing underneath.



On demand, the pendant lamp can have a top protective disk in plex, usable only with LED bulbs or modules, with surcharge as per price list.

Symbol Index  → • / present - / absent OD / On Demand

CILINDRO

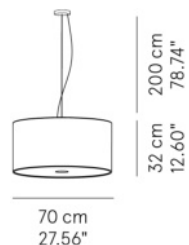
Pendant lamp - ø 70



DESCRIZIONE	SORGENTE			IP	CODICE	
1 light cotton	1xE27max watt 70 W HES	OD	OD	IP20	CILESP070C01	700
1 light washable	1xE27max watt 70 W HES	OD	OD	IP20	CILESP070T01	830
1 light velvet	1xE27max watt 70 W HES	OD	OD	IP20	CILESP070O01	860
1 light wool	1xE27max watt 70 W HES	OD	OD	IP20	CILESP070E01	860
3 lights cotton	3xE27max watt 70 W HES	OD	OD	IP20	CILESP070C02	755
3 lights washable	3xE27max watt 70 W HES	OD	OD	IP20	CILESP070T02	880
3 lights velvet	3xE27max watt 70 W HES	OD	OD	IP20	CILESP070O02	920
3 lights wool	3xE27max watt 70 W HES	OD	OD	IP20	CILESP070E02	920
3 lights pleated fabric	3xE27max watt 70 W HES	OD	OD	IP20	CILESP070P01	1.105
3 lights pleated ribbon fabric	3xE27max watt 70 W HES	OD	OD	IP20	CILESP070R01	1.145
1 light cotton NO DIM	1 led module 23 W - 3628 Lm - 2700 K	OD	OD	IP20	CILESP070C06	955
1 light washable NO DIM	1 led module 23 W - 3628 Lm - 2700 K	OD	OD	IP20	CILESP070T06	1.085
1 light velvet NO DIM	1 led module 23 W - 3628 Lm - 2700 K	OD	OD	IP20	CILESP070O06	1.120
1 light wool NO DIM	1 led module 23 W - 3628 Lm - 2700 K	OD	OD	IP20	CILESP070E06	1.120
1 light pleated fabric NO DIM	1 led module 23 W - 3628 Lm - 2700 K	OD	OD	IP20	CILESP070P05	1.305
1 light pleated ribbon fabric NO DIM	1 led module 23 W - 3628 Lm - 2700 K	OD	OD	IP20	CILESP070R05	1.350
1 light cotton DIM TRIAC	1 led module 23 W - 3628 Lm - 2700 K	OD	OD	IP20	CILESP070C09	1.030
1 light washable DIM TRIAC	1 led module 23 W - 3628 Lm - 2700 K	OD	OD	IP20	CILESP070T09	1.155
1 light velvet DIM TRIAC	1 led module 23 W - 3628 Lm - 2700 K	OD	OD	IP20	CILESP070O09	1.190
1 light wool DIM TRIAC	1 led module 23 W - 3628 Lm - 2700 K	OD	OD	IP20	CILESP070E09	1.190
1 light pleated fabric DIM TRIAC	1 led module 23 W - 3628 Lm - 2700 K	OD	OD	IP20	CILESP070P09	1.375
1 light pleated ribbon fabric DIM TRIAC	1 led module 23 W - 3628 Lm - 2700 K	OD	OD	IP20	CILESP070R09	1.420

PRODUCTS: Cilindro

DESIGN: design: Modoluce R&D 2002

Cylindrical pendant lamp available in cotton, washable, velvet, wool, pleated and pleated ribbon fabrics.

On demand, lampshade available in For nature and Kvadrat fabrics (with surcharge).

Opal plex finishing underneath.

On demand, the pendant lamp can have a top protective disk in plex, usable only with LED bulbs or modules, with surcharge as per price list.

Symbol Index  → • / present - / adsent OD / On Demand

CILINDRO

Pendant lamp - ø 70

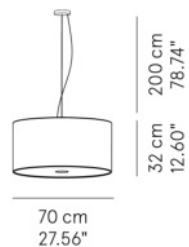

DESCRIZIONE	SORGENTE			IP	CODICE	
1 light cotton DIM DALI-Push DIM	1 led module 23 W - 3628 Lm - 2700 K	OD	OD	IP20	CILESP070C08	1.005
1 light washable DIM DALI-Push DIM	1 led module 23 W - 3628 Lm - 2700 K	OD	OD	IP20	CILESP070T08	1.135
1 light velvet DIM DALI-Push DIM	1 led module 23 W - 3628 Lm - 2700 K	OD	OD	IP20	CILESP070O08	1.170
1 light wool DIM DALI-Push DIM	1 led module 23 W - 3628 Lm - 2700 K	OD	OD	IP20	CILESP070E08	1.170
1 light pleated fabric DIM DALI-Push DIM	1 led module 23 W - 3628 Lm - 2700 K	OD	OD	IP20	CILESP070P07	1.355
1 light pleated ribbon fabric DIM DALI-Push DIM	1 led module 23 W - 3628 Lm - 2700 K	OD	OD	IP20	CILESP070R07	1.395

Accessory

Top protective disk in opal plex

OD IP20 CILEPX070F01 195

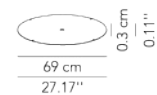

PRODUCTS: Cilindro



DESIGN: design: Modoluce R&D 2002

Cylindrical pendant lamp available in cotton, washable, velvet, wool, pleated and pleated ribbon fabrics.

On demand, lampshade available in For nature and Kvadrat fabrics (with surcharge).

Opal plex finishing underneath.



On demand, the pendant lamp can have a top protective disk in plex, usable only with LED bulbs or modules, with surcharge as per price list.

Symbol Index   → • / present - / absent OD / On Demand

CILINDRO

Pendant lamp - ø 100



DESCRIZIONE	SORGENTE			IP	CODICE	
4 lights cotton	4xE27max watt 105 W HES	OD	OD	IP20	CILESP100C01	1.345
4 lights washable	4xE27max watt 105 W HES	OD	OD	IP20	CILESP100T01	1.530
4 lights velvet	4xE27max watt 105 W HES	OD	OD	IP20	CILESP100O01	1.575
4 lights wool	4xE27max watt 105 W HES	OD	OD	IP20	CILESP100E01	1.575
4 lights pleated fabric	4xE27max watt 105 W HES	OD	OD	IP20	CILESP100P01	2.000
4 lights pleated ribbon fabric	4xE27max watt 105 W HES	OD	OD	IP20	CILESP100R01	2.055
1 light cotton NO DIM	1 led module 23 W - 3628 Lm - 2700 K	OD	OD	IP20	CILESP100C08	1.420
1 light washable NO DIM	1 led module 23 W - 3628 Lm - 2700 K	OD	OD	IP20	CILESP100T08	1.605
1 light velvet NO DIM	1 led module 23 W - 3628 Lm - 2700 K	OD	OD	IP20	CILESP100O08	1.650
1 light wool NO DIM	1 led module 23 W - 3628 Lm - 2700 K	OD	OD	IP20	CILESP100E08	1.650
1 light pleated fabric NO DIM	1 led module 23 W - 3628 Lm - 2700 K	OD	OD	IP20	CILESP100P08	2.075
1 light pleated ribbon fabric NO DIM	1 led module 23 W - 3628 Lm - 2700 K	OD	OD	IP20	CILESP100R08	2.130
1 light cotton DIM TRIAC	1 led module 23 W - 3628 Lm - 2700 K	OD	OD	IP20	CILESP100C09	1.490
1 light washable DIM TRIAC	1 led module 23 W - 3628 Lm - 2700 K	OD	OD	IP20	CILESP100T09	1.675
1 light velvet DIM TRIAC	1 led module 23 W - 3628 Lm - 2700 K	OD	OD	IP20	CILESP100O09	1.720
1 light wool DIM TRIAC	1 led module 23 W - 3628 Lm - 2700 K	OD	OD	IP20	CILESP100E09	1.720
1 light pleated fabric DIM TRIAC	1 led module 23 W - 3628 Lm - 2700 K	OD	OD	IP20	CILESP100P09	2.145
1 light pleated ribbon fabric DIM TRIAC	1 led module 23 W - 3628 Lm - 2700 K	OD	OD	IP20	CILESP100R09	2.200
1 light cotton DIM DALI-Push DIM	1 led module 23 W - 3628 Lm - 2700 K	OD	OD	IP20	CILESP100C10	1.470
1 light washable DIM DALI-Push DIM	1 led module 23 W - 3628 Lm - 2700 K	OD	OD	IP20	CILESP100T10	1.655
1 light velvet DIM DALI-Push DIM	1 led module 23 W - 3628 Lm - 2700 K	OD	OD	IP20	CILESP100O10	1.695
1 light wool DIM DALI-Push DIM	1 led module 23 W - 3628 Lm - 2700 K	OD	OD	IP20	CILESP100E10	1.695
1 light pleated fabric DIM DALI-Push DIM	1 led module 23 W - 3628 Lm - 2700 K	OD	OD	IP20	CILESP100P10	2.125
1 light pleated ribbon fabric DIM DALI-Push DIM	1 led module 23 W - 3628 Lm - 2700 K	OD	OD	IP20	CILESP100R10	2.180

PRODUCTS: Cilindro
DESIGN: design: Modoluce R&D 2002



Cylindrical pendant lamp available in cotton, washable, velvet, wool, pleated and pleated ribbon fabrics.
 On demand, lampshade available in For nature and Kvadrat fabrics (with surcharge).
 Opal plex finishing underneath.
 On demand, the pendant lamp can have a top protective disk in plex, usable only with LED bulbs or modules, with surcharge as per price list.

Symbol Index  → • / present - / absent OD / On Demand

CILINDRO

Pendant lamp - ø 100



DESCRIZIONE	SORGENTE			IP	CODICE	
1 light cotton NO DIM	1 led module 57 W - 8750 Lm - 2700 K	OD	OD	IP20	CILESP100C13	1.630
1 light washable NO DIM	1 led module 57 W - 8750 Lm - 2700 K	OD	OD	IP20	CILESP100T13	1.810
1 light velvet NO DIM	1 led module 57 W - 8750 Lm - 2700 K	OD	OD	IP20	CILESP100O13	1.860
1 light wool NO DIM	1 led module 57 W - 8750 Lm - 2700 K	OD	OD	IP20	CILESP100E13	1.860
1 light pleated fabric NO DIM	1 led module 57 W - 8750 Lm - 2700 K	OD	OD	IP20	CILESP100P13	2.285
1 light pleated ribbon fabric NO DIM/ DIM 1-10V	1 led module 57 W - 8750 Lm - 2700 K	OD	OD	IP20	CILESP100R13	2.335
1 light cotton DIM TRIAC	1 led module 57 W - 8750 Lm - 2700 K	OD	OD	IP20	CILESP100C14	1.690
1 light washable DIM TRIAC	1 led module 57 W - 8750 Lm - 2700 K	OD	OD	IP20	CILESP100T14	1.880
1 light velvet DIM TRIAC	1 led module 57 W - 8750 Lm - 2700 K	OD	OD	IP20	CILESP100O14	1.920
1 light wool DIM TRIAC	1 led module 57 W - 8750 Lm - 2700 K	OD	OD	IP20	CILESP100E14	1.920
1 light pleated fabric DIM TRIAC	1 led module 57 W - 8750 Lm - 2700 K	OD	OD	IP20	CILESP100P14	2.345
1 light pleated ribbon fabric DIM TRIAC	1 led module 57 W - 8750 Lm - 2700 K	OD	OD	IP20	CILESP100R14	2.405
1 light cotton DIM DALI-Push DIM	1 led module 57 W - 8750 Lm - 2700 K	OD	OD	IP20	CILESP100C15	1.735
1 light washable DIM DALI-Push DIM	1 led module 57 W - 8750 Lm - 2700 K	OD	OD	IP20	CILESP100T15	1.915
1 light velvet DIM DALI-Push DIM	1 led module 57 W - 8750 Lm - 2700 K	OD	OD	IP20	CILESP100O15	1.960
1 light wool DIM DALI-Push DIM	1 led module 57 W - 8750 Lm - 2700 K	OD	OD	IP20	CILESP100E15	1.960
1 light pleated fabric DIM DALI-Push DIM	1 led module 57 W - 8750 Lm - 2700 K	OD	OD	IP20	CILESP100P15	2.385
1 light pleated ribbon fabric DIM DALI-Push DIM	1 led module 57 W - 8750 Lm - 2700 K	OD	OD	IP20	CILESP100R15	2.440

Accessory

Top protective disk in opal plex

OD IP20 CILEPX100F01 405

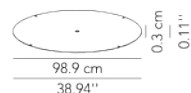

PRODUCTS: Cilindro



DESIGN: design: Modoluce R&D 2002

Cylindrical pendant lamp available in cotton, washable, velvet, wool, pleated and pleated ribbon fabrics.

On demand, lampshade available in For nature and Kvadrat fabrics (with surcharge).

Opal plex finishing underneath.



On demand, the pendant lamp can have a top protective disk in plex, usable only with LED bulbs or modules, with surcharge as per price list.

Symbol Index   → • / present - / absent OD / On Demand

CILINDRO

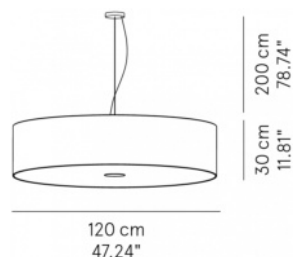
Pendant lamp - ø 120



DESCRIZIONE	SORGENTE			IP	CODICE	
4 lights cotton	4xE27max watt 105 W HES	OD	OD	IP20	CILESP120C01	1.680
4 lights washable	4xE27max watt 105 W HES	OD	OD	IP20	CILESP120T01	1.935
4 lights velvet	4xE27max watt 105 W HES	OD	OD	IP20	CILESP120O01	1.985
4 lights wool	4xE27max watt 105 W HES	OD	OD	IP20	CILESP120E01	1.985
4 lights pleated fabric	4xE27max watt 105 W HES	OD	OD	IP20	CILESP120P01	2.395
4 lights pleated ribbon fabric	4xE27max watt 105 W HES	OD	OD	IP20	CILESP120R01	2.455
1 light cotton NO DIM	1 led module 23 W - 3628 Lm - 2700 K	OD	OD	IP20	CILESP120C08	1.785
1 light washable NO DIM	1 led module 23 W - 3628 Lm - 2700 K	OD	OD	IP20	CILESP120T08	2.040
1 light velvet NO DIM	1 led module 23 W - 3628 Lm - 2700 K	OD	OD	IP20	CILESP120O08	2.090
1 light wool NO DIM	1 led module 23 W - 3628 Lm - 2700 K	OD	OD	IP20	CILESP120E08	2.090
1 light pleated fabric NO DIM	1 led module 23 W - 3628 Lm - 2700 K	OD	OD	IP20	CILESP120P08	2.470
1 light pleated ribbon fabric NO DIM	1 led module 23 W - 3628 Lm - 2700 K	OD	OD	IP20	CILESP120R08	2.535
1 light cotton DIM TRIAC	1 led module 23 W - 3628 Lm - 2700 K	OD	OD	IP20	CILESP120C09	1.860
1 light washable DIM TRIAC	1 led module 23 W - 3628 Lm - 2700 K	OD	OD	IP20	CILESP120T09	2.110
1 light velvet DIM TRIAC	1 led module 23 W - 3628 Lm - 2700 K	OD	OD	IP20	CILESP120O09	2.165
1 light wool DIM TRIAC	1 led module 23 W - 3628 Lm - 2700 K	OD	OD	IP20	CILESP120E09	2.165
1 light pleated fabric DIM TRIAC	1 led module 23 W - 3628 Lm - 2700 K	OD	OD	IP20	CILESP120P09	2.540
1 light pleated ribbon fabric DIM TRIAC	1 led module 23 W - 3628 Lm - 2700 K	OD	OD	IP20	CILESP120R09	2.605
1 light cotton DIM DALI-Push DIM	1 led module 23 W - 3628 Lm - 2700 K	OD	OD	IP20	CILESP120C10	1.860
1 light washable DIM DALI-Push DIM	1 led module 23 W - 3628 Lm - 2700 K	OD	OD	IP20	CILESP120T10	2.110
1 light velvet DIM DALI-Push DIM	1 led module 23 W - 3628 Lm - 2700 K	OD	OD	IP20	CILESP120O10	2.165
1 light wool DIM DALI-Push DIM	1 led module 23 W - 3628 Lm - 2700 K	OD	OD	IP20	CILESP120E10	2.165
1 light pleated fabric DIM DALI-Push DIM	1 led module 23 W - 3628 Lm - 2700 K	OD	OD	IP20	CILESP120P10	2.540
1 light pleated ribbon fabric DIM DALI-Push DIM	1 led module 23 W - 3628 Lm - 2700 K	OD	OD	IP20	CILESP120R10	2.605

PRODUCTS: Cilindro
DESIGN: design: Modoluce R&D 2002



Cylindrical pendant lamp available in cotton, washable, velvet, wool, pleated and pleated ribbon fabrics.
 On demand, lampshade available in For nature and Kvadrat fabrics (with surcharge).
 Opal plex finishing underneath.
 On demand, the pendant lamp can have a top protective disk in plex, usable only with LED bulbs or modules, with surcharge as per price list.

Symbol Index   → • / present - / absent OD / On Demand

CILINDRO

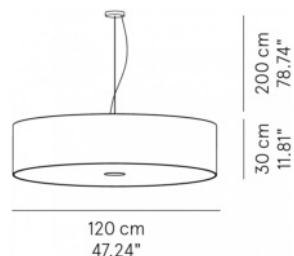
Pendant lamp - ø 120



DESCRIZIONE	SORGENTE			IP	CODICE	
1 light cotton NO DIM	1 led module 88 W - 12380 Lm - 2700 K	OD	OD	IP20	CILESP120C11	1.945
1 light washable NO DIM	1 led module 88 W - 12380 Lm - 2700 K	OD	OD	IP20	CILESP120T11	2.200
1 light velvet NO DIM	1 led module 88 W - 12380 Lm - 2700 K	OD	OD	IP20	CILESP120O11	2.245
1 light wool NO DIM	1 led module 88 W - 12380 Lm - 2700 K	OD	OD	IP20	CILESP120E11	2.245
1 light pleated fabric NO DIM	1 led module 88 W - 12380 Lm - 2700 K	OD	OD	IP20	CILESP120P11	2.730
1 light pleated ribbon fabric NO DIM	1 led module 88 W - 12380 Lm - 2700 K	OD	OD	IP20	CILESP120R11	2.795
1 light cotton DIM DALI-Push DIM	1 led module 88 W - 12380 Lm - 2700 K	OD	OD	IP20	CILESP120C12	1.995
1 light washable DIM DALI-Push DIM	1 led module 88 W - 12380 Lm - 2700 K	OD	OD	IP20	CILESP120T12	2.250
1 light velvet DIM DALI-Push DIM	1 led module 88 W - 12380 Lm - 2700 K	OD	OD	IP20	CILESP120O12	2.300
1 light wool DIM DALI-Push DIM	1 led module 88 W - 12380 Lm - 2700 K	OD	OD	IP20	CILESP120E12	2.300
1 light pleated fabric DIM DALI-Push DIM	1 led module 88 W - 12380 Lm - 2700 K	OD	OD	IP20	CILESP120P12	2.840
1 light pleated ribbon fabric DIM DALI-Push DIM	1 led module 88 W - 12380 Lm - 2700 K	OD	OD	IP20	CILESP120R12	2.905

Accessory

Top protective disk in opal plex	OD	IP20	CILEPX120F01	465
----------------------------------	----	------	--------------	-----

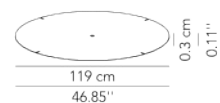

PRODUCTS: Cilindro

DESIGN: design: Modoluce R&D 2002

Cylindrical pendant lamp available in cotton, washable, velvet, wool, pleated and pleated ribbon fabrics.

On demand, lampshade available in For nature and Kvadrat fabrics (with surcharge).

Opal plex finishing underneath.



On demand, the pendant lamp can have a top protective disk in plex, usable only with LED bulbs or modules, with surcharge as per price list.

Symbol Index  → • / present - / absent OD / On Demand

CILINDRO

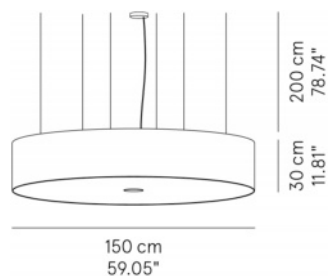
Pendant lamp - ø 150



DESCRIZIONE	SORGENTE			IP	CODICE	
6 lights cotton	6xE27max watt 105 W HES	OD	OD	IP20	CILESP150C01	2.520
6 lights washable	6xE27max watt 105 W HES	OD	OD	IP20	CILESP150T01	2.890
6 lights velvet	6xE27max watt 105 W HES	OD	OD	IP20	CILESP150O01	2.940
6 lights wool	6xE27max watt 105 W HES	OD	OD	IP20	CILESP150E01	2.940
6 lights pleated fabric	6xE27max watt 105 W HES	OD	OD	IP20	CILESP150P01	3.770
6 lights pleated ribbon fabric	6xE27max watt 105 W HES	OD	OD	IP20	CILESP150R01	3.875
1 light cotton NO DIM	1 led module 88 W - 12380 Lm - 2700 K	OD	OD	IP20	CILESP150C08	2.785
1 light washable NO DIM	1 led module 88 W - 12380 Lm - 2700 K	OD	OD	IP20	CILESP150T08	3.150
1 light velvet NO DIM	1 led module 88 W - 12380 Lm - 2700 K	OD	OD	IP20	CILESP150O08	3.205
1 light wool NO DIM	1 led module 88 W - 12380 Lm - 2700 K	OD	OD	IP20	CILESP150E08	3.205
1 light pleated fabric NO DIM	1 led module 88 W - 12380 Lm - 2700 K	OD	OD	IP20	CILESP150P08	3.975
1 light pleated ribbon fabric NO DIM	1 led module 88 W - 12380 Lm - 2700 K	OD	OD	IP20	CILESP150R08	4.085
1 light cotton DIM DALI-Push DIM	1 led module 88 W - 12380 Lm - 2700 K	OD	OD	IP20	CILESP150C09	2.835
1 light washable DIM DALI-Push DIM	1 led module 88 W - 12380 Lm - 2700 K	OD	OD	IP20	CILESP150T09	3.205
1 light velvet DIM DALI-Push DIM	1 led module 88 W - 12380 Lm - 2700 K	OD	OD	IP20	CILESP150O09	3.255
1 light wool DIM DALI-Push DIM	1 led module 88 W - 12380 Lm - 2700 K	OD	OD	IP20	CILESP150E09	3.255
1 light pleated fabric DIM DALI-Push DIM	1 led module 88 W - 12380 Lm - 2700 K	OD	OD	IP20	CILESP150P09	4.085
1 light pleated ribbon fabric DIM DALI-Push DIM	1 led module 88 W - 12380 Lm - 2700 K	OD	OD	IP20	CILESP150R09	4.195

NOTE: on demand, LED modules are also available in 3000K and 4000K, without surcharge.

-

0

PRODUCTS: Cilindro



DESIGN: design: Modoluce R&D 2002

Cylindrical pendant lamp available in cotton, washable, velvet, wool, pleated and pleated ribbon fabrics.

On demand, lampshade available in For nature and Kvadrat fabrics (with surcharge).

Opal plex finishing underneath.

On demand, the pendant lamp can have a top protective disk in plex, usable only with LED bulbs or modules, with surcharge as per price list.



Symbol Index   → • / present - / absent OD / On Demand

CILINDRO

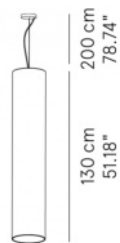
Pendant lamp - ø 25



25 cm
9.84"

DESCRIZIONE	SORGENTE			IP	CODICE	
1 light cotton	1xE27max watt 105 W HES	OD	OD	IP20	LOSESO130C01	530
1 light washable	1xE27max watt 105 W HES	OD	OD	IP20	LOSESO130T01	720
1 light velvet	1xE27max watt 105 W HES	OD	OD	IP20	LOSESO130O01	775
1 light wool	1xE27max watt 105 W HES	OD	OD	IP20	LOSESO130E01	775
6 lights cotton	6xE27max watt 28 W HES	OD	OD	IP20	LOSESO130C02	760
6 lights washable	6xE27max watt 28 W HES	OD	OD	IP20	LOSESO130T02	950
6 lights velvet	6xE27max watt 28 W HES	OD	OD	IP20	LOSESO130O02	1.010
6 lights wool	6xE27max watt 28 W HES	OD	OD	IP20	LOSESO130E02	1.010

PRODUCTS: Circus

DESIGN: design: Modoluce R&D 2018

Cylindrical or elliptical pendant lamp certified in acoustic comfort in velvet, wool, For nature and Kvadrat fabrics.

On demand, lampshade available in cubic fabric (with surcharge). Opal plex finishing underneath.

On demand, pendant lamps (Circus Longue excluded) can have a top protective disk in plex (on demand), usable only with LED bulbs or modules, with surcharge as per price list.

Double light emission as standard for Circus Longue: L 130 up 2690 lm down 5380 lm - L 160 up 2690 lm down 6720 lm.

Symbol Index  → • / present - / absent OD / On Demand

CIRCUS

Pendant lamp - ø 50

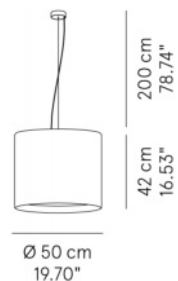

DESCRIZIONE	SORGENTE			IP	CODICE	
3 lights velvet	3xE27max watt 70 W HES	OD	OD	IP20	CISESP050O02	1.910
3 lights wool	3xE27max watt 70 W HES	OD	OD	IP20	CISESP050E02	1.910
3 lights For nature	3xE27max watt 70 W HES	OD	OD	IP20	CISESP050Q02	2.020
3 lights Kvadrat	3xE27max watt 70 W HES	OD	OD	IP20	CISESP050I02	2.085
1 light velvet NO DIM	1 led module 23 W - 3628 Lm - 2700 K	OD	OD	IP20	CISESP050O03	2.075
1 light wool NO DIM	1 led module 23 W - 3628 Lm - 2700 K	OD	OD	IP20	CISESP050E03	2.075
1 light For nature NO DIM	1 led module 23 W - 3628 Lm - 2700 K	OD	OD	IP20	CISESP050Q03	2.185
1 light Kvadrat NO DIM	1 led module 23 W - 3628 Lm - 2700 K	OD	OD	IP20	CISESP050I03	2.245
1 light velvet DIM TRIAC	1 led module 23 W - 3628 Lm - 2700 K	OD	OD	IP20	CISESP050O04	2.130
1 light wool DIM TRIAC	1 led module 23 W - 3628 Lm - 2700 K	OD	OD	IP20	CISESP050E04	2.130
1 light For nature DIM TRIAC	1 led module 23 W - 3628 Lm - 2700 K	OD	OD	IP20	CISESP050Q04	2.235
1 light Kvadrat DIM TRIAC	1 led module 23 W - 3628 Lm - 2700 K	OD	OD	IP20	CISESP050I04	2.305
1 light velvet DIM DALI-Push DIM	1 led module 23 W - 3628 Lm - 2700 K	OD	OD	IP20	CISESP050O05	2.130
1 light wool DIM DALI-Push DIM	1 led module 23 W - 3628 Lm - 2700 K	OD	OD	IP20	CISESP050E05	2.130
1 light For nature DIM DALI-Push DIM	1 led module 23 W - 3628 Lm - 2700 K	OD	OD	IP20	CISESP050Q05	2.235
1 light Kvadrat DIM DALI-Push DIM	1 led module 23 W - 3628 Lm - 2700 K	OD	OD	IP20	CISESP050I05	2.305

Accessory

Top protective disk in opal plex (montato)	OD	IP20	CISEPX050F01	175
--	----	------	--------------	-----

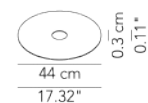

PRODUCTS: Circus

DESIGN: design: Modoluce R&D 2018

Cylindrical or elliptical pendant lamp certified in acoustic comfort in velvet, wool, For nature and Kvadrat fabrics.

On demand, lampshade available in cubic fabric (with surcharge). Opal plex finishing underneath.

On demand, pendant lamps (Circus Longue excluded) can have a top protective disk in plex (on demand), usable only with LED bulbs or modules, with surcharge as per price list.



Double light emission as standard for Circus Longue: L 130 up 2690 lm down 5380 lm - L 160 up 2690 lm down 6720 lm.

Symbol Index  → • / present - / absent OD / On Demand

CIRCUS

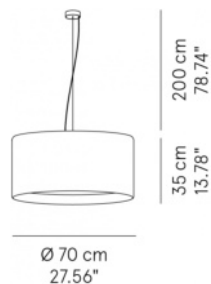
Pendant lamp - ø 70



DESCRIZIONE	SORGENTE			IP	CODICE	
3 lights velvet	3xE27max watt 70 W HES	OD	OD	IP20	CISESP070O02	2.300
3 lights wool	3xE27max watt 70 W HES	OD	OD	IP20	CISESP070E02	2.300
3 lights For nature	3xE27max watt 70 W HES	OD	OD	IP20	CISESP070Q02	2.420
3 lights Kvadrat	3xE27max watt 70 W HES	OD	OD	IP20	CISESP070I02	2.500
1 light velvet NO DIM	1 led module 23 W - 3628 Lm - 2700 K	OD	OD	IP20	CISESP070O03	2.500
1 light wool NO DIM	1 led module 23 W - 3628 Lm - 2700 K	OD	OD	IP20	CISESP070E03	2.500
1 light For nature NO DIM	1 led module 23 W - 3628 Lm - 2700 K	OD	OD	IP20	CISESP070Q03	2.620
1 light Kvadrat NO DIM	1 led module 23 W - 3628 Lm - 2700 K	OD	OD	IP20	CISESP070I03	2.700
1 light velvet DIM TRIAC	1 led module 23 W - 3628 Lm - 2700 K	OD	OD	IP20	CISESP070O04	2.595
1 light wool DIM TRIAC	1 led module 23 W - 3628 Lm - 2700 K	OD	OD	IP20	CISESP070E04	2.595
1 light For nature DIM TRIAC	1 led module 23 W - 3628 Lm - 2700 K	OD	OD	IP20	CISESP070Q04	2.715
1 light Kvadrat DIM TRIAC	1 led module 23 W - 3628 Lm - 2700 K	OD	OD	IP20	CISESP070I04	2.795
1 light velvet DIM DALI-Push DIM	1 led module 23 W - 3628 Lm - 2700 K	OD	OD	IP20	CISESP070O05	2.595
1 light wool DIM DALI-Push DIM	1 led module 23 W - 3628 Lm - 2700 K	OD	OD	IP20	CISESP070E05	2.595
1 light For nature DIM DALI-Push DIM	1 led module 23 W - 3628 Lm - 2700 K	OD	OD	IP20	CISESP070Q05	2.715
1 light Kvadrat DIM DALI-Push DIM	1 led module 23 W - 3628 Lm - 2700 K	OD	OD	IP20	CISESP070I05	2.795

Accessory	Top protective disk in opal plex (montato)	OD		IP20	CISEPX070F01	175
------------------	--	----	--	------	--------------	-----

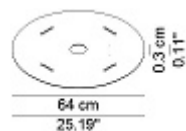

PRODUCTS: Circus**DESIGN:** design: Modoluce R&D 2018



Cylindrical or elliptical pendant lamp certified in acoustic comfort in velvet, wool, For nature and Kvadrat fabrics.

On demand, lampshade available in cubic fabric (with surcharge). Opal plex finishing underneath.

On demand, pendant lamps (Circus Longue excluded) can have a top protective disk in plex (on demand), usable only with LED bulbs or modules, with surcharge as per price list.

Double light emission as standard for Circus Longue: L 130 up 2690 lm down 5380 lm - L 160 up 2690 lm down 6720 lm.

Symbol Index  → • / present - / absent OD / On Demand**CIRCUS****Pendant lamp - ø 100**

DESCRIZIONE	SORGENTE			IP	CODICE	
4 lights velvet	4xE27max watt 105 W HES	OD	OD	IP20	CISESP100O02	2.825
4 lights wool	4xE27max watt 105 W HES	OD	OD	IP20	CISESP100E02	2.825
4 lights For nature	4xE27max watt 105 W HES	OD	OD	IP20	CISESP100Q02	2.995
4 lights Kvadrat	4xE27max watt 105 W HES	OD	OD	IP20	CISESP100I02	3.100
1 light velvet NO DIM	1 led module 23 W - 3628 Lm - 2700 K	OD	OD	IP20	CISESP100O03	2.950
1 light wool NO DIM	1 led module 23 W - 3628 Lm - 2700 K	OD	OD	IP20	CISESP100E03	2.950
1 light For nature NO DIM	1 led module 23 W - 3628 Lm - 2700 K	OD	OD	IP20	CISESP100Q03	3.120
1 light Kvadrat NO DIM	1 led module 23 W - 3628 Lm - 2700 K	OD	OD	IP20	CISESP100I03	3.225
1 light velvet DIM TRIAC	1 led module 23 W - 3628 Lm - 2700 K	OD	OD	IP20	CISESP100O04	3.025
1 light wool DIM TRIAC	1 led module 23 W - 3628 Lm - 2700 K	OD	OD	IP20	CISESP100E04	3.025
1 light For nature DIM TRIAC	1 led module 23 W - 3628 Lm - 2700 K	OD	OD	IP20	CISESP100Q04	3.190
1 light Kvadrat DIM TRIAC	1 led module 23 W - 3628 Lm - 2700 K	OD	OD	IP20	CISESP100I04	3.295
1 light velvet DIM DALI - Push DIM	1 led module 23 W - 3628 Lm - 2700 K	OD	OD	IP20	CISESP100O05	3.025
1 light wool DIM DALI - Push DIM	1 led module 23 W - 3628 Lm - 2700 K	OD	OD	IP20	CISESP100E05	3.025
1 light For nature DIM DALI - Push DIM	1 led module 23 W - 3628 Lm - 2700 K	OD	OD	IP20	CISESP100Q05	3.190
1 light Kvadrat DIM DALI - Push DIM	1 led module 23 W - 3628 Lm - 2700 K	OD	OD	IP20	CISESP100I05	3.295
1 light velvet NO DIM	1 led module 57 W - 8750 Lm - 2700 K	OD	OD	IP20	CISESP100O08	3.055
1 light wool NO DIM	1 led module 57 W - 8750 Lm - 2700 K	OD	OD	IP20	CISESP100E08	3.055
1 light For nature NO DIM	1 led module 57 W - 8750 Lm - 2700 K	OD	OD	IP20	CISESP100Q08	3.225
1 light Kvadrat NO DIM	1 led module 57 W - 8750 Lm - 2700 K	OD	OD	IP20	CISESP100I08	3.330
1 light velvet DIM TRIAC	1 led module 57 W - 8750 Lm - 2700 K	OD	OD	IP20	CISESP100O09	3.130
1 light wool DIM TRIAC	1 led module 57 W - 8750 Lm - 2700 K	OD	OD	IP20	CISESP100E09	3.130
1 light For nature DIM TRIAC	1 led module 57 W - 8750 Lm - 2700 K	OD	OD	IP20	CISESP100Q09	3.295
1 light Kvadrat DIM TRIAC	1 led module 57 W - 8750 Lm - 2700 K	OD	OD	IP20	CISESP100I09	3.400

PRODUCTS: Circus



DESIGN: design: Modoluce R&D 2018

Cylindrical or elliptical pendant lamp certified in acoustic comfort in velvet, wool, For nature and Kvadrat fabrics.

On demand, lampshade available in cubic fabric (with surcharge). Opal plex finishing underneath.

On demand, pendant lamps (Circus Longue excluded) can have a top protective disk in plex (on demand), usable only with LED bulbs or modules, with surcharge as per price list.

Double light emission as standard for Circus Longue: L 130 up 2690 lm down 5380 lm - L 160 up 2690 lm down 6720 lm.

Symbol Index   → • / present - / absent OD / On Demand

CIRCUS

DESCRIZIONE

SORGENTE



IP

CODICE

Pendant lamp - ø 100

1 light velvet DIM DALI-Push DIM

1 led module 57 W - 8750 Lm - 2700 K

OD

OD

IP20

CISESP100O10

3.130

1 light wool DIM DALI-Push DIM

1 led module 57 W - 8750 Lm - 2700 K

OD

OD

IP20

CISESP100E10

3.130

1 light For nature DIM DALI-Push DIM

1 led module 57 W - 8750 Lm - 2700 K

OD

OD

IP20

CISESP100Q10

3.295

1 light Kvadrat DIM DALI-Push DIM

1 led module 57 W - 8750 Lm - 2700 K

OD

OD

IP20

CISESP100H10

3.400



Accessory

Top protective disk in opal plex (montato)

OD

IP20

CISEPX100F01

315

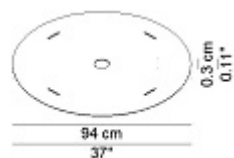

PRODUCTS: Circus

DESIGN: design: Modoluce R&D 2018

Cylindrical or elliptical pendant lamp certified in acoustic comfort in velvet, wool, For nature and Kvadrat fabrics.

On demand, lampshade available in cubic fabric (with surcharge). Opal plex finishing underneath.

On demand, pendant lamps (Circus Longue excluded) can have a top protective disk in plex (on demand), usable only with LED bulbs or modules, with surcharge as per price list.



Double light emission as standard for Circus Longue: L 130 up 2690 lm down 5380 lm - L 160 up 2690 lm down 6720 lm.

Symbol Index  → • / present - / adsent OD / On Demand

CIRCUS

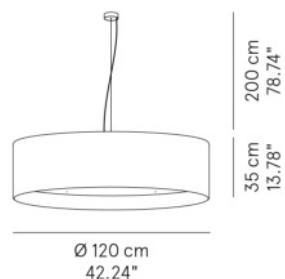
Pendant lamp - ø 120



DESCRIZIONE	SORGENTE			IP	CODICE	
4 lights velvet	4xE27max watt 105 W HES	OD	OD	IP20	CISESP120O02	3.145
4 lights wool	4xE27max watt 105 W HES	OD	OD	IP20	CISESP120E02	3.145
4 lights For nature	4xE27max watt 105 W HES	OD	OD	IP20	CISESP120Q02	3.345
4 lights Kvadrat	4xE27max watt 105 W HES	OD	OD	IP20	CISESP120I02	3.475
1 light velvet NO DIM	1 led module 23 W - 3628 Lm - 2700 K	OD	OD	IP20	CISESP120O03	3.285
1 light wool NO DIM	1 led module 23 W - 3628 Lm - 2700 K	OD	OD	IP20	CISESP120E03	3.285
1 light For nature NO DIM	1 led module 23 W - 3628 Lm - 2700 K	OD	OD	IP20	CISESP120Q03	3.485
1 light Kvadrat NO DIM	1 led module 23 W - 3628 Lm - 2700 K	OD	OD	IP20	CISESP120I03	3.615
1 light velvet DIM TRIAC	1 led module 23 W - 3628 Lm - 2700 K	OD	OD	IP20	CISESP120O04	3.360
1 light wool DIM TRIAC	1 led module 23 W - 3628 Lm - 2700 K	OD	OD	IP20	CISESP120E04	3.360
1 light For nature DIM TRIAC	1 led module 23 W - 3628 Lm - 2700 K	OD	OD	IP20	CISESP120Q04	3.560
1 light Kvadrat DIM TRIAC	1 led module 23 W - 3628 Lm - 2700 K	OD	OD	IP20	CISESP120I04	3.690
1 light velvet DIM DALI-Push DIM	1 led module 23 W - 3628 Lm - 2700 K	OD	OD	IP20	CISESP120O05	3.360
1 light wool DIM DALI-Push DIM	1 led module 23 W - 3628 Lm - 2700 K	OD	OD	IP20	CISESP120E05	3.360
1 light For nature DIM DALI-Push DIM	1 led module 23 W - 3628 Lm - 2700 K	OD	OD	IP20	CISESP120Q05	3.560
1 light Kvadrat DIM DALI-Push DIM	1 led module 23 W - 3628 Lm - 2700 K	OD	OD	IP20	CISESP120I05	3.690
1 light velvet NO DIM	1 led module 88 W - 12380 Lm - 2700 K	OD	OD	IP20	CISESP120O06	3.425
1 light wool NO DIM	1 led module 88 W - 12380 Lm - 2700 K	OD	OD	IP20	CISESP120E06	3.425
1 light For nature NO DIM	1 led module 88 W - 12380 Lm - 2700 K	OD	OD	IP20	CISESP120Q06	3.625
1 light Kvadrat NO DIM	1 led module 88 W - 12380 Lm - 2700 K	OD	OD	IP20	CISESP120I06	3.755
1 light velvet DIM DALI-Push DIM	1 led module 88 W - 12380 Lm - 2700 K	OD	OD	IP20	CISESP120O07	3.490
1 light wool DIM DALI-Push DIM	1 led module 88 W - 12380 Lm - 2700 K	OD	OD	IP20	CISESP120E07	3.490
1 light For nature DIM DALI-Push DIM	1 led module 88 W - 12380 Lm - 2700 K	OD	OD	IP20	CISESP120Q07	3.690
1 light Kvadrat DIM DALI-Push DIM	1 led module 88 W - 12380 Lm - 2700 K	OD	OD	IP20	CISESP120I07	3.820

PRODUCTS: Circus

DESIGN: design: Modoluce R&D 2018

Cylindrical or elliptical pendant lamp certified in acoustic comfort in velvet, wool, For nature and Kvadrat fabrics.

On demand, lampshade available in cubic fabric (with surcharge). Opal plex finishing underneath.

On demand, pendant lamps (Circus Longue excluded) can have a top protective disk in plex (on demand), usable only with LED bulbs or modules, with surcharge as per price list.

Double light emission as standard for Circus Longue: L 130 up 2690 lm down 5380 lm - L 160 up 2690 lm down 6720 lm.

Symbol Index  → • / present - / absent OD / On Demand

CIRCUS

DESCRIZIONE

SORGENTE



IP

CODICE

Accessory

Top protective disk in opal plex (montato)

OD IP20 CISEPX120F01 385

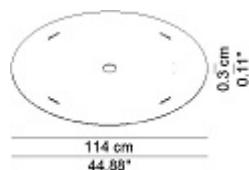

Pendant lamp - ø 150



6 lights velvet	6xE27max watt 105 W HES	OD	OD	IP20	CISESP150O02	5.410
6 lights wool	6xE27max watt 105 W HES	OD	OD	IP20	CISESP150E02	5.410
6 lights For nature	6xE27max watt 105 W HES	OD	OD	IP20	CISESP150Q02	5.740
6 lights Kvadrat	6xE27max watt 105 W HES	OD	OD	IP20	CISESP150I02	5.960
1 light velvet NO DIM	1 led module 88 W - 12380 Lm - 2700 K	OD	OD	IP20	CISESP150O06	5.565
1 light wool NO DIM	1 led module 88 W - 12380 Lm - 2700 K	OD	OD	IP20	CISESP150E06	5.565
1 light For nature NO DIM	1 led module 88 W - 12380 Lm - 2700 K	OD	OD	IP20	CISESP150Q06	5.895
1 light Kvadrat NO DIM	1 led module 88 W - 12380 Lm - 2700 K	OD	OD	IP20	CISESP150I06	6.115
1 light velvet DIM DALI-Push DIM	1 led module 88 W - 12380 Lm - 2700 K	OD	OD	IP20	CISESP150O07	5.635
1 light wool DIM DALI-Push DIM	1 led module 88 W - 12380 Lm - 2700 K	OD	OD	IP20	CISESP150E07	5.635
1 light For nature DIM DALI-Push DIM	1 led module 88 W - 12380 Lm - 2700 K	OD	OD	IP20	CISESP150Q07	5.965
1 light Kvadrat DIM DALI-Push DIM	1 led module 88 W - 12380 Lm - 2700 K	OD	OD	IP20	CISESP150I07	6.185

NOTE: on demand, LED modules are also available in 3000K and 4000K, without surcharge.

- 0

PRODUCTS: Circus

DESIGN: design: Modoluce R&D 2018

Cylindrical or elliptical pendant lamp certified in acoustic comfort in velvet, wool, For nature and Kvadrat fabrics.

On demand, lampshade available in cubic fabric (with surcharge). Opal plex finishing underneath.

On demand, pendant lamps (Circus Longue excluded) can have a top protective disk in plex (on demand), usable only with LED bulbs or modules, with surcharge as per price list.



Double light emission as standard for Circus Longue: L 130 up 2690 lm down 5380 lm - L 160 up 2690 lm down 6720 lm.

Symbol Index  → • / present - / adsent OD / On Demand

CIRCUS

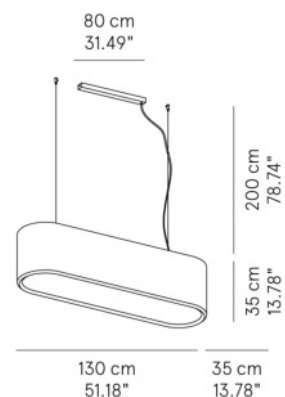
Circus Longue - L 130



DESCRIZIONE	SORGENTE			IP	CODICE	
Velvet NO DIM	2 linear modules 48 W - 8070 Lm - 3000 K	•	OD	IP20	CLOESO130O01	2.835
Wool NO DIM	2 linear modules 48 W - 8070 Lm - 3000 K	•	OD	IP20	CLOESO130E01	2.835
For nature NO DIM	2 linear modules 48 W - 8070 Lm - 3000 K	•	OD	IP20	CLOESO130Q01	3.075
Kvadrat NO DIM	2 linear modules 48 W - 8070 Lm - 3000 K	•	OD	IP20	CLOESO130I01	3.215
Velvet DIM DALI-Push DIM	2 linear modules 48 W - 8070 Lm - 3000 K	•	OD	IP20	CLOESO130O02	2.890
Wool DIM DALI-Push DIM	2 linear modules 48 W - 8070 Lm - 3000 K	•	OD	IP20	CLOESO130E02	2.890
For nature DIM DALI-Push DIM	2 linear modules 48 W - 8070 Lm - 3000 K	•	OD	IP20	CLOESO130Q02	3.130
Kvadrat DIM DALI-Push DIM	2 linear modules 48 W - 8070 Lm - 3000 K	•	OD	IP20	CLOESO130I02	3.265

Circus Longue - L 160

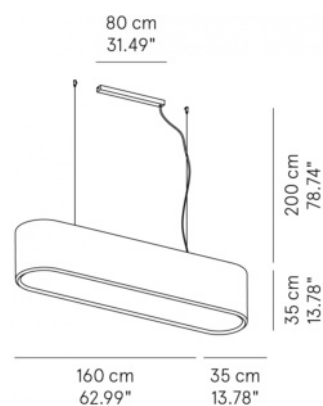

Velvet NO DIM	2 linear modules 48 W - 8070 Lm - 3000 K	•	OD	IP20	CLOESO160O01	3.360
Wool NO DIM	2 linear modules 48 W - 8070 Lm - 3000 K	•	OD	IP20	CLOESO160E01	3.360
For nature NO DIM	2 linear modules 48 W - 8070 Lm - 3000 K	•	OD	IP20	CLOESO160Q01	3.600
Kvadrat NO DIM	2 linear modules 48 W - 8070 Lm - 3000 K	•	OD	IP20	CLOESO160I01	3.740
Velvet DIM DALI-Push DIM	2 linear modules 56 W - 9410 Lm - 3000 K	•	OD	IP20	CLOESO160O02	3.415
Wool DIM DALI-Push DIM	2 linear modules 56 W - 9410 Lm - 3000 K	•	OD	IP20	CLOESO160E02	3.415
For nature DIM DALI-Push DIM	2 linear modules 56 W - 9410 Lm - 3000 K	•	OD	IP20	CLOESO160Q02	3.655
Kvadrat DIM DALI-Push DIM	2 linear modules 56 W - 9410 Lm - 3000 K	•	OD	IP20	CLOESO160I02	3.895

PRODUCTS: Clip**DESIGN:** design: Baldessari e Baldessari 2018

Oblong shape pendant lamp with double light emission. Metal structure painted white or lead grey and in Deluxe finishing matt gold.

Upper diffuser in white polycarbonate.

Double light emission: L 130 Up 5120 lm - Down 2560 lm / L 170 Up 7040 lm - Down 2560 lm

Symbol Index  → • / present - / absent OD / On Demand**CLIP****DESCRIZIONE****SORGENTE****IP****CODICE****Pendant lamp - L 130**

Pendant lamp white or lead grey NO DIM

2 linear modules 48 W - 8070 Lm - 3000 K

• OD IP20 CLIESO130G01 2.295

Pendant lamp white or lead grey DIM DALI/Push DIM

2 linear modules 48 W - 8070 Lm - 3000 K

• OD IP20 CLIESO130G03 2.335

Pendant lamp Deluxe NO DIM

2 linear modules 48 W - 8070 Lm - 3000 K

• OD IP20 CLIESO130G02 2.405

Pendant lamp Deluxe DIM DALI/Push DIM

2 linear modules 48 W - 8070 Lm - 3000 K

• OD IP20 CLIESO130G04 2.445

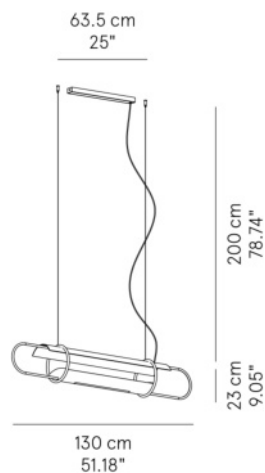



PRODUCTS: Clip**DESIGN:** design: Baldessari e Baldessari 2018

Oblong shape pendant lamp with double light emission. Metal structure painted white or lead grey and in Deluxe finishing matt gold.

Upper diffuser in white polycarbonate.

Double light emission: L 130 Up 5120 lm - Down 2560 lm / L 170 Up 7040 lm - Down 2560 lm

Symbol Index   → • / present - / absent OD / On Demand**CLIP****DESCRIZIONE****SORGENTE****IP****CODICE****Pendant lamp - L 170**

Pendant lamp white or lead grey NO DIM

2 linear modules 60 W - 9600 Lm - 3000 K - >80

• OD IP20 CLIESO170G01 2.565

Pendant lamp white or lead grey DIM DALI/Push DIM

2 linear modules 60 W - 9600 Lm - 3000 K - >80

• OD IP20 CLIESO170G03 2.680

Pendant lamp Deluxe NO DIM

2 linear modules 60 W - 9600 Lm - 3000 K - >80

• OD IP20 CLIESO170G02 2.680

Pendant lamp Deluxe DIM DALI/Push DIM

2 linear modules 60 W - 9600 Lm - 3000 K - >80

• OD IP20 CLIESO170G04 2.785

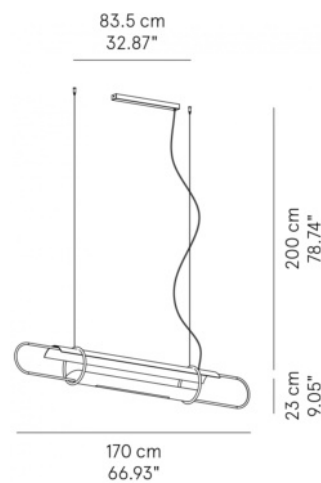

PRODUCTS: Cocò

DESIGN: design: Brian Rasmussen 2015

Pendant lamp in hand-finished pleated fabric.

Opal plex finishing underneath.

Symbol Index  → • / present - / adsent OD / On Demand

COCÒ

Pendant lamp D.60



30 cm
11.81"

60 cm
23.62"

200 cm
78.74"

32 cm
12.59"

DESCRIZIONE

SORGENTE



IP

CODICE

Pendant lamp pleated fabric

2xE27max watt 42 W HES

OD

OD

IP20

COCESP060P01

1.190

Pendant lamp pleated fabric NO DIM

1 led module 18 W - 3000 Lm - 2700 K

OD

OD

IP20

COCESP060P05

1.315

Pendant lamp pleated fabric DIM TRIAC

1 led module 18 W - 3000 Lm - 2700 K

OD

OD

IP20

COCESP060P07

1.335

Pendant lamp pleated fabric DIM DALI-Push DIM

1 led module 18 W - 3000 Lm - 2700 K

OD

OD

IP20

COCESP060P06

1.420

Pendant lamp D.80

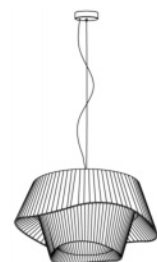

40 cm
15.74"

80 cm
31.49"

200 cm
78.74"

43 cm
16.92"

Pendant lamp pleated fabric

3xE27max watt 70 W HES

OD

OD

IP20

COCESP080P01

1.690

Pendant lamp pleated fabric NO DIM

1 led module 23 W - 3628 Lm - 2700 K

OD

OD

IP20

COCESP080P05

1.910

Pendant lamp pleated fabric DIM TRIAC

1 led module 23 W - 3628 Lm - 2700 K

OD

OD

IP20

COCESP080P07

1.990

Pendant lamp pleated fabric DIM DALI-Push DIM

1 led module 23 W - 3628 Lm - 2700 K

OD

OD

IP20

COCESP080P06

1.990

PRODUCTS: Cocò

DESIGN: design: Brian Rasmussen 2015

Pendant lamp in hand-finished pleated fabric.

Opal plex finishing underneath.

Symbol Index  → • / present - / adsent OD / On Demand

COCÒ

Pendant lamp D.100

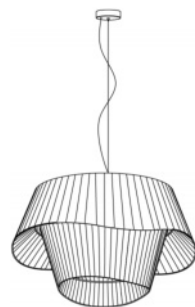



200 cm
78.74"

54 cm
21.26"

50 cm
19.69"

100 cm
39.37"



DESCRIZIONE	SORGENTE			IP	CODICE	
Pendant lamp pleated fabric	4xE27max watt 70 W HES	OD	OD	IP20	COCESP100P01	2.235
Pendant lamp pleated fabric NO DIM	1 led module 23 W - 3628 Lm - 2700 K	OD	OD	IP20	COCESP100P05	2.405
Pendant lamp pleated fabric DIM TRIAC	1 led module 23 W - 3628 Lm - 2700 K	OD	OD	IP20	COCESP100P09	2.480
Pendant lamp pleated fabric DIM DALI-Push DIM	1 led module 23 W - 3628 Lm - 2700 K	OD	OD	IP20	COCESP100P06	2.480
Pendant lamp pleated fabric NO DIM	1 led module 57 W - 8750 Lm - 2700 K	OD	OD	IP20	COCESP100P12	2.620
Pendant lamp pleated fabric DIM TRIAC	1 led module 57 W - 8750 Lm - 2700 K	OD	OD	IP20	COCESP100P13	2.700
Pendant lamp pleated fabric DIM DALI-Push DIM	1 led module 57 W - 8750 Lm - 2700 K	OD	OD	IP20	COCESP100P14	2.730

PRODUCTS: Cocò

DESIGN: design: Brian Rasmussen 2015

Pendant lamp in hand-finished pleated fabric.

Opal plex finishing underneath.

Symbol Index   → • / present - / adsent OD / On Demand

COCÒ

DESCRIZIONE

SORGENTE



IP

CODICE

Pendant lamp D.150

Pendant lamp pleated fabric NO DIM

1 led module 88 W - 12380 Lm - 2700 K

OD OD IP20 COCESP150P02 4.860

Pendant lamp pleated fabric DIM DALI-Push DIM

1 led module 88 W - 12380 Lm - 2700 K

OD OD IP20 COCESP150P03 4.965

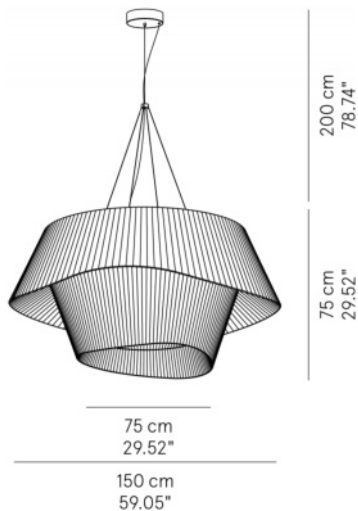



NOTE: on demand, LED modules are also available in 3000K and 4000K, without surcharge.

PRODUCTS: Cocò Demi

DESIGN: design: Brian Rasmussen 2024

Pendant lamp in hand-finished pleated fabric.

Opal plex finishing underneath.

Symbol Index   → • / present - / adsent OD / On Demand

COCÒ DEMI

Pendant lamp D.60

DESCRIZIONE

SORGENTE



IP

CODICE

Pendant lamp pleated fabric

2xE27max watt 42 W HES

OD

OD

IP20

CODESP060P01

920



Pendant lamp pleated fabric NO DIM

1 led module 18 W - 3000 Lm - 2700 K

OD

OD

IP20

CODESP060P05

1.040

Pendant lamp pleated fabric DIM TRIAC

1 led module 18 W - 3000 Lm - 2700 K

OD

OD

IP20

CODESP060P07

1.060

Pendant lamp pleated fabric DIM DALI-Push DIM

1 led module 18 W - 3000 Lm - 2700 K

OD

OD

IP20

CODESP060P06

1.145

Pendant lamp D.80

Pendant lamp pleated fabric

3xE27max watt 70 W HES

OD

OD

IP20

CODESP080P01

1.255



Pendant lamp pleated fabric NO DIM

1 led module 23 W - 3628 Lm - 2700 K

OD

OD

IP20

CODESP080P05

1.475

Pendant lamp pleated fabric DIM TRIAC

1 led module 23 W - 3628 Lm - 2700 K

OD

OD

IP20

CODESP080P07

1.550

Pendant lamp pleated fabric DIM DALI-Push DIM

1 led module 23 W - 3628 Lm - 2700 K

OD

OD

IP20

CODESP080P06

1.550

PRODUCTS: Cocò Demi
DESIGN: design: Brian Rasmussen 2024

Pendant lamp in hand-finished pleated fabric.
 Opal plex finishing underneath.

Symbol Index  → • / present - / adsent OD / On Demand

COCÒ DEMI

Pendant lamp D.100

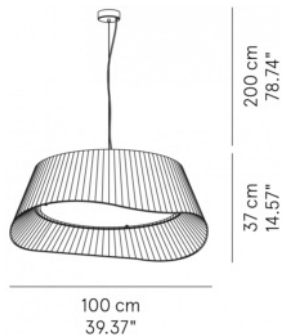

DESCRIZIONE	SORGENTE			IP	CODICE	
Pendant lamp pleated fabric	4xE27max watt 70 W HES	OD	OD	IP20	CODESP100P01	1.585
Pendant lamp pleated fabric NO DIM	1 led module 23 W - 3628 Lm - 2700 K	OD	OD	IP20	CODESP100P05	1.750
Pendant lamp pleated fabric DIM TRIAC	1 led module 23 W - 3628 Lm - 2700 K	OD	OD	IP20	CODESP100P09	1.820
Pendant lamp pleated fabric DIM DALI-Push DIM	1 led module 23 W - 3628 Lm - 2700 K	OD	OD	IP20	CODESP100P06	1.820
Pendant lamp pleated fabric NO DIM	1 led module 57 W - 8750 Lm - 2700 K	OD	OD	IP20	CODESP100P12	1.965
Pendant lamp pleated fabric DIM TRIAC	1 led module 57 W - 8750 Lm - 2700 K	OD	OD	IP20	CODESP100P13	2.040
Pendant lamp pleated fabric DIM DALI-Push DIM	1 led module 57 W - 8750 Lm - 2700 K	OD	OD	IP20	CODESP100P14	2.040

Pendant lamp D.150

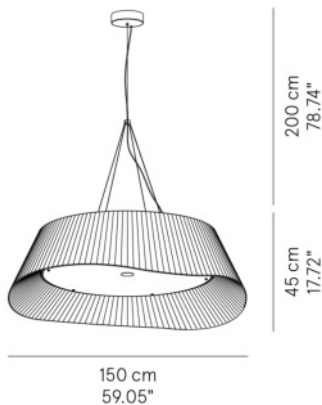

Pendant lamp pleated fabric NO DIM	1 led module 88 W - 12380 Lm - 2700 K	OD	OD	IP20	CODESP150P02	3.770
Pendant lamp pleated fabric DIM DALI-Push DIM	1 led module 88 W - 12380 Lm - 2700 K	OD	OD	IP20	CODESP150P03	3.875

PRODUCTS: Cocò Demi
DESIGN: design: Brian Rasmussen 2024

Pendant lamp in hand-finished pleated fabric.
 Opal plex finishing underneath.

Symbol Index  → • / present - / adsent OD / On Demand

COCÒ DEMI

Ceiling lamp D.60

DESCRIZIONE

SORGENTE



IP

CODICE

Ceiling lamp pleated fabric

2xE27max watt 42 W HES

OD OD IP20 CODEPL060P01 900



23 cm
9.06"

60 cm
23.62"

Ceiling lamp pleated fabric NO DIM

1 led module 18 W - 3000 Lm - 2700 K

OD OD IP20 CODEPL060P05 970

Ceiling lamp pleated fabric DIM TRIAC

1 led module 18 W - 3000 Lm - 2700 K

OD OD IP20 CODEPL060P07 990

Ceiling lamp pleated fabric DIM DALI-Push DIM

1 led module 18 W - 3000 Lm - 2700 K

OD OD IP20 CODEPL060P06 1.050

Ceiling lamp D.80

Ceiling lamp pleated fabric

3xE27max watt 70 W HES

OD OD IP20 CODEPL080P01 1.190



31 cm
12.24"

80 cm
31.49"

Ceiling lamp pleated fabric NO DIM

1 led module 23 W - 3628 Lm - 2700 K

OD OD IP20 CODEPL080P05 1.315

Ceiling lamp pleated fabric DIM TRIAC

1 led module 23 W - 3628 Lm - 2700 K

OD OD IP20 CODEPL080P07 1.385

Ceiling lamp pleated fabric DIM DALI-Push DIM

1 led module 23 W - 3628 Lm - 2700 K

OD OD IP20 CODEPL080P06 1.395

Ceiling lamp D.100

Ceiling lamp pleated fabric

4xE27max watt 70 W HES

OD OD IP20 CODEPL100P01 1.690

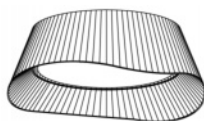

38 cm
14.96"

100 cm
39.37"

Ceiling lamp pleated fabric NO DIM

1 led module 23 W - 3628 Lm - 2700 K

OD OD IP20 CODEPL100P05 1.640

Ceiling lamp pleated fabric DIM TRIAC

1 led module 23 W - 3628 Lm - 2700 K

OD OD IP20 CODEPL100P09 1.760

Ceiling lamp pleated fabric DIM DALI-Push DIM

1 led module 23 W - 3628 Lm - 2700 K

OD OD IP20 CODEPL100P06 1.770

Ceiling lamp pleated fabric NO DIM

1 led module 57 W - 8750 Lm - 2700 K

OD OD IP20 CODEPL100P12 1.820

Ceiling lamp pleated fabric DIM TRIAC

1 led module 57 W - 8750 Lm - 2700 K

OD OD IP20 CODEPL100P13 1.900



Ceiling lamp pleated fabric DIM DALI-Push DIM

1 led module 57 W - 8750 Lm - 2700 K

OD OD IP20 CODEPL100P14 1.930

PRODUCTS: Cocò Demi
DESIGN: design: Brian Rasmussen 2024

Pendant lamp in hand-finished pleated fabric.
 Opal plex finishing underneath.

Symbol Index   → • / present - / absent OD / On Demand

COCÒ DEMI

Ceiling lamp D.150

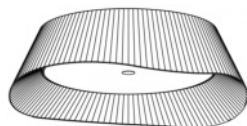

150 cm
59.05"

46 cm
18.11"

DESCRIZIONE

SORGENTE



IP

CODICE

Ceiling lamp pleated fabric NO DIM

1 led module 88 W - 12380 Lm - 2700 K

OD OD IP20 CODEPL150P02 3.690

Ceiling lamp pleated fabric DIM DALI-Push DIM

1 led module 88 W - 12380 Lm - 2700 K

OD OD IP20 CODEPL150P03 3.770

NOTE: on demand, LED modules are also available in 3000K and 4000K, without surcharge.

- 0

PRODUCTS: Discovolante

DESIGN: design: Paolo Grasselli 2004

Pendant, wall/ ceiling lamp available in cotton, washable, velvet, wool, Kvadrat, pleated and pleated ribbon fabrics.

On demand, lampshade available in For nature fabric (with surcharge).

One side frosted plex finishing underneath.



On demand, the pendant lamp can have a top protective disk in plex, usable only with LED bulbs or modules, with surcharge as per price list.

Symbol Index  → • / present - / absent OD / On Demand

DISCOVOLANTE

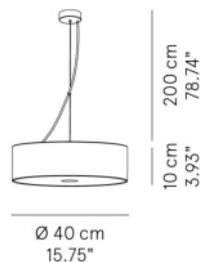
Pendant lamp - ø 40



DESCRIZIONE	SORGENTE			IP	CODICE	
2 lights cotton	2xE27max watt 42 W HES	OD	OD	IP20	DISESP040C02	515
2 lights washable	2xE27max watt 42 W HES	OD	OD	IP20	DISESP040T02	580
2 lights velvet	2xE27max watt 42 W HES	OD	OD	IP20	DISESP040O02	590
2 lights wool	2xE27max watt 42 W HES	OD	OD	IP20	DISESP040E02	590
2 light bulbs Kvadrat	2xE27max watt 42 W HES	OD	OD	IP20	DISESP040I02	605
2 lights pleated fabric	2xE27max watt 42 W HES	OD	OD	IP20	DISESP040P02	620
2 lights pleated ribbon fabric	2xE27max watt 42 W HES	OD	OD	IP20	DISESP040R02	630
1 light cotton NO DIM	1 led module 18 W - 3000 Lm - 2700 K	OD	OD	IP20	DISESP040C06	630
1 light washable NO DIM	1 led module 18 W - 3000 Lm - 2700 K	OD	OD	IP20	DISESP040T06	695
1 light velvet NO DIM	1 led module 18 W - 3000 Lm - 2700 K	OD	OD	IP20	DISESP040O06	705
1 light wool NO DIM	1 led module 18 W - 3000 Lm - 2700 K	OD	OD	IP20	DISESP040E06	705
1 light Kvadrat NO DIM	1 led module 18 W - 3000 Lm - 2700 K	OD	OD	IP20	DISESP040I06	720
1 light pleated fabric NO DIM	1 led module 18 W - 3000 Lm - 2700 K	OD	OD	IP20	DISESP040P06	735
1 light pleated ribbon fabric NO DIM	1 led module 18 W - 3000 Lm - 2700 K	OD	OD	IP20	DISESP040R06	745
1 light cotton DIM TRIAC	1 led module 18 W - 3000 Lm - 2700 K	OD	OD	IP20	DISESP040C07	640
1 light washable DIM TRIAC	1 led module 18 W - 3000 Lm - 2700 K	OD	OD	IP20	DISESP040T07	705
1 light velvet DIM TRIAC	1 led module 18 W - 3000 Lm - 2700 K	OD	OD	IP20	DISESP040O07	715
1 light wool DIM TRIAC	1 led module 18 W - 3000 Lm - 2700 K	OD	OD	IP20	DISESP040E07	715
1 light Kvadrat DIM TRIAC	1 led module 18 W - 3000 Lm - 2700 K	OD	OD	IP20	DISESP040I07	730
1 light pleated fabric DIM TRIAC	1 led module 18 W - 3000 Lm - 2700 K	OD	OD	IP20	DISESP040P07	745
1 light pleated ribbon fabric DIM TRIAC	1 led module 18 W - 3000 Lm - 2700 K	OD	OD	IP20	DISESP040R07	755

PRODUCTS: Discovolante

DESIGN: design: Paolo Grasselli 2004

Pendant, wall/ ceiling lamp available in cotton, washable, velvet, wool, Kvadrat, pleated and pleated ribbon fabrics.

On demand, lampshade available in For nature fabric (with surcharge).

One side frosted plex finishing underneath.



On demand, the pendant lamp can have a top protective disk in plex, usable only with LED bulbs or modules, with surcharge as per price list.

Symbol Index  → • / present - / absent OD / On Demand

DISCOVOLANTE

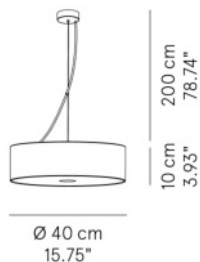
Pendant lamp - ø 40



DESCRIZIONE	SORGENTE			IP	CODICE	
1 light cotton DIM DALI-Push DIM	1 led module 18 W - 3000 Lm - 2700 K	OD	OD	IP20	DISESP040C08	730
1 light washable DIM DALI-Push DIM	1 led module 18 W - 3000 Lm - 2700 K	OD	OD	IP20	DISESP040T08	795
1 light velvet DIM DALI-Push DIM	1 led module 18 W - 3000 Lm - 2700 K	OD	OD	IP20	DISESP040O08	805
1 light wool DIM DALI-Push DIM	1 led module 18 W - 3000 Lm - 2700 K	OD	OD	IP20	DISESP040E08	805
1 light Kvadrat DIM DALI-Push DIM	1 led module 18 W - 3000 Lm - 2700 K	OD	OD	IP20	DISESP040I08	820
1 light pleated fabric DIM DALI-Push DIM	1 led module 18 W - 3000 Lm - 2700 K	OD	OD	IP20	DISESP040P08	835
1 light pleated ribbon fabric DIM DALI-Push DIM	1 led module 18 W - 3000 Lm - 2700 K	OD	OD	IP20	DISESP040R08	845

Accessory

Top protective disk in opal plex

OD IP20 DISEPX040F01 90

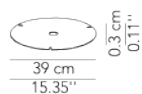

PRODUCTS: Discovolante



DESIGN: design: Paolo Grasselli 2004

Pendant, wall/ ceiling lamp available in cotton, washable, velvet, wool, Kvadrat, pleated and pleated ribbon fabrics.

On demand, lampshade available in For nature fabric (with surcharge).

One side frosted plex finishing underneath.



On demand, the pendant lamp can have a top protective disk in plex, usable only with LED bulbs or modules, with surcharge as per price list.

Symbol Index   → • / present - / absent OD / On Demand

DISCOVOLANTE

Pendant lamp - ø 60



DESCRIZIONE	SORGENTE			IP	CODICE	
3 lights cotton	3xE27max watt 42 W HES	OD	OD	IP20	DISESP060C02	705
3 lights washable	3xE27max watt 42 W HES	OD	OD	IP20	DISESP060T02	765
3 lights velvet	3xE27max watt 42 W HES	OD	OD	IP20	DISESP060O02	775
3 lights wool	3xE27max watt 42 W HES	OD	OD	IP20	DISESP060E02	775
3 lights Kvadrat	3xE27max watt 42 W HES	OD	OD	IP20	DISESP060I02	815
3 lights pleated fabric	3xE27max watt 42 W HES	OD	OD	IP20	DISESP060P02	900
3 lights pleated ribbon fabric	3xE27max watt 42 W HES	OD	OD	IP20	DISESP060R02	920
1 light cotton NO DIM	1 led module 23 W - 3628 Lm - 2700 K	OD	OD	IP20	DISESP060C06	915
1 light washable NO DIM	1 led module 23 W - 3628 Lm - 2700 K	OD	OD	IP20	DISESP060T06	975
1 light velvet NO DIM	1 led module 23 W - 3628 Lm - 2700 K	OD	OD	IP20	DISESP060O06	985
1 light wool NO DIM	1 led module 23 W - 3628 Lm - 2700 K	OD	OD	IP20	DISESP060E06	985
1 light Kvadrat NO DIM	1 led module 23 W - 3628 Lm - 2700 K	OD	OD	IP20	DISESP060I06	1.020
1 light pleated fabric NO DIM	1 led module 23 W - 3628 Lm - 2700 K	OD	OD	IP20	DISESP060P06	1.110
1 light pleated ribbon fabric NO DIM	1 led module 23 W - 3628 Lm - 2700 K	OD	OD	IP20	DISESP060R06	1.130
1 light cotton DIM TRIAC	1 led module 23 W - 3628 Lm - 2700 K	OD	OD	IP20	DISESP060C07	985
1 light washable DIM TRIAC	1 led module 23 W - 3628 Lm - 2700 K	OD	OD	IP20	DISESP060T07	1.050
1 light velvet DIM TRIAC	1 led module 23 W - 3628 Lm - 2700 K	OD	OD	IP20	DISESP060O07	1.060
1 light wool DIM TRIAC	1 led module 23 W - 3628 Lm - 2700 K	OD	OD	IP20	DISESP060E07	1.060
1 light Kvadrat DIM TRIAC	1 led module 23 W - 3628 Lm - 2700 K	OD	OD	IP20	DISESP060I07	1.090
1 light pleated fabric DIM TRIAC	1 led module 23 W - 3628 Lm - 2700 K	OD	OD	IP20	DISESP060P07	1.180
1 light pleated ribbon fabric DIM TRIAC	1 led module 23 W - 3628 Lm - 2700 K	OD	OD	IP20	DISESP060R07	1.200

PRODUCTS: Discovolante

DESIGN: design: Paolo Grasselli 2004

Pendant, wall/ ceiling lamp available in cotton, washable, velvet, wool, Kvadrat, pleated and pleated ribbon fabrics.

On demand, lampshade available in For nature fabric (with surcharge).

One side frosted plex finishing underneath.



On demand, the pendant lamp can have a top protective disk in plex, usable only with LED bulbs or modules, with surcharge as per price list.

Symbol Index  → • / present - / absent OD / On Demand

DISCOVOLANTE

Pendant lamp - ø 60



DESCRIZIONE	SORGENTE			IP	CODICE	
1 light cotton DIM DALI-Push DIM	1 led module 23 W - 3628 Lm - 2700 K	OD	OD	IP20	DISESP060C08	985
1 light washable DIM DALI-Push DIM	1 led module 23 W - 3628 Lm - 2700 K	OD	OD	IP20	DISESP060T08	1.050
1 light velvet DIM DALI-Push DIM	1 led module 23 W - 3628 Lm - 2700 K	OD	OD	IP20	DISESP060O08	1.060
1 light wool DIM DALI-Push DIM	1 led module 23 W - 3628 Lm - 2700 K	OD	OD	IP20	DISESP060E08	1.060
1 light Kvadrat DIM DALI-Push DIM	1 led module 23 W - 3628 Lm - 2700 K	OD	OD	IP20	DISESP060I08	1.090
1 light pleated fabric DIM DALI-Push DIM	1 led module 23 W - 3628 Lm - 2700 K	OD	OD	IP20	DISESP060P08	1.180
1 light pleated ribbon fabric DIM DALI-Push DIM	1 led module 23 W - 3628 Lm - 2700 K	OD	OD	IP20	DISESP060R08	1.200
1 light cotton NO DIM	1 led module 57 W - 8750 Lm - 2700 K	OD	OD	IP20	DISESP060C11	1.090
1 light washable NO DIM	1 led module 57 W - 8750 Lm - 2700 K	OD	OD	IP20	DISESP060T11	1.155
1 light velvet NO DIM	1 led module 57 W - 8750 Lm - 2700 K	OD	OD	IP20	DISESP060O11	1.165
1 light wool NO DIM	1 led module 57 W - 8750 Lm - 2700 K	OD	OD	IP20	DISESP060E11	1.165
1 light Kvadrat NO DIM	1 led module 57 W - 8750 Lm - 2700 K	OD	OD	IP20	DISESP060I11	1.195
1 light pleated fabric NO DIM	1 led module 57 W - 8750 Lm - 2700 K	OD	OD	IP20	DISESP060P11	1.285
1 light pleated ribbon fabric NO DIM	1 led module 57 W - 8750 Lm - 2700 K	OD	OD	IP20	DISESP060R11	1.305
1 light cotton DIM TRIAC	1 led module 57 W - 8750 Lm - 2700 K	OD	OD	IP20	DISESP060C13	1.155
1 light washable DIM TRIAC	1 led module 57 W - 8750 Lm - 2700 K	OD	OD	IP20	DISESP060T13	1.220
1 light velvet DIM TRIAC	1 led module 57 W - 8750 Lm - 2700 K	OD	OD	IP20	DISESP060O13	1.240
1 light wool DIM TRIAC	1 led module 57 W - 8750 Lm - 2700 K	OD	OD	IP20	DISESP060E13	1.240
1 light Kvadrat DIM TRIAC	1 led module 57 W - 8750 Lm - 2700 K	OD	OD	IP20	DISESP060I13	1.270
1 light pleated fabric DIM TRIAC	1 led module 57 W - 8750 Lm - 2700 K	OD	OD	IP20	DISESP060P13	1.350
1 light pleated ribbon fabric DIM TRIAC	1 led module 57 W - 8750 Lm - 2700 K	OD	OD	IP20	DISESP060R13	1.370

PRODUCTS: Discovolante

DESIGN: design: Paolo Grasselli 2004

Pendant, wall/ ceiling lamp available in cotton, washable, velvet, wool, Kvadrat, pleated and pleated ribbon fabrics.

On demand, lampshade available in For nature fabric (with surcharge).

One side frosted plex finishing underneath.



On demand, the pendant lamp can have a top protective disk in plex, usable only with LED bulbs or modules, with surcharge as per price list.

Symbol Index  → • / present - / absent OD / On Demand

DISCOVOLANTE

Pendant lamp - ø 60



DESCRIZIONE	SORGENTE			IP	CODICE	
1 light cotton DIM DALI-Push DIM	1 led module 57 W - 8750 Lm - 2700 K	OD	OD	IP20	DISESP060C12	1.210
1 light washable DIM DALI-Push DIM	1 led module 57 W - 8750 Lm - 2700 K	OD	OD	IP20	DISESP060T12	1.270
1 light velvet DIM DALI-Push DIM	1 led module 57 W - 8750 Lm - 2700 K	OD	OD	IP20	DISESP060O12	1.290
1 light wool DIM DALI-Push DIM	1 led module 57 W - 8750 Lm - 2700 K	OD	OD	IP20	DISESP060E12	1.290
1 light Kvadrat DIM DALI-Push DIM	1 led module 57 W - 8750 Lm - 2700 K	OD	OD	IP20	DISESP060I12	1.315
1 light pleated fabric DIM DALI-Push DIM	1 led module 57 W - 8750 Lm - 2700 K	OD	OD	IP20	DISESP060P12	1.400
1 light pleated ribbon fabric DIM DALI-Push DIM	1 led module 57 W - 8750 Lm - 2700 K	OD	OD	IP20	DISESP060R12	1.425

Accessory

Top protective disk in opal plex	OD	IP20	DISEPX060F01	140
----------------------------------	----	------	--------------	-----



PRODUCTS: Discovolante

DESIGN: design: Paolo Grasselli 2004

Pendant, wall/ ceiling lamp available in cotton, washable, velvet, wool, Kvadrat, pleated and pleated ribbon fabrics.

On demand, lampshade available in For nature fabric (with surcharge).

One side frosted plex finishing underneath.



On demand, the pendant lamp can have a top protective disk in plex, usable only with LED bulbs or modules, with surcharge as per price list.

Symbol Index  → • / present - / absent OD / On Demand

DISCOVOLANTE

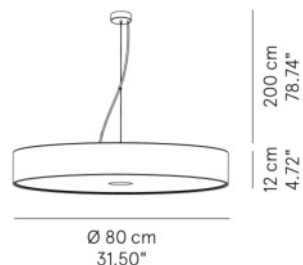
Pendant lamp - ø 80



DESCRIZIONE	SORGENTE			IP	CODICE	
4 lights cotton	4xE27max watt 42 W HES	OD	OD	IP20	DISESP080C02	975
4 lights washable	4xE27max watt 42 W HES	OD	OD	IP20	DISESP080T02	1.065
4 lights velvet	4xE27max watt 42 W HES	OD	OD	IP20	DISESP080O02	1.085
4 lights wool	4xE27max watt 42 W HES	OD	OD	IP20	DISESP080E02	1.085
4 lights Kvadrat	4xE27max watt 42 W HES	OD	OD	IP20	DISESP080I02	1.135
4 lights pleated fabric	4xE27max watt 42 W HES	OD	OD	IP20	DISESP080P02	1.185
4 lights pleated ribbon fabric	4xE27max watt 42 W HES	OD	OD	IP20	DISESP080R02	1.220
1 light cotton NO DIM	1 led module 57 W - 8750 Lm - 2700 K	OD	OD	IP20	DISESP080C16	1.335
1 light washable NO DIM	1 led module 57 W - 8750 Lm - 2700 K	OD	OD	IP20	DISESP080T16	1.425
1 light velvet NO DIM	1 led module 57 W - 8750 Lm - 2700 K	OD	OD	IP20	DISESP080O16	1.445
1 light wool NO DIM	1 led module 57 W - 8750 Lm - 2700 K	OD	OD	IP20	DISESP080E16	1.445
1 light Kvadrat NO DIM	1 led module 57 W - 8750 Lm - 2700 K	OD	OD	IP20	DISESP080I16	1.490
1 light pleated fabric NO DIM	1 led module 57 W - 8750 Lm - 2700 K	OD	OD	IP20	DISESP080P16	1.545
1 light pleated ribbon fabric NO DIM	1 led module 57 W - 8750 Lm - 2700 K	OD	OD	IP20	DISESP080R16	1.575
1 light cotton DIM TRIAC	1 led module 57 W - 8750 Lm - 2700 K	OD	OD	IP20	DISESP080C10	1.395
1 light washable DIM TRIAC	1 led module 57 W - 8750 Lm - 2700 K	OD	OD	IP20	DISESP080T10	1.485
1 light velvet DIM TRIAC	1 led module 57 W - 8750 Lm - 2700 K	OD	OD	IP20	DISESP080O10	1.505
1 light wool DIM TRIAC	1 led module 57 W - 8750 Lm - 2700 K	OD	OD	IP20	DISESP080E10	1.505
1 light Kvadrat DIM TRIAC	1 led module 57 W - 8750 Lm - 2700 K	OD	OD	IP20	DISESP080I10	1.555
1 light pleated fabric DIM TRIAC	1 led module 57 W - 8750 Lm - 2700 K	OD	OD	IP20	DISESP080P10	1.605
1 light pleated ribbon fabric DIM TRIAC	1 led module 57 W - 8750 Lm - 2700 K	OD	OD	IP20	DISESP080R10	1.640

PRODUCTS: Discovolante



DESIGN: design: Paolo Grasselli 2004

Pendant, wall/ ceiling lamp available in cotton, washable, velvet, wool, Kvadrat, pleated and pleated ribbon fabrics.

On demand, lampshade available in For nature fabric (with surcharge).

One side frosted plex finishing underneath.



On demand, the pendant lamp can have a top protective disk in plex, usable only with LED bulbs or modules, with surcharge as per price list.

Symbol Index   → • / present - / adsent OD / On Demand

DISCOVOLANTE

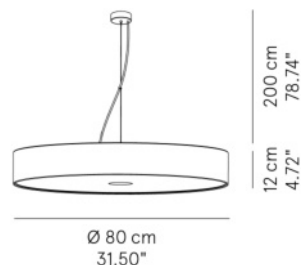
Pendant lamp - ø 80



DESCRIZIONE	SORGENTE			IP	CODICE	
1 light cotton DIM DALI-Push DIM	1 led module 57 W - 8750 Lm - 2700 K	OD	OD	IP20	DISESP080C17	1.450
1 light washable DIM DALI-Push DIM	1 led module 57 W - 8750 Lm - 2700 K	OD	OD	IP20	DISESP080T17	1.540
1 light velvet DIM DALI-Push DIM	1 led module 57 W - 8750 Lm - 2700 K	OD	OD	IP20	DISESP080O17	1.560
1 light wool DIM DALI-Push DIM	1 led module 57 W - 8750 Lm - 2700 K	OD	OD	IP20	DISESP080E17	1.560
1 light Kvadrat DIM DALI-Push DIM	1 led module 57 W - 8750 Lm - 2700 K	OD	OD	IP20	DISESP080I17	1.605
1 light pleated fabric DIM DALI-Push DIM	1 led module 57 W - 8750 Lm - 2700 K	OD	OD	IP20	DISESP080P17	1.660
1 light pleated ribbon fabric DIM DALI-Push DIM	1 led module 57 W - 8750 Lm - 2700 K	OD	OD	IP20	DISESP080R17	1.690
1 light cotton NO DIM	1 led module 88 W - 12380 Lm - 2700 K	OD	OD	IP20	DISESP080C13	1.490
1 light washable NO DIM	1 led module 88 W - 12380 Lm - 2700 K	OD	OD	IP20	DISESP080T13	1.580
1 light velvet NO DIM	1 led module 88 W - 12380 Lm - 2700 K	OD	OD	IP20	DISESP080O13	1.600
1 light wool NO DIM	1 led module 88 W - 12380 Lm - 2700 K	OD	OD	IP20	DISESP080E13	1.600
1 light Kvadrat NO DIM	1 led module 88 W - 12380 Lm - 2700 K	OD	OD	IP20	DISESP080I13	1.650
1 light pleated fabric NO DIM	1 led module 88 W - 12380 Lm - 2700 K	OD	OD	IP20	DISESP080P13	1.700
1 light pleated ribbon fabric NO DIM	1 led module 88 W - 12380 Lm - 2700 K	OD	OD	IP20	DISESP080R13	1.735
1 light cotton DIM DALI-Push DIM	1 led module 88 W - 12380 Lm - 2700 K	OD	OD	IP20	DISESP080C15	1.630
1 light washable DIM DALI-Push DIM	1 led module 88 W - 12380 Lm - 2700 K	OD	OD	IP20	DISESP080T15	1.735
1 light velvet DIM DALI-Push DIM	1 led module 88 W - 12380 Lm - 2700 K	OD	OD	IP20	DISESP080O15	1.755
1 light wool DIM DALI-Push DIM	1 led module 88 W - 12380 Lm - 2700 K	OD	OD	IP20	DISESP080E15	1.755
1 light Kvadrat DIM DALI-Push DIM	1 led module 88 W - 12380 Lm - 2700 K	OD	OD	IP20	DISESP080I15	1.890
1 light pleated fabric DIM DALI-Push DIM	1 led module 88 W - 12380 Lm - 2700 K	OD	OD	IP20	DISESP080P15	1.945
1 light pleated ribbon fabric DIM DALI-Push DIM	1 led module 88 W - 12380 Lm - 2700 K	OD	OD	IP20	DISESP080R15	1.975

PRODUCTS: Discovolante



DESIGN: design: Paolo Grasselli 2004

Pendant, wall/ ceiling lamp available in cotton, washable, velvet, wool, Kvadrat, pleated and pleated ribbon fabrics.

On demand, lampshade available in For nature fabric (with surcharge).

One side frosted plex finishing underneath.

On demand, the pendant lamp can have a top protective disk in plex, usable only with LED bulbs or modules, with surcharge as per price list.

Symbol Index   → • / present - / absent OD / On Demand

DISCOVOLANTE

DESCRIZIONE

SORGENTE



IP

CODICE

Accessory

Top protective disk in opal plex

OD

IP20

DISEPX080F01

275

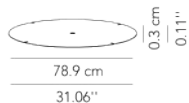

PRODUCTS: Discovolante

DESIGN: design: Paolo Grasselli 2004

Pendant, wall/ ceiling lamp available in cotton, washable, velvet, wool, Kvadrat, pleated and pleated ribbon fabrics.

On demand, lampshade available in For nature fabric (with surcharge).

One side frosted plex finishing underneath.



On demand, the pendant lamp can have a top protective disk in plex, usable only with LED bulbs or modules, with surcharge as per price list.

Symbol Index  → • / present - / absent OD / On Demand

DISCOVOLANTE

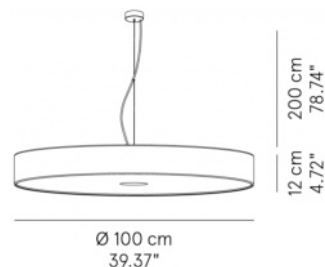
Pendant lamp - ø 100



DESCRIZIONE	SORGENTE			IP	CODICE	
4 lights cotton	4xE27max watt 42 W HES	OD	OD	IP20	DISESP100C02	1.220
4 lights washable	4xE27max watt 42 W HES	OD	OD	IP20	DISESP100T02	1.345
4 lights velvet	4xE27max watt 42 W HES	OD	OD	IP20	DISESP100O02	1.365
4 lights wool	4xE27max watt 42 W HES	OD	OD	IP20	DISESP100E02	1.365
4 lights Kvadrat	4xE27max watt 42 W HES	OD	OD	IP20	DISESP100I02	1.425
4 lights pleated fabric	4xE27max watt 42 W HES	OD	OD	IP20	DISESP100P02	1.500
4 lights pleated ribbon fabric	4xE27max watt 42 W HES	OD	OD	IP20	DISESP100R02	1.545
1 light cotton NO DIM	1 led module 57 W - 8750 Lm - 2700 K	OD	OD	IP20	DISESP100C17	1.575
1 light washable NO DIM	1 led module 57 W - 8750 Lm - 2700 K	OD	OD	IP20	DISESP100T17	1.700
1 light velvet NO DIM	1 led module 57 W - 8750 Lm - 2700 K	OD	OD	IP20	DISESP100O17	1.720
1 light wool NO DIM	1 led module 57 W - 8750 Lm - 2700 K	OD	OD	IP20	DISESP100E17	1.720
1 light Kvadrat NO DIM	1 led module 57 W - 8750 Lm - 2700 K	OD	OD	IP20	DISESP100H17	1.780
1 light pleated fabric NO DIM	1 led module 57 W - 8750 Lm - 2700 K	OD	OD	IP20	DISESP100P17	1.860
1 light pleated ribbon fabric NO DIM	1 led module 57 W - 8750 Lm - 2700 K	OD	OD	IP20	DISESP100R17	1.900
1 light cotton DIM TRIAC	1 led module 57 W - 8750 Lm - 2700 K	OD	OD	IP20	DISESP100C19	1.640
1 light washable DIM TRIAC	1 led module 57 W - 8750 Lm - 2700 K	OD	OD	IP20	DISESP100T19	1.765
1 light velvet DIM TRIAC	1 led module 57 W - 8750 Lm - 2700 K	OD	OD	IP20	DISESP100O19	1.785
1 light wool DIM TRIAC	1 led module 57 W - 8750 Lm - 2700 K	OD	OD	IP20	DISESP100E19	1.785
1 light Kvadrat DIM TRIAC	1 led module 57 W - 8750 Lm - 2700 K	OD	OD	IP20	DISESP100H19	1.845
1 light pleated fabric DIM TRIAC	1 led module 57 W - 8750 Lm - 2700 K	OD	OD	IP20	DISESP100P19	1.920
1 light pleated ribbon fabric DIM TRIAC	1 led module 57 W - 8750 Lm - 2700 K	OD	OD	IP20	DISESP100R19	1.965

PRODUCTS: Discovolante

DESIGN: design: Paolo Grasselli 2004

Pendant, wall/ ceiling lamp available in cotton, washable, velvet, wool, Kvadrat, pleated and pleated ribbon fabrics.

On demand, lampshade available in For nature fabric (with surcharge).

One side frosted plex finishing underneath.

On demand, the pendant lamp can have a top protective disk in plex, usable only with LED bulbs or modules, with surcharge as per price list.

Symbol Index  → • / present - / adsent OD / On Demand

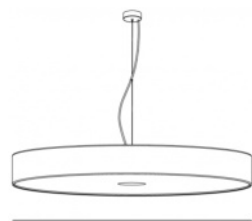

DISCOVOLANTE

Pendant lamp - ø 100



12 cm
4.72"
200 cm
78.74"

Ø 100 cm
39.37"

DESCRIZIONE	SORGENTE			IP	CODICE	
1 light cotton DIM DALI-Push DIM	1 led module 57 W - 8750 Lm - 2700 K	OD	OD	IP20	DISESP100C18	1.700
1 light washable DIM DALI-Push DIM	1 led module 57 W - 8750 Lm - 2700 K	OD	OD	IP20	DISESP100T18	1.815
1 light velvet DIM DALI-Push DIM	1 led module 57 W - 8750 Lm - 2700 K	OD	OD	IP20	DISESP100O18	1.840
1 light wool DIM DALI-Push DIM	1 led module 57 W - 8750 Lm - 2700 K	OD	OD	IP20	DISESP100E18	1.840
1 light Kvadrat DIM DALI-Push DIM	1 led module 57 W - 8750 Lm - 2700 K	OD	OD	IP20	DISESP100I18	1.895
1 light pleated fabric DIM DALI-Push DIM	1 led module 57 W - 8750 Lm - 2700 K	OD	OD	IP20	DISESP100P18	1.985
1 light pleated ribbon fabric DIM DALI-Push DIM	1 led module 57 W - 8750 Lm - 2700 K	OD	OD	IP20	DISESP100R18	2.025
1 light cotton NO DIM	1 led module 88 W - 12380 Lm - 2700 K	OD	OD	IP20	DISESP100C13	1.735
1 light washable NO DIM	1 led module 88 W - 12380 Lm - 2700 K	OD	OD	IP20	DISESP100T13	1.860
1 light velvet NO DIM	1 led module 88 W - 12380 Lm - 2700 K	OD	OD	IP20	DISESP100O13	1.880
1 light wool NO DIM	1 led module 88 W - 12380 Lm - 2700 K	OD	OD	IP20	DISESP100E13	1.880
1 light Kvadrat NO DIM	1 led module 88 W - 12380 Lm - 2700 K	OD	OD	IP20	DISESP100I13	1.935
1 light pleated fabric NO DIM	1 led module 88 W - 12380 Lm - 2700 K	OD	OD	IP20	DISESP100P13	2.015
1 light pleated ribbon fabric NO DIM	1 led module 88 W - 12380 Lm - 2700 K	OD	OD	IP20	DISESP100R13	2.060
1 light cotton DIM DALI-Push DIM	1 led module 88 W - 12380 Lm - 2700 K	OD	OD	IP20	DISESP100C15	1.840
1 light washable DIM DALI-Push DIM	1 led module 88 W - 12380 Lm - 2700 K	OD	OD	IP20	DISESP100T15	1.965
1 light velvet DIM DALI-Push DIM	1 led module 88 W - 12380 Lm - 2700 K	OD	OD	IP20	DISESP100O15	1.985
1 light wool DIM DALI-Push DIM	1 led module 88 W - 12380 Lm - 2700 K	OD	OD	IP20	DISESP100E15	1.985
1 light Kvadrat DIM DALI-Push DIM	1 led module 88 W - 12380 Lm - 2700 K	OD	OD	IP20	DISESP100I15	2.040
1 light pleated fabric DIM DALI-Push DIM	1 led module 88 W - 12380 Lm - 2700 K	OD	OD	IP20	DISESP100P15	2.120
1 light pleated ribbon fabric DIM DALI-Push DIM	1 led module 88 W - 12380 Lm - 2700 K	OD	OD	IP20	DISESP100R15	2.165

PRODUCTS: Discovolante
DESIGN: design: Paolo Grasselli 2004

Pendant, wall/ ceiling lamp available in cotton, washable, velvet, wool, Kvadrat, pleated and pleated ribbon fabrics.
 On demand, lampshade available in For nature fabric (with surcharge).
 One side frosted plex finishing underneath.
 On demand, the pendant lamp can have a top protective disk in plex, usable only with LED bulbs or modules, with surcharge as per price list.

Symbol Index  → • / present - / absent OD / On Demand

DISCOVOLANTE

DESCRIZIONE

SORGENTE



IP

CODICE

Accessory

Top protective disk in opal plex

OD IP20 DISEPX100F01 360

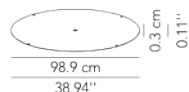

NOTE: on demand, LED modules are also available in 3000K and 4000K, without surcharge.

- 0

Ceiling lamp - ø 20

1 light cotton NO DIM

1 led module 9 W - 830 Lm - 3000 K - >85

OD OD IP20 DISEPL020C06 240

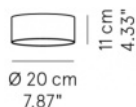

1 light washable NO DIM

1 led module 9 W - 830 Lm - 3000 K - >85

OD OD IP20 DISEPL020T06 275

1 light velvet NO DIM

1 led module 9 W - 830 Lm - 3000 K - >85

OD OD IP20 DISEPL020O06 275

1 light wool NO DIM

1 led module 9 W - 830 Lm - 3000 K - >85

OD OD IP20 DISEPL020E06 275

1 light Kvadrat NO DIM

1 led module 9 W - 830 Lm - 3000 K - >85

OD OD IP20 DISEPL020I06 285

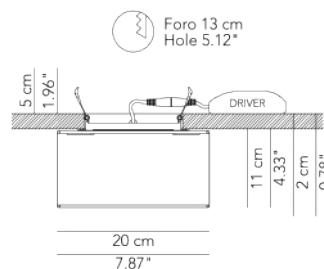

1 light cotton DIM TRIAC

1 led module 9 W - 830 Lm - 3000 K - >85

OD OD IP20 DISEPL020C07 280

1 light washable DIM TRIAC

1 led module 9 W - 830 Lm - 3000 K - >85

OD OD IP20 DISEPL020T07 310

1 light velvet DIM TRIAC

1 led module 9 W - 830 Lm - 3000 K - >85

OD OD IP20 DISEPL020O07 310

1 light wool DIM TRIAC

1 led module 9 W - 830 Lm - 3000 K - >85

OD OD IP20 DISEPL020E07 310

1 light Kvadrat DIM TRIAC

1 led module 9 W - 830 Lm - 3000 K - >85

OD OD IP20 DISEPL020I07 320

1 light cotton DIM DALI-Push DIM

1 led module 9 W - 830 Lm - 3000 K - >85

OD OD IP20 DISEPL020C08 360

1 light washable DIM DALI-Push DIM

1 led module 9 W - 830 Lm - 3000 K - >85

OD OD IP20 DISEPL020T08 395

1 light velvet DIM DALI-Push DIM

1 led module 9 W - 830 Lm - 3000 K - >85

OD OD IP20 DISEPL020O08 395

1 light wool DIM DALI-Push DIM

1 led module 9 W - 830 Lm - 3000 K - >85

OD OD IP20 DISEPL020E08 395

1 light Kvadrat DIM DALI-Push DIM

1 led module 9 W - 830 Lm - 3000 K - >85

OD OD IP20 DISEPL020I08 405

PRODUCTS: Discovolante



DESIGN: design: Paolo Grasselli 2004

Pendant, wall/ ceiling lamp available in cotton, washable, velvet, wool, Kvadrat, pleated and pleated ribbon fabrics.

On demand, lampshade available in For nature fabric (with surcharge).

One side frosted plex finishing underneath.

On demand, the pendant lamp can have a top protective disk in plex, usable only with LED bulbs or modules, with surcharge as per price list.

Symbol Index   → • / present - / absent OD / On Demand

DISCOVOLANTE

Wall/Ceiling lamp - ø 40



Ø 40 cm
15.75"



11 cm
4.33"

DESCRIZIONE	SORGENTE			IP	CODICE	
2 lights cotton	2xE27max watt 28 W HES	OD	OD	IP20	DISEAP040C02	485
2 lights washable	2xE27max watt 28 W HES	OD	OD	IP20	DISEAP040T02	545
2 lights velvet	2xE27max watt 28 W HES	OD	OD	IP20	DISEAP040O02	555
2 lights wool	2xE27max watt 28 W HES	OD	OD	IP20	DISEAP040E02	555
2 light bulbs Kvadrat	2xE27max watt 28 W HES	OD	OD	IP20	DISEAP040I02	570
2 lights pleated fabric	2xE27max watt 28 W HES	OD	OD	IP20	DISEAP040P02	590
2 lights pleated ribbon fabric	2xE27max watt 28 W HES	OD	OD	IP20	DISEAP040R02	600
1 light cotton NO DIM	1 led module 18 W - 3000 Lm - 2700 K	OD	OD	IP20	DISEAP040C06	590
1 light washable NO DIM	1 led module 18 W - 3000 Lm - 2700 K	OD	OD	IP20	DISEAP040T06	650
1 light velvet NO DIM	1 led module 18 W - 3000 Lm - 2700 K	OD	OD	IP20	DISEAP040O06	660
1 light wool NO DIM	1 led module 18 W - 3000 Lm - 2700 K	OD	OD	IP20	DISEAP040E06	660
1 light Kvadrat NO DIM	1 led module 18 W - 3000 Lm - 2700 K	OD	OD	IP20	DISEAP040I06	675
1 light pleated fabric NO DIM	1 led module 18 W - 3000 Lm - 2700 K	OD	OD	IP20	DISEAP040P06	695
1 light pleated ribbon fabric NO DIM	1 led module 18 W - 3000 Lm - 2700 K	OD	OD	IP20	DISEAP040R06	705
1 light cotton DIM TRIAC	1 led module 18 W - 3000 Lm - 2700 K	OD	OD	IP20	DISEAP040C07	610
1 light washable DIM TRIAC	1 led module 18 W - 3000 Lm - 2700 K	OD	OD	IP20	DISEAP040T07	670
1 light velvet DIM TRIAC	1 led module 18 W - 3000 Lm - 2700 K	OD	OD	IP20	DISEAP040O07	685
1 light wool DIM TRIAC	1 led module 18 W - 3000 Lm - 2700 K	OD	OD	IP20	DISEAP040E07	685
1 light Kvadrat DIM TRIAC	1 led module 18 W - 3000 Lm - 2700 K	OD	OD	IP20	DISEAP040I07	700
1 light pleated fabric DIM TRIAC	1 led module 18 W - 3000 Lm - 2700 K	OD	OD	IP20	DISEAP040P07	715
1 light pleated ribbon fabric DIM TRIAC	1 led module 18 W - 3000 Lm - 2700 K	OD	OD	IP20	DISEAP040R07	725

PRODUCTS: Discovolante

DESIGN: design: Paolo Grasselli 2004

Pendant, wall/ ceiling lamp available in cotton, washable, velvet, wool, Kvadrat, pleated and pleated ribbon fabrics.

On demand, lampshade available in For nature fabric (with surcharge).

One side frosted plex finishing underneath.

On demand, the pendant lamp can have a top protective disk in plex, usable only with LED bulbs or modules, with surcharge as per price list.

Symbol Index  → • / present - / adsent OD / On Demand

DISCOVOLANTE

Wall/Ceiling lamp - ø 40





11 cm
4.33"

Ø 40 cm
15.75"



Ø 40 cm
15.75"

11 cm
4.33"

DESCRIZIONE	SORGENTE			IP	CODICE	
1 light cotton DIM DALI-Push DIM	1 led module 18 W - 3000 Lm - 2700 K	OD	OD	IP20	DISEAP040C08	685
1 light washable DIM DALI-Push DIM	1 led module 18 W - 3000 Lm - 2700 K	OD	OD	IP20	DISEAP040T08	745
1 light velvet DIM DALI-Push DIM	1 led module 18 W - 3000 Lm - 2700 K	OD	OD	IP20	DISEAP040O08	755
1 light wool DIM DALI-Push DIM	1 led module 18 W - 3000 Lm - 2700 K	OD	OD	IP20	DISEAP040E08	755
1 light Kvadrat DIM DALI-Push DIM	1 led module 18 W - 3000 Lm - 2700 K	OD	OD	IP20	DISEAP040I08	770
1 light pleated fabric DIM DALI-Push DIM	1 led module 18 W - 3000 Lm - 2700 K	OD	OD	IP20	DISEAP040P08	790
1 light pleated ribbon fabric DIM DALI-Push DIM	1 led module 18 W - 3000 Lm - 2700 K	OD	OD	IP20	DISEAP040R08	800

PRODUCTS: Discovolante



DESIGN: design: Paolo Grasselli 2004

Pendant, wall/ ceiling lamp available in cotton, washable, velvet, wool, Kvadrat, pleated and pleated ribbon fabrics.

On demand, lampshade available in For nature fabric (with surcharge).

One side frosted plex finishing underneath.

On demand, the pendant lamp can have a top protective disk in plex, usable only with LED bulbs or modules, with surcharge as per price list.

Symbol Index   → • / present - / absent OD / On Demand

DISCOVOLANTE

Wall/Ceiling lamp - ø 60



Ø 60 cm
23.62"

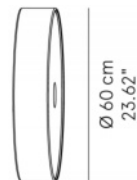

13 cm
5.12"

DESCRIZIONE	SORGENTE			IP	CODICE	
3 lights cotton	3xE27max watt 42 W HES	OD	OD	IP20	DISEAP060C02	715
3 lights washable	3xE27max watt 42 W HES	OD	OD	IP20	DISEAP060T02	775
3 lights velvet	3xE27max watt 42 W HES	OD	OD	IP20	DISEAP060O02	790
3 lights wool	3xE27max watt 42 W HES	OD	OD	IP20	DISEAP060E02	790
3 lights Kvadrat	3xE27max watt 42 W HES	OD	OD	IP20	DISEAP060I02	805
3 lights pleated fabric	3xE27max watt 42 W HES	OD	OD	IP20	DISEAP060P02	910
3 lights pleated ribbon fabric	3xE27max watt 42 W HES	OD	OD	IP20	DISEAP060R02	930
1 light cotton NO DIM	1 led module 23 W - 3628 Lm - 2700 K	OD	OD	IP20	DISEAP060C06	880
1 light washable NO DIM	1 led module 23 W - 3628 Lm - 2700 K	OD	OD	IP20	DISEAP060T06	945
1 light velvet NO DIM	1 led module 23 W - 3628 Lm - 2700 K	OD	OD	IP20	DISEAP060O06	955
1 light wool NO DIM	1 led module 23 W - 3628 Lm - 2700 K	OD	OD	IP20	DISEAP060E06	955
1 light Kvadrat NO DIM	1 led module 23 W - 3628 Lm - 2700 K	OD	OD	IP20	DISEAP060I06	985
1 light pleated fabric NO DIM	1 led module 23 W - 3628 Lm - 2700 K	OD	OD	IP20	DISEAP060P06	1.075
1 light pleated ribbon fabric NO DIM	1 led module 23 W - 3628 Lm - 2700 K	OD	OD	IP20	DISEAP060R06	1.095
1 light cotton DIM TRIAC	1 led module 23 W - 3628 Lm - 2700 K	OD	OD	IP20	DISEAP060C07	955
1 light washable DIM TRIAC	1 led module 23 W - 3628 Lm - 2700 K	OD	OD	IP20	DISEAP060T07	1.020
1 light velvet DIM TRIAC	1 led module 23 W - 3628 Lm - 2700 K	OD	OD	IP20	DISEAP060O07	1.030
1 light wool DIM TRIAC	1 led module 23 W - 3628 Lm - 2700 K	OD	OD	IP20	DISEAP060E07	1.030
1 light Kvadrat DIM TRIAC	1 led module 23 W - 3628 Lm - 2700 K	OD	OD	IP20	DISEAP060I07	1.060
1 light pleated fabric DIM TRIAC	1 led module 23 W - 3628 Lm - 2700 K	OD	OD	IP20	DISEAP060P07	1.150
1 light pleated ribbon fabric DIM TRIAC	1 led module 23 W - 3628 Lm - 2700 K	OD	OD	IP20	DISEAP060R07	1.170

PRODUCTS: Discovolante
DESIGN: design: Paolo Grasselli 2004

Pendant, wall/ ceiling lamp available in cotton, washable, velvet, wool, Kvadrat, pleated and pleated ribbon fabrics.
 On demand, lampshade available in For nature fabric (with surcharge).
 One side frosted plex finishing underneath.
 On demand, the pendant lamp can have a top protective disk in plex, usable only with LED bulbs or modules, with surcharge as per price list.

Symbol Index  → • / present - / absent OD / On Demand

DISCOVOLANTE



Wall/Ceiling lamp - ø 60

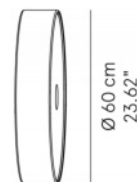

Ø 60 cm
23.62"



13 cm
5.12"

DESCRIZIONE	SORGENTE			IP	CODICE	
1 light cotton DIM DALI-Push DIM	1 led module 23 W - 3628 Lm - 2700 K	OD	OD	IP20	DISEAP060C08	955
1 light washable DIM DALI-Push DIM	1 led module 23 W - 3628 Lm - 2700 K	OD	OD	IP20	DISEAP060T08	1.020
1 light velvet DIM DALI-Push DIM	1 led module 23 W - 3628 Lm - 2700 K	OD	OD	IP20	DISEAP060O08	1.030
1 light wool DIM DALI-Push DIM	1 led module 23 W - 3628 Lm - 2700 K	OD	OD	IP20	DISEAP060E08	1.030
1 light Kvadrat DIM DALI-Push DIM	1 led module 23 W - 3628 Lm - 2700 K	OD	OD	IP20	DISEAP060I08	1.060
1 light pleated fabric DIM DALI-Push DIM	1 led module 23 W - 3628 Lm - 2700 K	OD	OD	IP20	DISEAP060P08	1.150
1 light pleated ribbon fabric DIM DALI-Push DIM	1 led module 23 W - 3628 Lm - 2700 K	OD	OD	IP20	DISEAP060R08	1.170
1 light cotton NO DIM	1 led module 57 W - 8750 Lm - 2700 K	OD	OD	IP20	DISEAP060C11	1.060
1 light washable NO DIM	1 led module 57 W - 8750 Lm - 2700 K	OD	OD	IP20	DISEAP060T11	1.125
1 light velvet NO DIM	1 led module 57 W - 8750 Lm - 2700 K	OD	OD	IP20	DISEAP060O11	1.135
1 light wool NO DIM	1 led module 57 W - 8750 Lm - 2700 K	OD	OD	IP20	DISEAP060E11	1.135
1 light Kvadrat NO DIM	1 led module 57 W - 8750 Lm - 2700 K	OD	OD	IP20	DISEAP060I11	1.165
1 light pleated fabric NO DIM	1 led module 57 W - 8750 Lm - 2700 K	OD	OD	IP20	DISEAP060P11	1.255
1 light pleated ribbon fabric NO DIM	1 led module 57 W - 8750 Lm - 2700 K	OD	OD	IP20	DISEAP060R11	1.275
1 light cotton DIM TRIAC	1 led module 57 W - 8750 Lm - 2700 K	OD	OD	IP20	DISEAP060C09	1.135
1 light washable DIM TRIAC	1 led module 57 W - 8750 Lm - 2700 K	OD	OD	IP20	DISEAP060T09	1.195
1 light velvet DIM TRIAC	1 led module 57 W - 8750 Lm - 2700 K	OD	OD	IP20	DISEAP060O09	1.210
1 light wool DIM TRIAC	1 led module 57 W - 8750 Lm - 2700 K	OD	OD	IP20	DISEAP060E09	1.210
1 light Kvadrat DIM TRIAC	1 led module 57 W - 8750 Lm - 2700 K	OD	OD	IP20	DISEAP060I09	1.270
1 light pleated fabric DIM TRIAC	1 led module 57 W - 8750 Lm - 2700 K	OD	OD	IP20	DISEAP060P09	1.330
1 light pleated ribbon fabric DIM TRIAC	1 led module 57 W - 8750 Lm - 2700 K	OD	OD	IP20	DISEAP060R09	1.350

PRODUCTS: Discovolante



DESIGN: design: Paolo Grasselli 2004

Pendant, wall/ ceiling lamp available in cotton, washable, velvet, wool, Kvadrat, pleated and pleated ribbon fabrics.

On demand, lampshade available in For nature fabric (with surcharge).

One side frosted plex finishing underneath.

On demand, the pendant lamp can have a top protective disk in plex, usable only with LED bulbs or modules, with surcharge as per price list.

Symbol Index   → • / present - / absent OD / On Demand

DISCOVOLANTE

Wall/Ceiling lamp - ø 60





Ø 60 cm
23.62"



Ø 60 cm
23.62"

13 cm
5.12"

DESCRIZIONE	SORGENTE			IP	CODICE	
1 light cotton DIM DALI-Push DIM	1 led module 57 W - 8750 Lm - 2700 K	OD	OD	IP20	DISEAP060C12	1.185
1 light washable DIM DALI-Push DIM	1 led module 57 W - 8750 Lm - 2700 K	OD	OD	IP20	DISEAP060T12	1.250
1 light velvet DIM DALI-Push DIM	1 led module 57 W - 8750 Lm - 2700 K	OD	OD	IP20	DISEAP060O12	1.260
1 light wool DIM DALI-Push DIM	1 led module 57 W - 8750 Lm - 2700 K	OD	OD	IP20	DISEAP060E12	1.260
1 light Kvadrat DIM DALI-Push DIM	1 led module 57 W - 8750 Lm - 2700 K	OD	OD	IP20	DISEAP060I12	1.325
1 light pleated fabric DIM DALI-Push DIM	1 led module 57 W - 8750 Lm - 2700 K	OD	OD	IP20	DISEAP060P12	1.380
1 light pleated ribbon fabric DIM DALI-Push DIM	1 led module 57 W - 8750 Lm - 2700 K	OD	OD	IP20	DISEAP060R12	1.400

PRODUCTS: Discovolante

DESIGN: design: Paolo Grasselli 2004

Pendant, wall/ ceiling lamp available in cotton, washable, velvet, wool, Kvadrat, pleated and pleated ribbon fabrics.

On demand, lampshade available in For nature fabric (with surcharge).

One side frosted plex finishing underneath.



On demand, the pendant lamp can have a top protective disk in plex, usable only with LED bulbs or modules, with surcharge as per price list.

Symbol Index  → • / present - / absent OD / On Demand

DISCOVOLANTE

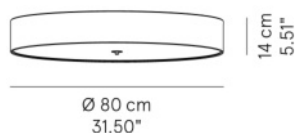
Ceiling lamp - ø 80



DESCRIZIONE	SORGENTE			IP	CODICE	
4 lights cotton	4xE27max watt 42 W HES	OD	OD	IP20	DISEPL080C02	1.000
4 lights washable	4xE27max watt 42 W HES	OD	OD	IP20	DISEPL080T02	1.085
4 lights velvet	4xE27max watt 42 W HES	OD	OD	IP20	DISEPL080O02	1.110
4 lights wool	4xE27max watt 42 W HES	OD	OD	IP20	DISEPL080E02	1.110
4 lights Kvadrat	4xE27max watt 42 W HES	OD	OD	IP20	DISEPL080I02	1.155
4 lights pleated fabric	4xE27max watt 42 W HES	OD	OD	IP20	DISEPL080P02	1.210
4 lights pleated ribbon fabric	4xE27max watt 42 W HES	OD	OD	IP20	DISEPL080R02	1.240
1 light cotton NO DIM	1 led module 57 W - 8750 Lm - 2700 K	OD	OD	IP20	DISEPL080C16	1.260
1 light washable NO DIM	1 led module 57 W - 8750 Lm - 2700 K	OD	OD	IP20	DISEPL080T16	1.350
1 light velvet NO DIM	1 led module 57 W - 8750 Lm - 2700 K	OD	OD	IP20	DISEPL080O16	1.370
1 light wool NO DIM	1 led module 57 W - 8750 Lm - 2700 K	OD	OD	IP20	DISEPL080E16	1.370
1 light Kvadrat NO DIM	1 led module 57 W - 8750 Lm - 2700 K	OD	OD	IP20	DISEPL080H16	1.420
1 light pleated fabric NO DIM	1 led module 57 W - 8750 Lm - 2700 K	OD	OD	IP20	DISEPL080P16	1.470
1 light pleated ribbon fabric NO DIM	1 led module 57 W - 8750 Lm - 2700 K	OD	OD	IP20	DISEPL080R16	1.500
1 light cotton DIM TRIAC	1 led module 57 W - 8750 Lm - 2700 K	OD	OD	IP20	DISEPL080C10	1.335
1 light washable DIM TRIAC	1 led module 57 W - 8750 Lm - 2700 K	OD	OD	IP20	DISEPL080T10	1.425
1 light velvet DIM TRIAC	1 led module 57 W - 8750 Lm - 2700 K	OD	OD	IP20	DISEPL080O10	1.445
1 light wool DIM TRIAC	1 led module 57 W - 8750 Lm - 2700 K	OD	OD	IP20	DISEPL080E10	1.445
1 light Kvadrat DIM TRIAC	1 led module 57 W - 8750 Lm - 2700 K	OD	OD	IP20	DISEPL080H10	1.490
1 light pleated fabric DIM TRIAC	1 led module 57 W - 8750 Lm - 2700 K	OD	OD	IP20	DISEPL080P10	1.545
1 light pleated ribbon fabric DIM TRIAC	1 led module 57 W - 8750 Lm - 2700 K	OD	OD	IP20	DISEPL080R10	1.575

PRODUCTS: Discovolante

DESIGN: design: Paolo Grasselli 2004

Pendant, wall/ ceiling lamp available in cotton, washable, velvet, wool, Kvadrat, pleated and pleated ribbon fabrics.

On demand, lampshade available in For nature fabric (with surcharge).

One side frosted plex finishing underneath.

On demand, the pendant lamp can have a top protective disk in plex, usable only with LED bulbs or modules, with surcharge as per price list.

Symbol Index  → • / present - / adsent OD / On Demand

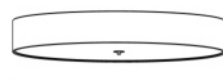

DISCOVOLANTE

Ceiling lamp - ø 80



14 cm
5.51"

Ø 80 cm
31.50"

DESCRIZIONE	SORGENTE			IP	CODICE	
1 light cotton DIM DALI-Push DIM	1 led module 57 W - 8750 Lm - 2700 K	OD	OD	IP20	DISEPL080C17	1.385
1 light washable DIM DALI-Push DIM	1 led module 57 W - 8750 Lm - 2700 K	OD	OD	IP20	DISEPL080T17	1.475
1 light velvet DIM DALI-Push DIM	1 led module 57 W - 8750 Lm - 2700 K	OD	OD	IP20	DISEPL080O17	1.495
1 light wool DIM DALI-Push DIM	1 led module 57 W - 8750 Lm - 2700 K	OD	OD	IP20	DISEPL080E17	1.495
1 light Kvadrat DIM DALI-Push DIM	1 led module 57 W - 8750 Lm - 2700 K	OD	OD	IP20	DISEPL080I17	1.545
1 light pleated fabric DIM DALI-Push DIM	1 led module 57 W - 8750 Lm - 2700 K	OD	OD	IP20	DISEPL080P17	1.595
1 light pleated ribbon fabric DIM DALI-Push DIM	1 led module 57 W - 8750 Lm - 2700 K	OD	OD	IP20	DISEPL080R17	1.630
1 light cotton NO DIM	1 led module 88 W - 12380 Lm - 2700 K	OD	OD	IP20	DISEPL080C13	1.605
1 light washable NO DIM	1 led module 88 W - 12380 Lm - 2700 K	OD	OD	IP20	DISEPL080T13	1.695
1 light velvet NO DIM	1 led module 88 W - 12380 Lm - 2700 K	OD	OD	IP20	DISEPL080O13	1.715
1 light wool NO DIM	1 led module 88 W - 12380 Lm - 2700 K	OD	OD	IP20	DISEPL080E13	1.715
1 light Kvadrat NO DIM	1 led module 88 W - 12380 Lm - 2700 K	OD	OD	IP20	DISEPL080I13	1.765
1 light pleated fabric NO DIM	1 led module 88 W - 12380 Lm - 2700 K	OD	OD	IP20	DISEPL080P13	1.815
1 light pleated ribbon fabric NO DIM	1 led module 88 W - 12380 Lm - 2700 K	OD	OD	IP20	DISEPL080R13	1.850
1 light cotton DIM DALI-Push DIM	1 led module 88 W - 12380 Lm - 2700 K	OD	OD	IP20	DISEPL080C15	1.705
1 light washable DIM DALI-Push DIM	1 led module 88 W - 12380 Lm - 2700 K	OD	OD	IP20	DISEPL080T15	1.795
1 light velvet DIM DALI-Push DIM	1 led module 88 W - 12380 Lm - 2700 K	OD	OD	IP20	DISEPL080O15	1.815
1 light wool DIM DALI-Push DIM	1 led module 88 W - 12380 Lm - 2700 K	OD	OD	IP20	DISEPL080E15	1.815
1 light Kvadrat DIM DALI-Push DIM	1 led module 88 W - 12380 Lm - 2700 K	OD	OD	IP20	DISEPL080I15	1.865
1 light pleated fabric DIM DALI-Push DIM	1 led module 88 W - 12380 Lm - 2700 K	OD	OD	IP20	DISEPL080P15	1.915
1 light pleated ribbon fabric DIM DALI-Push DIM	1 led module 88 W - 12380 Lm - 2700 K	OD	OD	IP20	DISEPL080R15	1.950

PRODUCTS: Discovolante

DESIGN: design: Paolo Grasselli 2004

Pendant, wall/ ceiling lamp available in cotton, washable, velvet, wool, Kvadrat, pleated and pleated ribbon fabrics.

On demand, lampshade available in For nature fabric (with surcharge).

One side frosted plex finishing underneath.

On demand, the pendant lamp can have a top protective disk in plex, usable only with LED bulbs or modules, with surcharge as per price list.

Symbol Index  → • / present - / absent OD / On Demand

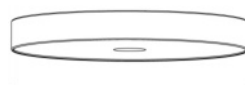

DISCOVOLANTE

Ceiling lamp - ø 100



Ø 100 cm
39.37"

15 cm
5.90"

DESCRIZIONE	SORGENTE			IP	CODICE	
4 lights cotton	4xE27max watt 42 W HES	OD	OD	IP20	DISEPL100C02	1.210
4 lights washable	4xE27max watt 42 W HES	OD	OD	IP20	DISEPL100T02	1.335
4 lights velvet	4xE27max watt 42 W HES	OD	OD	IP20	DISEPL100O02	1.355
4 lights wool	4xE27max watt 42 W HES	OD	OD	IP20	DISEPL100E02	1.355
4 lights Kvadrat	4xE27max watt 42 W HES	OD	OD	IP20	DISEPL100I02	1.410
4 lights pleated fabric	4xE27max watt 42 W HES	OD	OD	IP20	DISEPL100P02	1.490
4 lights pleated ribbon fabric	4xE27max watt 42 W HES	OD	OD	IP20	DISEPL100R02	1.535
1 light cotton NO DIM	1 led module 57 W - 8750 Lm - 2700 K	OD	OD	IP20	DISEPL100C17	1.470
1 light washable NO DIM	1 led module 57 W - 8750 Lm - 2700 K	OD	OD	IP20	DISEPL100T17	1.595
1 light velvet NO DIM	1 led module 57 W - 8750 Lm - 2700 K	OD	OD	IP20	DISEPL100O17	1.615
1 light wool NO DIM	1 led module 57 W - 8750 Lm - 2700 K	OD	OD	IP20	DISEPL100E17	1.615
1 light Kvadrat NO DIM	1 led module 57 W - 8750 Lm - 2700 K	OD	OD	IP20	DISEPL100I17	1.675
1 light pleated fabric NO DIM	1 led module 57 W - 8750 Lm - 2700 K	OD	OD	IP20	DISEPL100P17	1.755
1 light pleated ribbon fabric NO DIM	1 led module 57 W - 8750 Lm - 2700 K	OD	OD	IP20	DISEPL100R17	1.795
1 light cotton DIM TRIAC	1 led module 57 W - 8750 Lm - 2700 K	OD	OD	IP20	DISEPL100C19	1.545
1 light washable DIM TRIAC	1 led module 57 W - 8750 Lm - 2700 K	OD	OD	IP20	DISEPL100T19	1.670
1 light velvet DIM TRIAC	1 led module 57 W - 8750 Lm - 2700 K	OD	OD	IP20	DISEPL100O19	1.690
1 light wool DIM TRIAC	1 led module 57 W - 8750 Lm - 2700 K	OD	OD	IP20	DISEPL100E19	1.690
1 light Kvadrat DIM TRIAC	1 led module 57 W - 8750 Lm - 2700 K	OD	OD	IP20	DISEPL100I19	1.750
1 light pleated fabric DIM TRIAC	1 led module 57 W - 8750 Lm - 2700 K	OD	OD	IP20	DISEPL100P19	1.825
1 light pleated ribbon fabric DIM TRIAC	1 led module 57 W - 8750 Lm - 2700 K	OD	OD	IP20	DISEPL100R19	1.870

PRODUCTS: Discovolante

DESIGN: design: Paolo Grasselli 2004

Pendant, wall/ ceiling lamp available in cotton, washable, velvet, wool, Kvadrat, pleated and pleated ribbon fabrics.

On demand, lampshade available in For nature fabric (with surcharge).

One side frosted plex finishing underneath.



On demand, the pendant lamp can have a top protective disk in plex, usable only with LED bulbs or modules, with surcharge as per price list.

Symbol Index  → • / present - / adsent OD / On Demand

DISCOVOLANTE

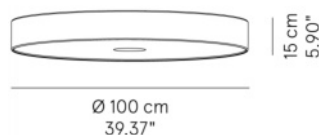
Ceiling lamp - ø 100



DESCRIZIONE	SORGENTE			IP	CODICE	
1 light cotton DIM DALI-Push DIM	1 led module 57 W - 8750 Lm - 2700 K	OD	OD	IP20	DISEPL100C18	1.595
1 light washable DIM DALI-Push DIM	1 led module 57 W - 8750 Lm - 2700 K	OD	OD	IP20	DISEPL100T18	1.720
1 light velvet DIM DALI-Push DIM	1 led module 57 W - 8750 Lm - 2700 K	OD	OD	IP20	DISEPL100O18	1.745
1 light wool DIM DALI-Push DIM	1 led module 57 W - 8750 Lm - 2700 K	OD	OD	IP20	DISEPL100E18	1.745
1 light Kvadrat DIM DALI-Push DIM	1 led module 57 W - 8750 Lm - 2700 K	OD	OD	IP20	DISEPL100I18	1.800
1 light pleated fabric DIM DALI-Push DIM	1 led module 57 W - 8750 Lm - 2700 K	OD	OD	IP20	DISEPL100P18	1.880
1 light pleated ribbon fabric DIM DALI-Push DIM	1 led module 57 W - 8750 Lm - 2700 K	OD	OD	IP20	DISEPL100R18	1.920
1 light cotton NO DIM	1 led module 88 W - 12380 Lm - 2700 K	OD	OD	IP20	DISEPL100C13	1.815
1 light washable NO DIM	1 led module 88 W - 12380 Lm - 2700 K	OD	OD	IP20	DISEPL100T13	1.945
1 light velvet NO DIM	1 led module 88 W - 12380 Lm - 2700 K	OD	OD	IP20	DISEPL100O13	1.965
1 light wool NO DIM	1 led module 88 W - 12380 Lm - 2700 K	OD	OD	IP20	DISEPL100E13	1.965
1 light Kvadrat NO DIM	1 led module 88 W - 12380 Lm - 2700 K	OD	OD	IP20	DISEPL100I13	2.020
1 light pleated fabric NO DIM	1 led module 88 W - 12380 Lm - 2700 K	OD	OD	IP20	DISEPL100P13	2.100
1 light pleated ribbon fabric NO DIM	1 led module 88 W - 12380 Lm - 2700 K	OD	OD	IP20	DISEPL100R13	2.140
1 light cotton DIM DALI-Push DIM	1 led module 88 W - 12380 Lm - 2700 K	OD	OD	IP20	DISEPL100C15	1.915
1 light washable DIM DALI-Push DIM	1 led module 88 W - 12380 Lm - 2700 K	OD	OD	IP20	DISEPL100T15	2.040
1 light velvet DIM DALI-Push DIM	1 led module 88 W - 12380 Lm - 2700 K	OD	OD	IP20	DISEPL100O15	2.065
1 light wool DIM DALI-Push DIM	1 led module 88 W - 12380 Lm - 2700 K	OD	OD	IP20	DISEPL100E15	2.065
1 light Kvadrat DIM DALI-Push DIM	1 led module 88 W - 12380 Lm - 2700 K	OD	OD	IP20	DISEPL100I15	2.120
1 light pleated fabric DIM DALI-Push DIM	1 led module 88 W - 12380 Lm - 2700 K	OD	OD	IP20	DISEPL100P15	2.200
1 light pleated ribbon fabric DIM DALI-Push DIM	1 led module 88 W - 12380 Lm - 2700 K	OD	OD	IP20	DISEPL100R15	2.240

NOTE: on demand, LED modules are also available in 3000K and 4000K, without surcharge.

-

0

PRODUCTS: Florinda

DESIGN: design: Romano + Menegon 2010

Pendant, ceiling and wall lamp in hand-finished pleated or pleated ribbon fabric.

Symbol Index  → • / present - / adsent OD / On Demand

FLORINDA

Pendant lamp

DESCRIZIONE

SORGENTE



IP

CODICE

1 lampshade pleated fabric

1xE27max watt 70 W HES

• OD IP20 FLOESO001P01 515

1 lampshade pleated ribbon fabric

1xE27max watt 70 W HES

OD OD IP20 FLOESO001R01 515

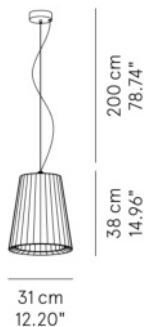

Pendant lamp

3 lampshades pleated fabric

3xE27max watt 70 W HES

• OD IP20 FLOESO003P01 1.640

3 lampshades pleated ribbon fabric

3xE27max watt 70 W HES

OD OD IP20 FLOESO003R01 1.640



PRODUCTS: Florinda

DESIGN: design: Romano + Menegon 2010

Pendant, ceiling and wall lamp in hand-finished pleated or pleated ribbon fabric.

Symbol Index  → • / present - / absent OD / On Demand

FLORINDA

DESCRIZIONE

SORGENTE



IP

CODICE

Pendant lamp

6+1 lampshades pleated fabric (double lighting)

6xE27 + 1xE14max watt 6 X 70 W + 1 X 42 W HES

• OD IP20 FLOESO006P01 3.320

6+1 lampshades pleated ribbon fabric (double lighting)

6xE27 + 1xE14max watt 6 X 70 W + 1 X 42 W HES

OD OD IP20 FLOESO006R01 3.320

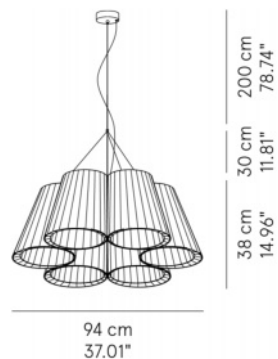

Pendant lamp

12+1 lampshades pleated fabric (double lighting)

12xE27 + 3xmax watt 12X70 W HES + 3X42 W HES

OD OD IP20 FLOESO012P02 8.495

12+1 lampshades pleated ribbon fabric (double lighting)

12xE27 + 3xmax watt 12X70 W HES + 3X42 W HES

OD OD IP20 FLOESO012R02 8.495

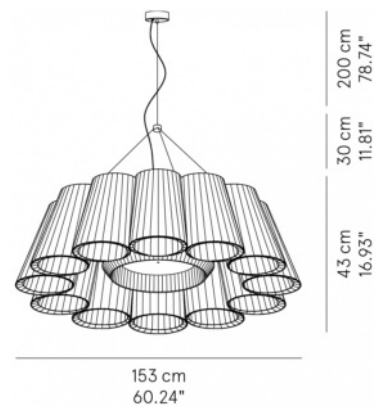

PRODUCTS: Florinda

DESIGN: design: Romano + Menegon 2010

Pendant, ceiling and wall lamp in hand-finished pleated or pleated ribbon fabric.

Symbol Index  → • / present - / absent OD / On Demand

FLORINDA

DESCRIZIONE

SORGENTE



IP

CODICE

Ceiling lamp

3 lampshades pleated fabric

3xE27max watt 70 W HES

• OD IP20 FLOEPL003P01 1.640

3 lampshades pleated ribbon fabric

3xE27max watt 70 W HES

OD OD IP20 FLOEPL003R01 1.640

10 cm
3.94"



41 cm
16.15"

63 cm
24.80"

Ceiling lamp

6 +1 lampshades pleated fabric (double lighting)

6xE27 + 1xE14max watt 6 X 70 W + 1 X 42 W HES

• OD IP20 FLOEPL006P01 3.275

6 +1 lampshades pleated ribbon fabric (double lighting)

6xE27 + 1xE14max watt 6 X 70 W + 1 X 42 W HES

OD OD IP20 FLOEPL006R01 3.275

14,5 cm
5.71"



41 cm
16.15"

94 cm
37.01"

PRODUCTS: Florinda

DESIGN: design: Romano + Menegon 2010

Pendant, ceiling and wall lamp in hand-finished pleated or pleated ribbon fabric.

Symbol Index  → • / present - / absent OD / On Demand

FLORINDA

DESCRIZIONE

SORGENTE



IP

CODICE

Ceiling lamp

12 +1 lampshades pleated fabric (double lighting)

12xE27 + 3xmax watt 12X70 W HES + 3X42 W HES

OD

OD

IP20

FLOEPL012P02

8.625

12 +1 lampshades pleated ribbon fabric (double lighting)

12xE27 + 3xmax watt 12X70 W HES + 3X42 W HES

OD

OD

IP20

FLOEPL012R02

8.625

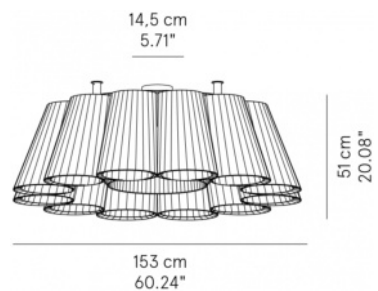

Wall lamp

Wall lamp pleated fabric

2xE27max watt 42 W HES

•

OD

IP20

FLOEAP002P01

415

Wall lamp pleated ribbon fabric

2xE27max watt 42 W HES

OD

OD

IP20

FLOEAP002R01

415

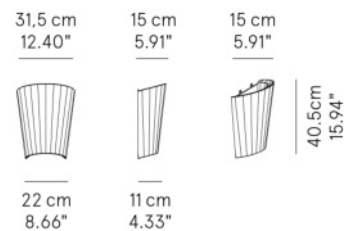

PRODUCTS: Florinda Desnuda

DESIGN: design: Romano + Menegon 2015

Pendant and ceiling lamp. Metal structure in matt white or black and in galvanic finishes brass and copper.

Symbol Index  → • / present - / absent OD / On Demand

FLORINDA DESNUDA DESCRIZIONE

Pendant lamp

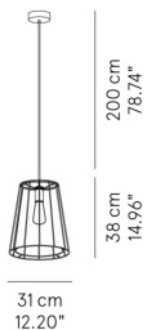

1 lampshade - matt white 9010

SORGENTE

1xE27max watt 70 W HES



IP

CODICE

• OD IP20 FLDESO001G01 300

1 lampshade - matt black

1xE27max watt 70 W HES

• OD IP20 FLDESO001G02 300

1 lampshade - glossy copper finishing

1xE27max watt 70 W HES

• OD IP20 FLDESO001G05 370

1 lampshade - glossy brass finishing

1xE27max watt 70 W HES

• OD IP20 FLDESO001G06 370

Kit 1 light bulb E27 Pear shape LED 7W 2300K (DIM)

LMPLEDE27KIT01P 40

Pendant lamp

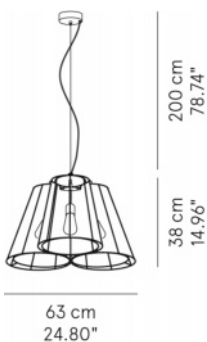

3 lampshades - matt white 9010

3xE27max watt 70 W HES

• OD IP20 FLDESO003G01 935

3 lampshades - matt black

3xE27max watt 70 W HES

• OD IP20 FLDESO003G02 935

3 lampshades - glossy copper finishing

3xE27max watt 70 W HES

• OD IP20 FLDESO003G05 1.375

3 lampshades - glossy brass finishing

3xE27max watt 70 W HES

• OD IP20 FLDESO003G06 1.375

Kit 3 x light bulbs E27 Pear shape LED 7W 2300K (DIM)

LMPLEDE27KIT03P 125

PRODUCTS: Florinda Desnuda

DESIGN: design: Romano + Menegon 2015

Pendant and ceiling lamp. Metal structure in matt white or black and in galvanic finishes brass and copper.

Symbol Index  → • / present - / adsent OD / On Demand

FLORINDA DESNUDA DESCRIZIONE

Pendant lamp



94 cm
37.01"

200 cm
78.74"
30 cm
11.81"
38 cm
14.96"

6 lampshades - matt white 9010

SORGENTE

6xE27max watt 70 W HES



IP

CODICE

• OD IP20 FLDESO006G01 1.700

6 lampshades - matt black

6xE27max watt 70 W HES

• OD IP20 FLDESO006G02 1.700

6 lampshades - glossy copper finishing

6xE27max watt 70 W HES

• OD IP20 FLDESO006G05 2.980

6 lampshades - glossy brass finishing

6xE27max watt 70 W HES

• OD IP20 FLDESO006G06 2.980

Kit 6 x light bulbs E27 Pear shape LED 7W 2300K (DIM)

LMPLEDE27KIT06P 250

Pendant lamp



153 cm
60.24"

200 cm
78.74"
30 cm
11.81"
43 cm
16.93"

12 lampshades - matt white 9010

12xE27max watt 70 W HES

• OD IP20 FLDESO012G01 4.360

12 lampshades - matt black

12xE27max watt 70 W HES

• OD IP20 FLDESO012G02 4.360

12 lampshades - glossy copper finishing

12xE27max watt 70 W HES

• OD IP20 FLDESO012G05 7.090

12 lampshades - glossy brass finishing

12xE27max watt 70 W HES

• OD IP20 FLDESO012G06 7.090

Kit 12 x light bulbs E27 Pear shape LED 7W 2300K (DIM)

LMPLEDE27KIT12P 505

PRODUCTS: Florinda Desnuda

DESIGN: design: Romano + Menegon 2015

Pendant and ceiling lamp. Metal structure in matt white or black and in galvanic finishes brass and copper.

Symbol Index  → • / present - / adsent OD / On Demand

FLORINDA DESNUDA DESCRIZIONE

Ceiling lamp

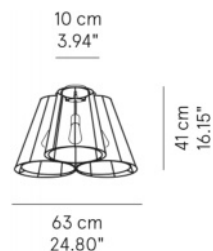

3 lampshades - matt white 9010

SORGENTE

3xE27max watt 70 W HES



IP

CODICE

• / present	- / adsent	OD / On Demand			
•	OD	IP20	FLDEPL003G01	945	
•	OD	IP20	FLDEPL003G02	945	
•	OD	IP20	FLDEPL003G05	1.450	
•	OD	IP20	FLDEPL003G06	1.450	

3 lampshades - matt black

3xE27max watt 70 W HES

3 lampshades - glossy copper finishing

3xE27max watt 70 W HES

3 lampshades - glossy brass finishing

3xE27max watt 70 W HES

Kit 3 x light bulbs E27 Pear shape LED 7W 2300K (DIM)

LMPLEDE27KIT03P 125

Ceiling lamp

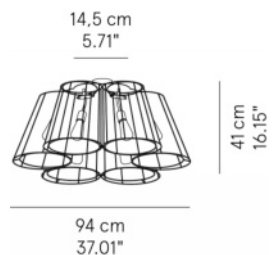

6 lampshades - matt white 9010

6xE27max watt 70 W HES

•	OD	IP20	FLDEPL006G01	1.775	
•	OD	IP20	FLDEPL006G02	1.775	
•	OD	IP20	FLDEPL006G05	3.100	
•	OD	IP20	FLDEPL006G06	3.100	

6 lampshades - matt black

6xE27max watt 70 W HES

6 lampshades - glossy copper finishing

6xE27max watt 70 W HES

6 lampshades - glossy brass finishing

6xE27max watt 70 W HES



Kit 6 x light bulbs E27 Pear shape LED 7W 2300K (DIM)

LMPLEDE27KIT06P 250

PRODUCTS: Florinda Desnuda

DESIGN: design: Romano + Menegon 2015

Pendant and ceiling lamp. Metal structure in matt white or black and in galvanic finishes brass and copper.

Symbol Index   → • / present - / adsent OD / On Demand

FLORINDA DESNUDA DESCRIZIONE

SORGENTE



IP

CODICE

Ceiling lamp

12 lampshades - matt white 9010

12xE27max watt 70 W HES

• OD IP20 FLDEPL0012G01 4.465

12 lampshades - matt black

12xE27max watt 70 W HES

• OD IP20 FLDEPL0012G02 4.465

12 lampshades - glossy copper finishing

12xE27max watt 70 W HES

• OD IP20 FLDEPL0012G05 7.245

12 lampshades - glossy brass finishing

12xE27max watt 70 W HES

• OD IP20 FLDEPL0012G06 7.245

Kit 12 x light bulbs E27 Pear shape LED 7W 2300K (DIM)

LMPLEDE27KIT12P 505

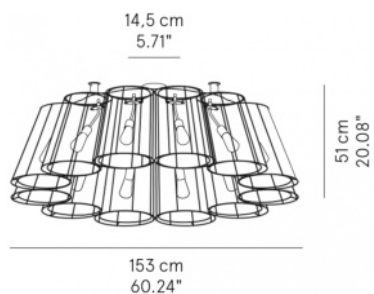

PRODUCTS: Frisé

DESIGN: design: Francesca Smiraglia 2023

Pendant lamp with double light emission, lampshade available in velvet, wool and For nature fabrics.

Metal structure painted white and black or in Deluxe finishing matt gold.

Lamp with acoustic comfort features.

Symbol Index  → • / present - / adsent OD / On Demand

FRISÉ

Pendant lamp D.75

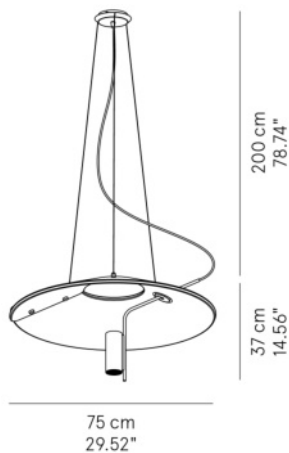

DESCRIZIONE

SORGENTE



IP

CODICE

Structure white diffuser velvet	2xGU10max watt 28W HES	•	OD	IP20	FRIESO075O01	2.075
Black structure diffuser velvet	2xGU10max watt 28W HES	•	OD	IP20	FRIESO075O02	2.075
Structure matt gold diffuser velvet	2xGU10max watt 28W HES	•	OD	IP20	FRIESO075O03	2.185
Structure white diffuser wool	2xGU10max watt 28W HES	•	OD	IP20	FRIESO075E01	2.185
Black structure diffuser wool	2xGU10max watt 28W HES	•	OD	IP20	FRIESO075E02	2.185
Structure matt gold diffuser wool	2xGU10max watt 28W HES	•	OD	IP20	FRIESO075E03	2.315
Structure white diffuser For nature	2xGU10max watt 28W HES	•	OD	IP20	FRIESO075Q01	2.405
Black structure diffuser For nature	2xGU10max watt 28W HES	•	OD	IP20	FRIESO075Q02	2.405
Structure matt gold diffuser For nature	2xGU10max watt 28W HES	•	OD	IP20	FRIESO075Q03	2.535

PRODUCTS: Frisé

DESIGN: design: Francesca Smiraglia 2023

Pendant lamp with double light emission, lampshade available in velvet, wool and For nature fabrics.

Metal structure painted white and black or in Deluxe finishing matt gold.

Lamp with acoustic comfort features.

Symbol Index  → • / present - / adsent OD / On Demand

FRISÉ

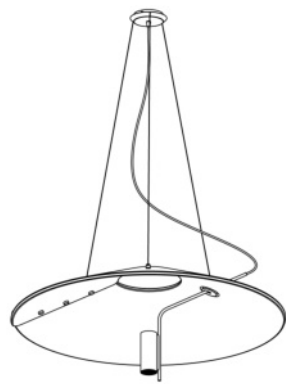

Pendant lamp D.100



100 cm
39.37"

200 cm
78.74"

43 cm
16.92"

DESCRIZIONE	SORGENTE			IP	CODICE	
Structure white diffuser velvet	2xGU10max watt 28W HES	•	OD	IP20	FRIESO100O01	2.455
Black structure diffuser velvet	2xGU10max watt 28W HES	•	OD	IP20	FRIESO100O02	2.455
Structure matt gold diffuser velvet	2xGU10max watt 28W HES	•	OD	IP20	FRIESO100O03	2.590
Structure white diffuser wool	2xGU10max watt 28W HES	•	OD	IP20	FRIESO100E01	2.620
Black structure diffuser wool	2xGU10max watt 28W HES	•	OD	IP20	FRIESO100E02	2.620
Structure matt gold diffuser wool	2xGU10max watt 28W HES	•	OD	IP20	FRIESO100E03	2.750
Structure white diffuser For nature	2xGU10max watt 28W HES	•	OD	IP20	FRIESO100Q01	2.840
Black structure diffuser For nature	2xGU10max watt 28W HES	•	OD	IP20	FRIESO100Q02	2.840
Structure matt gold diffuser For nature	2xGU10max watt 28W HES	•	OD	IP20	FRIESO100Q03	2.970

PRODUCTS: Galileo

DESIGN: design: Bellucci Mazzoni Progetti 2022

Pendant, wall and floor lamp.

Metal structure painted in white, lead grey, bronze and matt gold.

Diffused light.

Symbol Index  → • / present - / adsent OD / On Demand

GALILEO

Pendant lamp - D. 80 x L.125

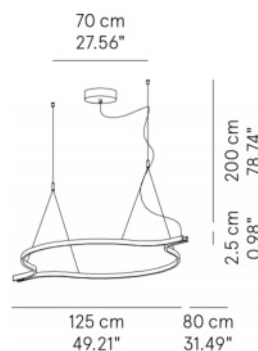

DESCRIZIONE

SORGENTE



IP

CODICE

Pendant lamp white, lead grey or bronze NO DIM	1 led module 44W - 5500 Lm - 3000 K - >80	•	OD	IP20	GALES0080G01	1.530
Pendant lamp matt gold NO DIM	1 led module 44W - 5500 Lm - 3000 K - >80	•	OD	IP20	GALES0080G02	2.130
Pendant lamp white, lead grey or bronze DIM TRIAC	1 led module 44W - 5500 Lm - 3000 K - >80	•	OD	IP20	GALES0080G03	1.630
Pendant lamp matt gold DIM TRIAC	1 led module 44W - 5500 Lm - 3000 K - >80	•	OD	IP20	GALES0080G04	2.225
Pendant lamp white, lead grey or bronze DIM DALI-Push DIM	1 led module 44W - 5500 Lm - 3000 K - >80	•	OD	IP20	GALES0080G05	1.670
Pendant lamp matt gold DIM DALI-Push DIM	1 led module 44W - 5500 Lm - 3000 K - >80	•	OD	IP20	GALES0080G06	2.275

Pendant lamp - D. 100 x L.156

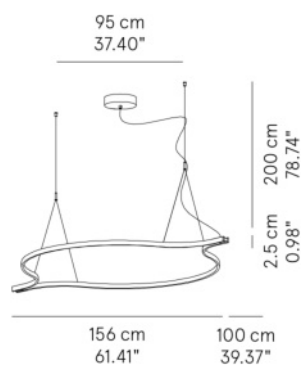

Pendant lamp white, lead grey or bronze NO DIM	1 led module 56W - 7100 Lm - 3000 K - >80	•	OD	IP20	GALES0100G01	1.690
Pendant lamp matt gold NO DIM	1 led module 56W - 7100 Lm - 3000 K - >80	•	OD	IP20	GALES0100G02	2.345
Pendant lamp white, lead grey or bronze DIM TRIAC	1 led module 56W - 7100 Lm - 3000 K - >80	•	OD	IP20	GALES0100G03	1.790
Pendant lamp matt gold DIM TRIAC	1 led module 56W - 7100 Lm - 3000 K - >80	•	OD	IP20	GALES0100G04	2.445
Pendant lamp white, lead grey or bronze DIM DALI-Push DIM	1 led module 56W - 7100 Lm - 3000 K - >80	•	OD	IP20	GALES0100G05	1.860
Pendant lamp matt gold DIM DALI-Push DIM	1 led module 56W - 7100 Lm - 3000 K - >80	•	OD	IP20	GALES0100G06	2.510

PRODUCTS: Galileo

DESIGN: design: Bellucci Mazzoni Progetti 2022

Pendant, wall and floor lamp.

Metal structure painted in white, lead grey, bronze and matt gold.



Diffused light.

Symbol Index  → • / present - / absent OD / On Demand

GALILEO

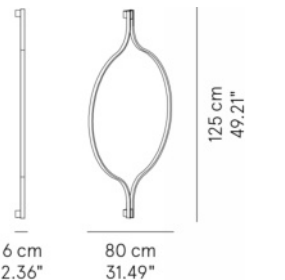
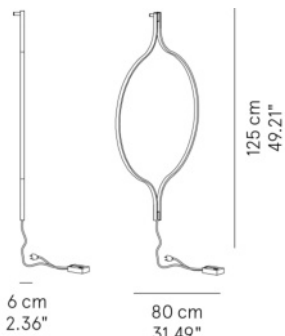
Wall lamp - D. 80 x L.125



DESCRIZIONE	SORGENTE			IP	CODICE	
Wall lamp white, lead grey or bronze DIM Plug	1 led module 29W - 3670 Lm - 3000 K - >80	•	OD	IP20	GALEAP080G01	1.515
Wall lamp matt gold DIM Plug	1 led module 29W - 3670 Lm - 3000 K - >80	•	OD	IP20	GALEAP080G02	2.120
Wall lamp white, lead grey or bronze NO DIM Remote	1 led module 44W - 5500 Lm - 3000 K - >80	•	OD	IP20	GALEAP080G03	1.495
Wall lamp matt gold NO DIM Remote	1 led module 44W - 5500 Lm - 3000 K - >80	•	OD	IP20	GALEAP080G04	2.095
Wall lamp white, lead grey or bronze DIM TRIAC Remote	1 led module 44W - 5500 Lm - 3000 K - >80	•	OD	IP20	GALEAP080G05	1.540
Wall lamp matt gold DIM TRIAC Remote	1 led module 44W - 5500 Lm - 3000 K - >80	•	OD	IP20	GALEAP080G06	2.140
Wall lamp white, lead grey or bronze DIM DALI-Push DIM Remote	1 led module 44W - 5500 Lm - 3000 K - >80	•	OD	IP20	GALEAP080G07	1.585
Wall lamp matt gold DIM DALI-Push DIM Remote	1 led module 44W - 5500 Lm - 3000 K - >80	•	OD	IP20	GALEAP080G08	2.185



PRODUCTS: Galileo

DESIGN: design: Bellucci Mazzoni Progetti 2022

Pendant, wall and floor lamp.

Metal structure painted in white, lead grey, bronze and matt gold.

Diffused light.

Symbol Index   → • / present - / adsent OD / On Demand

GALILEO

DESCRIZIONE

SORGENTE



IP

CODICE

Floor lamp - H. 180

Floor lamp white, lead grey or bronze DIM Plug

1 led module 22W - 2755 Lm - 3000 K - >80

• OD IP20 GALEPT180G01 1.365

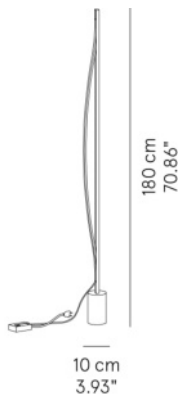

PRODUCTS: Galileo Longue

DESIGN: design: Bellucci Mazzoni Progetti 2022

Pendant and wall lamp.

Metal structure painted in white, lead grey, bronze and matt gold.

Diffused light.

Symbol Index  → • / present - / adsent OD / On Demand

GALILEO LONGUE

Pendant lamp - L. 120

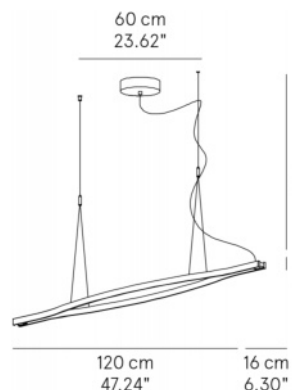

Pendant lamp white, lead grey or bronze NO DIM

SORGENTE

1 led module 32 W - 4030 Lm - 3000 K



IP

CODICE

• OD IP20 GLLESO120G01 1.405

Pendant lamp matt gold NO DIM

1 led module 32 W - 4030 Lm - 3000 K

• OD IP20 GLLESO120G02 1.770

Pendant lamp white, lead grey or bronze DIM TRIAC

1 led module 32 W - 4030 Lm - 3000 K

• OD IP20 GLLESO120G03 1.475

Pendant lamp matt gold DIM TRIAC

1 led module 32 W - 4030 Lm - 3000 K

• OD IP20 GLLESO120G04 1.830

Pendant lamp white, lead grey or bronze DIM DALI-Push DIM

1 led module 32 W - 4030 Lm - 3000 K

• OD IP20 GLLESO120G05 1.560

Pendant lamp matt gold DIM DALI-Push DIM

1 led module 32 W - 4030 Lm - 3000 K

• OD IP20 GLLESO120G06 1.920

Pendant lamp - L. 145

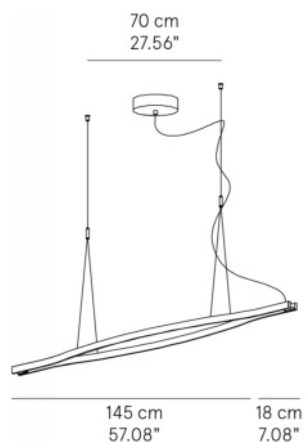

Pendant lamp white, lead grey or bronze NO DIM

1 led module 40W - 5000 Lm - 3000 K - >80

• OD IP20 GLLESO145G01 1.515

Pendant lamp matt gold NO DIM

1 led module 40W - 5000 Lm - 3000 K - >80

• OD IP20 GLLESO145G02 1.955

Pendant lamp white, lead grey or bronze DIM TRIAC

1 led module 40W - 5000 Lm - 3000 K - >80

• OD IP20 GLLESO145G03 1.585

Pendant lamp matt gold DIM TRIAC

1 led module 40W - 5000 Lm - 3000 K - >80

• OD IP20 GLLESO145G04 2.020

Pendant lamp white, lead grey or bronze DIM DALI-Push DIM

1 led module 40W - 5000 Lm - 3000 K - >80

• OD IP20 GLLESO145G05 1.670

Pendant lamp matt gold DIM DALI-Push DIM

1 led module 40W - 5000 Lm - 3000 K - >80

• OD IP20 GLLESO145G06 2.105

PRODUCTS: Galileo Longue

DESIGN: design: Bellucci Mazzoni Progetti 2022

Pendant and wall lamp.

Metal structure painted in white, lead grey, bronze and matt gold.



Diffused light.

Symbol Index  → • / present - / absent OD / On Demand

GALILEO LONGUE

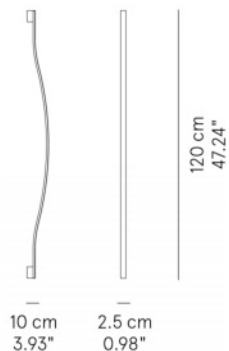
Wall lamp - L. 120



DESCRIZIONE	SORGENTE			IP	CODICE	
Wall lamp white, lead grey or bronze NO DIM Remote	1 led module 16 W - 2000 Lm - 3000 K - >80	•	OD	IP20	GLLEAP120G01	840
Wall lamp matt gold NO DIM Remote	1 led module 16 W - 2000 Lm - 3000 K - >80	•	OD	IP20	GLLEAP120G02	1.080
Wall lamp white, lead grey or bronze DIM TRIAC Remote	1 led module 16 W - 2000 Lm - 3000 K - >80	•	OD	IP20	GLLEAP120G03	880
Wall lamp matt gold DIM TRIAC Remote	1 led module 16 W - 2000 Lm - 3000 K - >80	•	OD	IP20	GLLEAP120G04	1.125
Wall lamp white, lead grey or bronze DIM DALI-Push DIM Remote	1 led module 16 W - 2000 Lm - 3000 K - >80	•	OD	IP20	GLLEAP120G05	970
Wall lamp matt gold DIM DALI-Push DIM Remote	1 led module 16 W - 2000 Lm - 3000 K - >80	•	OD	IP20	GLLEAP120G06	1.215

Wall lamp - L. 145

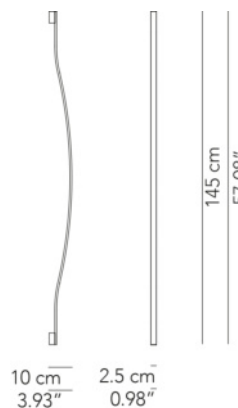

Wall lamp white, lead grey or bronze NO DIM Remote	1 led module 20W - 2500 Lm - 3000 K - >80	•	OD	IP20	GLLEAP145G01	870
Wall lamp matt gold NO DIM Remote	1 led module 20W - 2500 Lm - 3000 K - >80	•	OD	IP20	GLLEAP145G02	1.115
Wall lamp white, lead grey or bronze DIM TRIAC Remote	1 led module 20W - 2500 Lm - 3000 K - >80	•	OD	IP20	GLLEAP145G03	915
Wall lamp matt gold DIM TRIAC Remote	1 led module 20W - 2500 Lm - 3000 K - >80	•	OD	IP20	GLLEAP145G04	1.155
Wall lamp white, lead grey or bronze DIM DALI-Push DIM Remote	1 led module 20W - 2500 Lm - 3000 K - >80	•	OD	IP20	GLLEAP145G05	1.005
Wall lamp matt gold DIM DALI-Push DIM Remote	1 led module 20W - 2500 Lm - 3000 K - >80	•	OD	IP20	GLLEAP145G06	1.245

PRODUCTS: Geco

DESIGN: design: Paolo Grasselli 2019

Wall lamp with or without lampshade. Lampshade in cotton fabric.

On demand, lampshade available in Kvadrat and pleated fabrics (with surcharge).

Metal structure painted in white, black or bronze colour and in Deluxe finishing matt gold.

Symbol Index  → • / present - / adsent OD / On Demand

GECO

Wall lamp - s/paralume

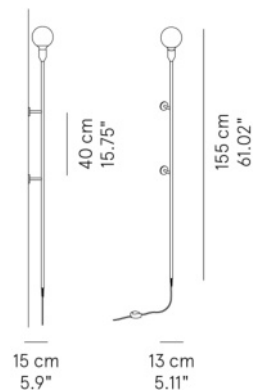

DESCRIZIONE

SORGENTE



IP

CODICE

Wall lamp white	1xE27max watt 42 W HES	•	OD	IP20	GECEAP160G01	545
Wall lamp black	1xE27max watt 42 W HES	•	OD	IP20	GECEAP160G02	545
Wall lamp bronze	1xE27max watt 42 W HES	•	OD	IP20	GECEAP160G07	545
Wall lamp matt gold	1xE27max watt 42 W HES	•	OD	IP20	GECEAP160G06	635

Wall lamp - c/paralume

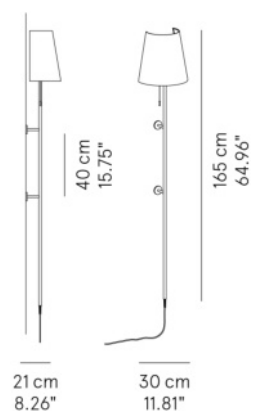

Wall lamp white cotton	1xE27max watt 42 W HES	OD	OD	IP20	GECEAP160C01	740
Wall lamp black cotton	1xE27max watt 42 W HES	OD	OD	IP20	GECEAP160C02	740
Wall lamp bronze cotton	1xE27max watt 42 W HES	OD	OD	IP20	GECEAP160C07	740
Wall lamp matt gold cotton	1xE27max watt 42 W HES	OD	OD	IP20	GECEAP160C06	830

PRODUCTS: Geco

DESIGN: design: Paolo Grasselli 2019

Wall lamp with or without lampshade. Lampshade in cotton fabric.

On demand, lampshade available in Kvadrat and pleated fabrics (with surcharge).

Metal structure painted in white, black or bronze colour and in Deluxe finishing matt gold.

Symbol Index  → • / present - / absent OD / On Demand

GECO

DESCRIZIONE

SORGENTE



IP

CODICE

Wall lamp - without plug - s/paralume

Wall lamp white

1xE27max watt 42 W HES

• OD IP20 GECEAP160G11 555

Wall lamp black

1xE27max watt 42 W HES

• OD IP20 GECEAP160G12 555

Wall lamp bronze

1xE27max watt 42 W HES

• OD IP20 GECEAP160G17 555

Wall lamp matt gold

1xE27max watt 42 W HES

• OD IP20 GECEAP160G16 645

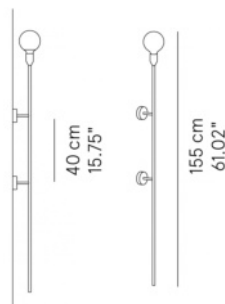

17 cm
6.69"

13 cm
5.11"

Wall lamp - without plug - c/paralume

Wall lamp white cotton

1xE27max watt 42 W HES

OD OD IP20 GECEAP160C11 730

Wall lamp black cotton

1xE27max watt 42 W HES

OD OD IP20 GECEAP160C12 730

Wall lamp bronze cotton

1xE27max watt 42 W HES

OD OD IP20 GECEAP160C17 730

Wall lamp matt gold cotton

1xE27max watt 42 W HES

OD OD IP20 GECEAP160C16 820

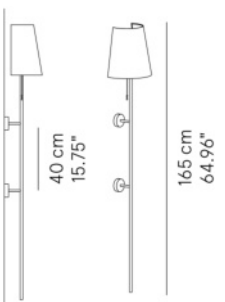

23 cm
9.05"

30 cm
11.81"

PRODUCTS: Gregory

DESIGN: design: Alfredo Chiaramonte 2024



Single or aggregable pendant lamps. Metal structure painted in white, black or bronze gold. Lampshade diffuser in cotton, wool and Kvadrat fabrics.

Symbol Index  → • / present - / adsent OD / On Demand

GREGORY

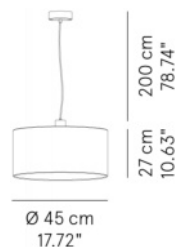
Pendant lamp - ø 45



DESCRIZIONE	SORGENTE			IP	CODICE	
Pendant lamp white ceiling rose cotton shade	1xE27max watt 42 W HES	•	OD	IP20	GREESO045C01	495
Pendant lamp black ceiling rose cotton shade	1xE27max watt 42 W HES	•	OD	IP20	GREESO045C02	495
Pendant lamp bronze gold ceiling rose cotton shade	1xE27max watt 42 W HES	•	OD	IP20	GREESO045C03	565
Pendant lamp white ceiling rose wool shade	1xE27max watt 42 W HES	•	OD	IP20	GREESO045E01	585
Pendant lamp black ceiling rose wool shade	1xE27max watt 42 W HES	•	OD	IP20	GREESO045E02	585
Pendant lamp bronze gold ceiling rose wool shade	1xE27max watt 42 W HES	•	OD	IP20	GREESO045E03	655
Pendant lamp white ceiling rose Kvadrat shade	1xE27max watt 42 W HES	•	OD	IP20	GREESO045I01	625
Pendant lamp black ceiling rose Kvadrat shade	1xE27max watt 42 W HES	•	OD	IP20	GREESO045I02	625
Pendant lamp bronze gold ceiling rose Kvadrat shade	1xE27max watt 42 W HES	•	OD	IP20	GREESO045I03	700

Pendant lamp - L 140

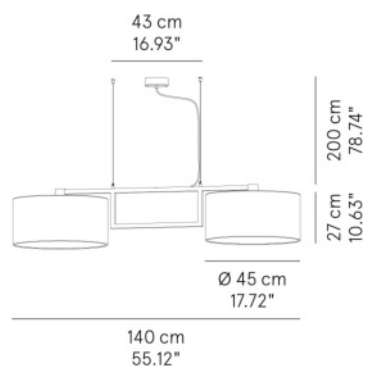

Pendant lamp white str./ ceiling rose cotton shade	2xE27max watt 42 W HES	•	OD	IP20	GREESO140C01	1.385
Pendant lamp black str./ ceiling rose cotton shade	2xE27max watt 42 W HES	•	OD	IP20	GREESO140C02	1.385
Pendant lamp bronze gold str./ ceiling rose cotton shade	2xE27max watt 42 W HES	•	OD	IP20	GREESO140C03	1.630
Pendant lamp white str./ ceiling rose wool shade	2xE27max watt 42 W HES	•	OD	IP20	GREESO140E01	1.565
Pendant lamp black str./ ceiling rose wool shade	2xE27max watt 42 W HES	•	OD	IP20	GREESO140E02	1.565
Pendant lamp bronze gold str./ ceiling rose wool shade	2xE27max watt 42 W HES	•	OD	IP20	GREESO140E03	1.805
Pendant lamp white str./ ceiling rose Kvadrat shade	2xE27max watt 42 W HES	•	OD	IP20	GREESO140I01	1.650
Pendant lamp black str./ ceiling rose Kvadrat shade	2xE27max watt 42 W HES	•	OD	IP20	GREESO140I02	1.650
Pendant lamp bronze gold str./ ceiling rose Kvadrat shade	2xE27max watt 42 W HES	•	OD	IP20	GREESO140I03	1.890

PRODUCTS: Gregory

DESIGN: design: Alfredo Chiaramonte 2024

Single or aggregable pendant lamps. Metal structure painted in white, black or bronze gold.
Lampshade diffuser in cotton, wool and Kvadrat fabrics.

Symbol Index  → • / present - / adsent OD / On Demand

GREGORY

Pendant lamp - L 165

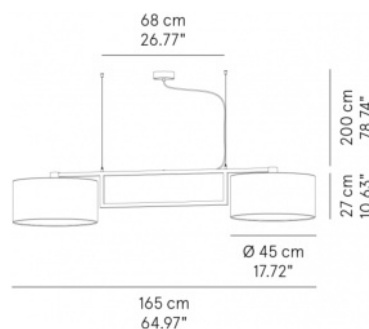

DESCRIZIONE	SORGENTE			IP	CODICE	
Pendant lamp white str./ ceiling rose cotton shade	2xE27max watt 42 W HES	•	OD	IP20	GREESO165C01	1.585
Pendant lamp black str./ ceiling rose cotton shade	2xE27max watt 42 W HES	•	OD	IP20	GREESO165C02	1.585
Pendant lamp bronze gold str./ ceiling rose cotton shade	2xE27max watt 42 W HES	•	OD	IP20	GREESO165C03	1.800
Pendant lamp white str./ ceiling rose wool shade	2xE27max watt 42 W HES	•	OD	IP20	GREESO165E01	1.765
Pendant lamp black str./ ceiling rose wool shade	2xE27max watt 42 W HES	•	OD	IP20	GREESO165E02	1.765
Pendant lamp bronze gold str./ ceiling rose wool shade	2xE27max watt 42 W HES	•	OD	IP20	GREESO165E03	1.980
Pendant lamp white str./ ceiling rose Kvadrat shade	2xE27max watt 42 W HES	•	OD	IP20	GREESO165I01	1.850
Pendant lamp black str./ ceiling rose Kvadrat shade	2xE27max watt 42 W HES	•	OD	IP20	GREESO165I02	1.850
Pendant lamp bronze gold str./ ceiling rose Kvadrat shade	2xE27max watt 42 W HES	•	OD	IP20	GREESO165I03	2.065

Pendant lamp - L 235

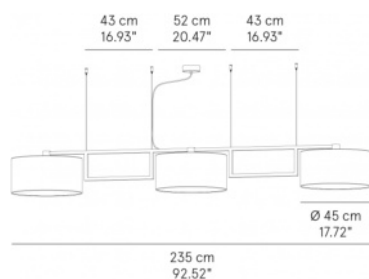

Pendant lamp white str./ ceiling rose cotton shade	3xE27max watt 42 W HES	•	OD	IP20	GREESO235C01	2.405
Pendant lamp black str./ ceiling rose cotton shade	3xE27max watt 42 W HES	•	OD	IP20	GREESO235C02	2.405
Pendant lamp bronze gold str./ ceiling rose cotton shade	3xE27max watt 42 W HES	•	OD	IP20	GREESO235C03	2.730
Pendant lamp white str./ ceiling rose wool shade	3xE27max watt 42 W HES	•	OD	IP20	GREESO235E01	2.670
Pendant lamp black str./ ceiling rose wool shade	3xE27max watt 42 W HES	•	OD	IP20	GREESO235E02	2.670
Pendant lamp bronze gold str./ ceiling rose wool shade	3xE27max watt 42 W HES	•	OD	IP20	GREESO235E03	3.000
Pendant lamp white str./ ceiling rose Kvadrat shade	3xE27max watt 42 W HES	•	OD	IP20	GREESO235I01	2.800
Pendant lamp black str./ ceiling rose Kvadrat shade	3xE27max watt 42 W HES	•	OD	IP20	GREESO235I02	2.800
Pendant lamp bronze gold str./ ceiling rose Kvadrat shade	3xE27max watt 42 W HES	•	OD	IP20	GREESO235I03	3.125

PRODUCTS: Gregory

DESIGN: design: Alfredo Chiaramonte 2024

Single or aggregable pendant lamps. Metal structure painted in white, black or bronze gold.
Lampshade diffuser in cotton, wool and Kvadrat fabrics.

Symbol Index  → • / present - / absent OD / On Demand

GREGORY

DESCRIZIONE

SORGENTE



IP

CODICE

Composition components: structure I. 90 Metal structure I. 90 white

• OD IP20 GREECM090G01 535

Metal structure I. 90 black

• OD IP20 GREECM090G02 535

Metal structure I. 90 bronze gold

• OD IP20 GREECM090G03 655

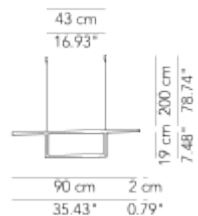

Composition components: structure I. 115 Metal structure I. 115 white

• OD IP20 GREECM115G01 590

Metal structure I. 115 black

• OD IP20 GREECM115G02 590

Metal structure I. 115 bronze gold

• OD IP20 GREECM115G03 720

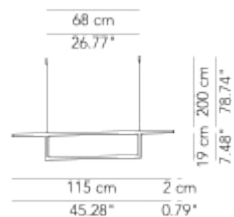

Composition components: ceiling rose Ceiling rose white painted

• OD IP20 GREERO110G01 105

Ceiling rose black painted

• OD IP20 GREERO110G02 105

Ceiling rose bronze gold painted



• OD IP20 GREERO110G03 140



PRODUCTS: Gregory

DESIGN: design: Alfredo Chiaramonte 2024

Single or aggregable pendant lamps. Metal structure painted in white, black or bronze gold.
Lampshade diffuser in cotton, wool and Kvadrat fabrics.

Symbol Index   → • / present - / adsent OD / On Demand

GREGORY

DESCRIZIONE

SORGENTE



IP

CODICE

Composition components: junction A

Metal junction type A white painted

• OD IP20 GREEDA005G01 210

Metal junction type A black painted

• OD IP20 GREEDA005G02 210

Metal junction type A bronze gold painted

• OD IP20 GREEDA005G03 230



Composition components: junction B

Metal junction type B white painted

• OD IP20 GREEDB005G01 210

Metal junction type B black painted

• OD IP20 GREEDB005G02 210

Metal junction type B bronze gold painted

• OD IP20 GREEDB005G03 230

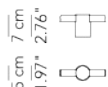

Composition components: junction C

Metal junction type C white painted

• OD IP20 GREEDC005G01 210

Metal junction type C black painted

• OD IP20 GREEDC005G02 210

Metal junction type C bronze gold painted

• OD IP20 GREEDC005G03 230



Composition components: junction D

Metal junction type D white painted

• OD IP20 GREEDD005G01 220

Metal junction type D black painted

• OD IP20 GREEDD005G02 220

Metal junction type D bronze gold painted

• OD IP20 GREEDD005G03 240





PRODUCTS: Gregory

DESIGN: design: Alfredo Chiamonte 2024

Single or aggregable pendant lamps. Metal structure painted in white, black or bronze gold.

Lampshade diffuser in cotton, wool and Kvadrat fabrics.

Symbol Index   → • / present - / adsent OD / On Demand

GREGORY

DESCRIZIONE

SORGENTE



IP

CODICE

Composition components: junction E

Metal junction type E white painted

• OD IP20 GREEDE005G01 240

Metal junction type E black painted

• OD IP20 GREEDE005G02 240

Metal junction type E bronze gold painted

• OD IP20 GREEDE005G03 265

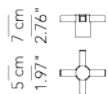

Composition components: lampshade

Lampshade d.45xh.22 cotton

• OD IP20 GREEPA045C01 240

Lampshade d.45xh.22 wool

• OD IP20 GREEPA045E01 330

Lampshade d.45xh.22 Kvadrat

• OD IP20 GREEPA045I01 375



Accessory

Opal plex finishing underneath

OD IP20 GREEPI045F01 45

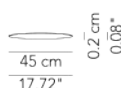

PRODUCTS: Hammer
DESIGN: Paolo Grasselli 2017



Pendant lamp, spotlight and recessed spotlight.
 Turned metal body painted in white or lead grey and in Deluxe finishes: brick, blue China and matt gold.

Symbol Index  → • / present - / adsent OD / On Demand

HAMMER

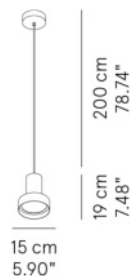
Pendant lamp ø 15



DESCRIZIONE	SORGENTE	  IP	CODICE	
Pendat lamp white or lead grey	1xGU10max watt 20 W HES	• OD IP20	HAMESO015G11	390
Pendant lamp Deluxe	1xGU10max watt 20 W HES	• OD IP20	HAMESO015G12	490
Pendat lamp white or lead grey NO DIM	1 led module 9 W - 830 Lm - 3000 K - >85	• OD IP20	HAMESO015G01	435
Pendant lamp Deluxe NO DIM	1 led module 9 W - 830 Lm - 3000 K - >85	• OD IP20	HAMESO015G02	535
Pendat lamp white or lead grey DIM TRIAC	1 led module 9 W - 830 Lm - 3000 K - >85	• OD IP20	HAMESO015G05	495
Pendant lamp Deluxe DIM TRIAC	1 led module 9 W - 830 Lm - 3000 K - >85	• OD IP20	HAMESO015G06	590
Pendant lamp white or lead grey DIM DALI-Push DIM	1 led module 9 W - 830 Lm - 3000 K - >85	• OD IP20	HAMESO015G03	565
Pendant lamp Deluxe DIM DALI-Push DIM	1 led module 9 W - 830 Lm - 3000 K - >85	• OD IP20	HAMESO015G04	665

Pendant lamp ø 18

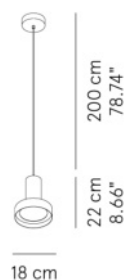

Pendat lamp white or lead grey	1xGU10max watt 20 W HES	• OD IP20	HAMESO018G11	405
Pendant lamp Deluxe	1xGU10max watt 20 W HES	• OD IP20	HAMESO018G12	505
Pendat lamp white or lead grey NO DIM	1 led module 12 W - 1110 Lm - 3000 K - >85	• OD IP20	HAMESO018G01	465
Pendant lamp Deluxe NO DIM	1 led module 12 W - 1110 Lm - 3000 K - >85	• OD IP20	HAMESO018G02	565
Pendat lamp white or lead grey DIM TRIAC	1 led module 12 W - 1110 Lm - 3000 K - >85	• OD IP20	HAMESO018G05	535
Pendant lamp Deluxe DIM TRIAC	1 led module 12 W - 1110 Lm - 3000 K - >85	• OD IP20	HAMESO018G06	635
Pendant lamp white or lead grey DIM DALI-Push DIM	1 led module 12 W - 1110 Lm - 3000 K - >85	• OD IP20	HAMESO018G03	590
Pendant lamp Deluxe DIM DALI-Push DIM	1 led module 12 W - 1110 Lm - 3000 K - >85	• OD IP20	HAMESO018G04	690

Accessory - Pendant lamps ø 15 e ø 18	Surcharge for ceiling rose in the same colour as Deluxe structure		ROS110003601	30
--	---	--	--------------	----

PRODUCTS: Hammer
DESIGN: Paolo Grasselli 2017

Pendant lamp, spotlight and recessed spotlight.



Turned metal body painted in white or lead grey and in Deluxe finishes: brick, blue China and matt gold.

Symbol Index  → • / present - / adsent OD / On Demand

HAMMER

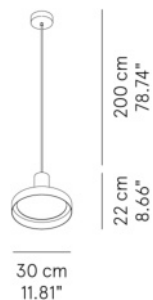
Pendant lamp ø 30



DESCRIZIONE	SORGENTE			IP	CODICE	
Pendat lamp white or lead grey NO DIM	1 led module 24 W - 2150 Lm - 3000 K - >85	•	OD	IP20	HAMESO030G01	600
Pendant lamp Deluxe NO DIM	1 led module 24 W - 2150 Lm - 3000 K - >85	•	OD	IP20	HAMESO030G02	710
Pendat lamp white or lead grey DIM TRIAC	1 led module 24 W - 2150 Lm - 3000 K - >85	•	OD	IP20	HAMESO030G05	710
Pendant lamp Deluxe DIM TRIAC	1 led module 24 W - 2150 Lm - 3000 K - >85	•	OD	IP20	HAMESO030G06	820
Pendant lamp white or lead grey DIM DALI-Push DIM	1 led module 24 W - 2150 Lm - 3000 K - >85	•	OD	IP20	HAMESO030G03	820
Pendant lamp Deluxe DIM DALI-Push DIM	1 led module 24 W - 2150 Lm - 3000 K - >85	•	OD	IP20	HAMESO030G04	930

Accessory - Pendant lamp ø 30

Surcharge for ceiling rose in the same colour as Deluxe structure					ROS160004201	35
---	--	--	--	--	--------------	----

Spotlight ø 15



Spotlight white or lead grey	1xGU10max watt 20 W HES	•	OD	IP20	HAMEFA015G11	305
Spotlight Deluxe	1xGU10max watt 20 W HES	•	OD	IP20	HAMEFA015G12	405
Spotlight white or lead grey NO DIM	1 led module 9 W - 830 Lm - 3000 K - >85	•	OD	IP20	HAMEFA015G01	360
Spotlight Deluxe NO DIM	1 led module 9 W - 830 Lm - 3000 K - >85	•	OD	IP20	HAMEFA015G02	455
Spotlight white or lead grey DIM TRIAC (NOTE remote driver)	1 led module 9 W - 830 Lm - 3000 K - >85	•	OD	IP20	HAMEFA015G05	425
Spotlight Deluxe DIM TRIAC (NOTE remote driver)	1 led module 9 W - 830 Lm - 3000 K - >85	•	OD	IP20	HAMEFA015G06	525
Spotlight white or lead grey DIM DALI	1 led module 9 W - 830 Lm - 3000 K - >85	•	OD	IP20	HAMEFA015G03	495
Spotlight Deluxe DIM DALI	1 led module 9 W - 830 Lm - 3000 K - >85	•	OD	IP20	HAMEFA015G04	590

PRODUCTS: Hammer
DESIGN: Paolo Grasselli 2017

Pendant lamp, spotlight and recessed spotlight.

Turned metal body painted in white or lead grey and in Deluxe finishes: brick, blue China and matt gold.

Symbol Index  → • / present - / absent OD / On Demand

HAMMER



Spotlight ø 18



18 cm
7.48"



18 cm
7.48"

DESCRIZIONE	SORGENTE			IP	CODICE	
Spotlight white or lead grey	1xGU10max watt 20 W HES	•	OD	IP20	HAMEFA018G11	325
Spotlight Deluxe	1xGU10max watt 20 W HES	•	OD	IP20	HAMEFA018G12	425
Spotlight white or lead grey NO DIM	1 led module 12 W - 1110 Lm - 3000 K - >85	•	OD	IP20	HAMEFA018G01	385
Spotlight Deluxe NO DIM	1 led module 12 W - 1110 Lm - 3000 K - >85	•	OD	IP20	HAMEFA018G02	485
Spotlight white or lead grey DIM TRIAC (NOTE remote driver)	1 led module 12 W - 1110 Lm - 3000 K - >85	•	OD	IP20	HAMEFA018G05	445
Spotlight Deluxe DIM TRIAC (NOTE remote driver)	1 led module 12 W - 1110 Lm - 3000 K - >85	•	OD	IP20	HAMEFA018G06	545
Spotlight white or lead grey DIM DALI	1 led module 12 W - 1110 Lm - 3000 K - >85	•	OD	IP20	HAMEFA018G03	515
Spotlight Deluxe DIM DALI	1 led module 12 W - 1110 Lm - 3000 K - >85	•	OD	IP20	HAMEFA018G04	610

PRODUCTS: Hammer
DESIGN: Paolo Grasselli 2017

Pendant lamp, spotlight and recessed spotlight.

Turned metal body painted in white or lead grey and in Deluxe finishes: brick, blue China and matt gold.

Symbol Index  → • / present - / absent OD / On Demand

HAMMER

Recessed spotlight ø 15



21 cm
8.26"

15 cm
5.90"



21 cm
8.26"

15 cm
5.90"

Recessed spotlight Hammer 15 – foro/hole Ø 13,5-15 cm

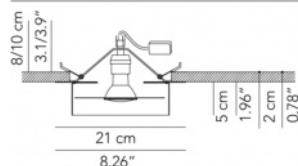

Recessed spotlight LED Hammer 15 – foro/hole Ø 13,5-15 cm

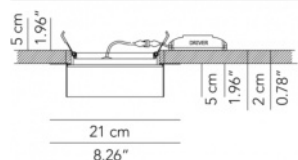

DESCRIZIONE

SORGENTE



IP

CODICE

Recessed spotlight white or lead grey	1xGU10max watt 20 W HES	•	-	IP20	HAMEIN015G11	270
Recessed spotlight Deluxe	1xGU10max watt 20 W HES	•	-	IP20	HAMEIN015G12	330
Recessed spotlight white or lead grey NO DIM	1 led module 9 W - 830 Lm - 3000 K - >85	•	-	IP20	HAMEIN015G01	280
Recessed spotlight Deluxe NO DIM	1 led module 9 W - 830 Lm - 3000 K - >85	•	-	IP20	HAMEIN015G02	345
Recessed spotlight white or lead grey DIM TRIAC	1 led module 9 W - 830 Lm - 3000 K - >85	•	-	IP20	HAMEIN015G05	345
Recessed spotlight Deluxe DIM TRIAC	1 led module 9 W - 830 Lm - 3000 K - >85	•	-	IP20	HAMEIN015G06	410
Recessed spotlight white or lead grey DIM DALI	1 led module 9 W - 830 Lm - 3000 K - >85	•	-	IP20	HAMEIN015G03	410
Recessed spotlight Deluxe DIM DALI	1 led module 9 W - 830 Lm - 3000 K - >85	•	-	IP20	HAMEIN015G04	475

PRODUCTS: Hammer
DESIGN: Paolo Grasselli 2017

Pendant lamp, spotlight and recessed spotlight.

Turned metal body painted in white or lead grey and in Deluxe finishes: brick, blue China and matt gold.

Symbol Index  → • / present - / absent OD / On Demand

HAMMER

Recessed spotlight ø 18



24 cm
9.44"

18 cm
7.08"



24 cm
9.44"

18 cm
7.08"

Recessed spotlight

Hammer 18 – foro/hole Ø 16-18 cm

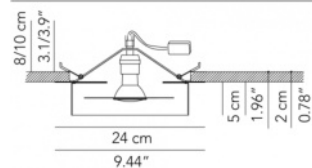

Recessed spotlight LED

Hammer 18 – foro/hole Ø 16-18 cm

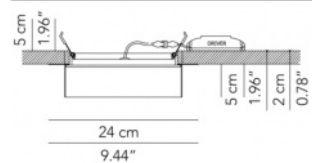

DESCRIZIONE

SORGENTE



IP

CODICE

Recessed spotlight white or lead grey	1xGU10max watt 20 W HES	•	-	IP20	HAMEIN018G11	275
Recessed spotlight Deluxe	1xGU10max watt 20 W HES	•	-	IP20	HAMEIN018G12	335
Recessed spotlight white or lead grey NO DIM	1 led module 12 W - 1110 Lm - 3000 K - >85	•	-	IP20	HAMEIN018G01	285
Recessed spotlight Deluxe NO DIM	1 led module 12 W - 1110 Lm - 3000 K - >85	•	-	IP20	HAMEIN018G02	350
Recessed spotlight white or lead grey DIM TRIAC	1 led module 12 W - 1110 Lm - 3000 K - >85	•	-	IP20	HAMEIN018G05	350
Recessed spotlight Deluxe DIM TRIAC	1 led module 12 W - 1110 Lm - 3000 K - >85	•	-	IP20	HAMEIN018G06	415
Recessed spotlight white or lead grey DIM DALI	1 led module 12 W - 1110 Lm - 3000 K - >85	•	-	IP20	HAMEIN018G03	425
Recessed spotlight Deluxe DIM DALI	1 led module 12 W - 1110 Lm - 3000 K - >85	•	-	IP20	HAMEIN018G04	495

PRODUCTS: Hoop
DESIGN: design: Modoluce R&D 2025

Large pendant and ceiling lamp. Opal plex finishing underneath.
 Upper perimetral ring in white, graphite and bronze painted metal. Lampshade in cotton or Kvadrat fabric.
 On demand, lampshade available in velvet and wool fabrics (with surcharge).

Symbol Index  → • / present - / absent OD / On Demand

HOOP

DESCRIZIONE

SORGENTE



IP

CODICE

Pendant lamp Ø 66

Metal structure painted in white, graphite or bronze

• OD IP20 IDEEDD066G01 395



Cotton 3xE27max watt 70 W HES • OD IP20 HOOESP066C01 860

Pendant lamp Kvadrat 3xE27max watt 70 W HES • OD IP20 HOOESP066I01 990

Pendant lamp cotton NO DIM 1 led module 23 W - 3628 Lm - 2700 K • OD IP20 HOOESP066C02 990

Pendant lamp cotton DIM TRIAC 1 led module 23 W - 3628 Lm - 2700 K • OD IP20 HOOESP066C03 1.070

Pendant lamp cotton DIM DALI-Push DIM 1 led module 23 W - 3628 Lm - 2700 K • OD IP20 HOOESP066C04 1.070

Pendant lamp Kvadrat NO DIM 1 led module 23 W - 3628 Lm - 2700 K • OD IP20 HOOESP066I02 1.125

Pendant lamp Kvadrat DIM TRIAC 1 led module 23 W - 3628 Lm - 2700 K • OD IP20 HOOESP066I03 1.200

Pendant lamp Kvadrat DIM DALI-Push DIM 1 led module 23 W - 3628 Lm - 2700 K • OD IP20 HOOESP066I04 1.200

Pendant lamp cotton NO DIM 1 led module 57 W - 8750 Lm - 2700 K • OD IP20 HOOESP066C05 1.155

Pendant lamp cotton DIM TRIAC 1 led module 57 W - 8750 Lm - 2700 K • OD IP20 HOOESP066C06 1.235

Pendant lamp cotton DIM DALI-Push DIM 1 led module 57 W - 8750 Lm - 2700 K • OD IP20 HOOESP066C07 1.335

Pendant lamp Kvadrat NO DIM 1 led module 57 W - 8750 Lm - 2700 K • OD IP20 HOOESP066I05 1.285

Pendant lamp Kvadrat DIM TRIAC 1 led module 57 W - 8750 Lm - 2700 K • OD IP20 HOOESP066I06 1.365

Pendant lamp Kvadrat DIM DALI-Push DIM 1 led module 57 W - 8750 Lm - 2700 K • OD IP20 HOOESP066I07 1.430

PRODUCTS: Hoop

DESIGN: design: Modoluce R&D 2025

Large pendant and ceiling lamp. Opal plex finishing underneath.

Upper perimetral ring in white, graphite and bronze painted metal. Lampshade in cotton or Kvadrat fabric.



On demand, lampshade available in velvet and wool fabrics (with surcharge).

Symbol Index  → • / present - / absent OD / On Demand

HOOP

Pendant lamp Ø 80



DESCRIZIONE	SORGENTE			IP	CODICE	
Metal structure painted in white, graphite or bronze		•	OD	IP20	IDEEDD080G01	435
Cotton	4xE27max watt 70 W HES	•	OD	IP20	HOOESP080C01	1.010
Pendant lamp Kvadrat	4xE27max watt 70 W HES	•	OD	IP20	HOOESP080I01	1.210
Pendant lamp cotton NO DIM	1 led module 23 W - 3628 Lm - 2700 K	•	OD	IP20	HOOESP080C02	1.115
Pendant lamp cotton DIM TRIAC	1 led module 23 W - 3628 Lm - 2700 K	•	OD	IP20	HOOESP080C03	1.190
Pendant lamp cotton DIM DALI-Push DIM	1 led module 23 W - 3628 Lm - 2700 K	•	OD	IP20	HOOESP080C04	1.190
Pendant lamp Kvadrat NO DIM	1 led module 23 W - 3628 Lm - 2700 K	•	OD	IP20	HOOESP080I02	1.315
Pendant lamp Kvadrat DIM TRIAC	1 led module 23 W - 3628 Lm - 2700 K	•	OD	IP20	HOOESP080I03	1.385
Pendant lamp Kvadrat DIM DALI-Push DIM	1 led module 23 W - 3628 Lm - 2700 K	•	OD	IP20	HOOESP080I04	1.385
Pendant lamp cotton NO DIM	1 led module 57 W - 8750 Lm - 2700 K	•	OD	IP20	HOOESP080C05	1.270
Pendant lamp cotton DIM TRIAC	1 led module 57 W - 8750 Lm - 2700 K	•	OD	IP20	HOOESP080C06	1.350
Pendant lamp cotton DIM DALI-Push DIM	1 led module 57 W - 8750 Lm - 2700 K	•	OD	IP20	HOOESP080C07	1.450
Pendant lamp Kvadrat NO DIM	1 led module 57 W - 8750 Lm - 2700 K	•	OD	IP20	HOOESP080I05	1.470
Pendant lamp Kvadrat DIM TRIAC	1 led module 57 W - 8750 Lm - 2700 K	•	OD	IP20	HOOESP080I06	1.545
Pendant lamp Kvadrat DIM DALI-Push DIM	1 led module 57 W - 8750 Lm - 2700 K	•	OD	IP20	HOOESP080I07	1.645

PRODUCTS: Hoop**DESIGN:** design: Modoluce R&D 2025

Large pendant and ceiling lamp. Opal plex finishing underneath.

Upper perimetral ring in white, graphite and bronze painted metal. Lampshade in cotton or Kvadrat fabric.

On demand, lampshade available in velvet and wool fabrics (with surcharge).

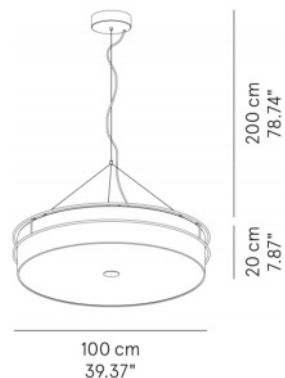
Symbol Index  → • / present - / absent OD / On Demand**HOOP****Pendant lamp Ø 100****DESCRIZIONE****SORGENTE****IP****CODICE**

Metal structure painted in white, graphite or bronze

• OD IP20 IDEEDD100G01 510

Cotton

4xE27max watt 70 W HES

• OD IP20 HOOESP100C01 1.390

Pendant lamp Kvadrat

4xE27max watt 70 W HES

• OD IP20 HOOESP100I01 1.645

Pendant lamp cotton NO DIM

1 led module 23 W - 3628 Lm - 2700 K

• OD IP20 HOOESP100C02 1.560

Pendant lamp cotton DIM TRIAC

1 led module 23 W - 3628 Lm - 2700 K

• OD IP20 HOOESP100C03 1.640

Pendant lamp cotton DIM DALI-Push DIM

1 led module 23 W - 3628 Lm - 2700 K

• OD IP20 HOOESP100C04 1.640

Pendant lamp Kvadrat NO DIM

1 led module 23 W - 3628 Lm - 2700 K

• OD IP20 HOOESP100I02 1.810

Pendant lamp Kvadrat DIM TRIAC

1 led module 23 W - 3628 Lm - 2700 K

• OD IP20 HOOESP100I03 1.890

Pendant lamp Kvadrat DIM DALI-Push DIM

1 led module 23 W - 3628 Lm - 2700 K

• OD IP20 HOOESP100I04 1.890

Pendant lamp cotton NO DIM

1 led module 57 W - 8750 Lm - 2700 K

• OD IP20 HOOESP100C05 1.725

Pendant lamp cotton DIM TRIAC

1 led module 57 W - 8750 Lm - 2700 K

• OD IP20 HOOESP100C06 1.800

Pendant lamp cotton DIM DALI-Push DIM

1 led module 57 W - 8750 Lm - 2700 K

• OD IP20 HOOESP100C07 1.830

Pendant lamp Kvadrat NO DIM

1 led module 57 W - 8750 Lm - 2700 K

• OD IP20 HOOESP100I05 1.975

Pendant lamp Kvadrat DIM TRIAC

1 led module 57 W - 8750 Lm - 2700 K

• OD IP20 HOOESP100I06 2.055

Pendant lamp Kvadrat DIM DALI-Push DIM

1 led module 57 W - 8750 Lm - 2700 K



• OD IP20 HOOESP100I07 2.085

PRODUCTS: Hoop**DESIGN:** design: Modoluce R&D 2025

Large pendant and ceiling lamp. Opal plex finishing underneath.

Upper perimetral ring in white, graphite and bronze painted metal. Lampshade in cotton or Kvadrat fabric.

On demand, lampshade available in velvet and wool fabrics (with surcharge).

Symbol Index   → • / present - / adsent OD / On Demand**HOOP****DESCRIZIONE****SORGENTE****IP****CODICE****Pendant lamp Ø 130**

Metal structure painted in white, graphite or bronze

• OD IP20 IDEED130G01 740

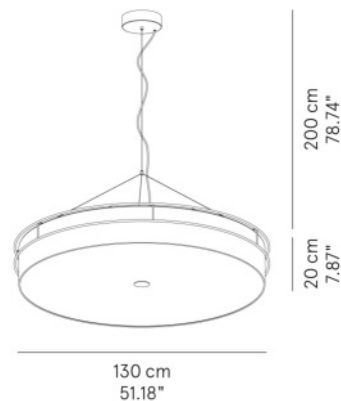

Cotton

6xE27max watt 70 W HES

• OD IP20 HOOESP130C01 2.205

Pendant lamp Kvadrat

6xE27max watt 70 W HES

• OD IP20 HOOESP130I01 2.620

Pendant lamp cotton NO DIM

1 led module 88 W - 12380 Lm - 2700 K

• OD IP20 HOOESP130C08 2.335

Pendant lamp cotton DIM DALI-Push DIM

1 led module 88 W - 12380 Lm - 2700 K

• OD IP20 HOOESP130C09 2.415

Pendant lamp Kvadrat NO DIM

1 led module 88 W - 12380 Lm - 2700 K

• OD IP20 HOOESP130I08 2.750

Pendant lamp Kvadrat DIM DALI-Push DIM

1 led module 88 W - 12380 Lm - 2700 K

• OD IP20 HOOESP130I09 2.830

ATTENTION: to calculate the price of the fixture add the structure to the pendant lamp

- 0

NOTE: on demand, LED modules are also available in 3000K and 4000K, without surcharge.

- 0

PRODUCTS: Hoop**DESIGN:** design: Modoluce R&D 2025

Large pendant and ceiling lamp. Opal plex finishing underneath.

Upper perimetral ring in white, graphite and bronze painted metal. Lampshade in cotton or Kvadrat fabric.

On demand, lampshade available in velvet and wool fabrics (with surcharge).

Symbol Index  → • / present - / absent OD / On Demand**HOOP****DESCRIZIONE****SORGENTE****IP****CODICE****Ceiling lamp Ø 66**

Metal structure painted in white, graphite or bronze

• OD IP20 IDEEDD066G01 395

20 cm
7.87"66 cm
25.98"

Ceiling lamp cotton	3xE27max watt 70 W HES	•	OD	IP20	HOOEPL066C01	950
Ceiling lamp Kvadrat	3xE27max watt 70 W HES	•	OD	IP20	HOOEPL066I01	1.080
Ceiling lamp cotton NO DIM	1 led module 23 W - 3628 Lm - 2700 K	•	OD	IP20	HOOEPL066C02	1.030
Ceiling lamp cotton DIM TRIAC	1 led module 23 W - 3628 Lm - 2700 K	•	OD	IP20	HOOEPL066C03	1.105
Ceiling lamp cotton DIM DALI-Push DIM	1 led module 23 W - 3628 Lm - 2700 K	•	OD	IP20	HOOEPL066C04	1.105
Ceiling lamp Kvadrat NO DIM	1 led module 23 W - 3628 Lm - 2700 K	•	OD	IP20	HOOEPL066I02	1.155
Ceiling lamp Kvadrat DIM TRIAC	1 led module 23 W - 3628 Lm - 2700 K	•	OD	IP20	HOOEPL066I03	1.235
Ceiling lamp Kvadrat DIM DALI-Push DIM	1 led module 23 W - 3628 Lm - 2700 K	•	OD	IP20	HOOEPL066I04	1.235
Ceiling lamp cotton NO DIM	1 led module 57 W - 8750 Lm - 2700 K	•	OD	IP20	HOOEPL066C05	1.195
Ceiling lamp cotton DIM TRIAC	1 led module 57 W - 8750 Lm - 2700 K	•	OD	IP20	HOOEPL066C06	1.270
Ceiling lamp cotton DIM DALI-Push DIM	1 led module 57 W - 8750 Lm - 2700 K	•	OD	IP20	HOOEPL066C07	1.315
Ceiling lamp Kvadrat NO DIM	1 led module 57 W - 8750 Lm - 2700 K	•	OD	IP20	HOOEPL066I05	1.330
Ceiling lamp Kvadrat DIM TRIAC	1 led module 57 W - 8750 Lm - 2700 K	•	OD	IP20	HOOEPL066I06	1.400
Ceiling lamp Kvadrat DIM DALI-Push DIM	1 led module 57 W - 8750 Lm - 2700 K	•	OD	IP20	HOOEPL066I07	1.445

PRODUCTS: Hoop**DESIGN:** design: Modoluce R&D 2025

Large pendant and ceiling lamp. Opal plex finishing underneath.

Upper perimetral ring in white, graphite and bronze painted metal. Lampshade in cotton or Kvadrat fabric.

On demand, lampshade available in velvet and wool fabrics (with surcharge).

Symbol Index  → • / present - / absent OD / On Demand**HOOP****Ceiling lamp Ø 80**80 cm
31.50"20 cm
7.87"**DESCRIZIONE****SORGENTE****IP****CODICE**

Metal structure painted in white, graphite or bronze

Ceiling lamp cotton

4xE27max watt 70 W HES



OD

IP20

IDEEEDD080G01

435

Ceiling lamp Kvadrat

4xE27max watt 70 W HES



OD

IP20

HOOEPL080I01

1.375

Ceiling lamp cotton NO DIM

1 led module 23 W - 3628 Lm - 2700 K



OD

IP20

HOOEPL080C02

1.135

Ceiling lamp cotton DIM TRIAC

1 led module 23 W - 3628 Lm - 2700 K



OD

IP20

HOOEPL080C03

1.215

Ceiling lamp cotton DIM DALI-Push DIM

1 led module 23 W - 3628 Lm - 2700 K



OD

IP20

HOOEPL080C04

1.215

Ceiling lamp Kvadrat NO DIM

1 led module 23 W - 3628 Lm - 2700 K



OD

IP20

HOOEPL080I02

1.335

Ceiling lamp Kvadrat DIM TRIAC

1 led module 23 W - 3628 Lm - 2700 K



OD

IP20

HOOEPL080I03

1.405

Ceiling lamp Kvadrat DIM DALI-Push DIM

1 led module 23 W - 3628 Lm - 2700 K



OD

IP20

HOOEPL080I04

1.405

Ceiling lamp cotton NO DIM

1 led module 57 W - 8750 Lm - 2700 K



OD

IP20

HOOEPL080C05

1.305

Ceiling lamp cotton DIM TRIAC

1 led module 57 W - 8750 Lm - 2700 K



OD

IP20

HOOEPL080C06

1.380

Ceiling lamp cotton DIM DALI-Push DIM

1 led module 57 W - 8750 Lm - 2700 K



OD

IP20

HOOEPL080C07

1.420

Ceiling lamp Kvadrat NO DIM

1 led module 57 W - 8750 Lm - 2700 K



OD

IP20

HOOEPL080I05

1.500

Ceiling lamp Kvadrat DIM TRIAC

1 led module 57 W - 8750 Lm - 2700 K



OD

IP20

HOOEPL080I06

1.580

Ceiling lamp Kvadrat DIM DALI-Push DIM

1 led module 57 W - 8750 Lm - 2700 K



OD

IP20

HOOEPL080I07

1.615

PRODUCTS: Hoop**DESIGN:** design: Modoluce R&D 2025

Large pendant and ceiling lamp. Opal plex finishing underneath.

Upper perimetral ring in white, graphite and bronze painted metal. Lampshade in cotton or Kvadrat fabric.

On demand, lampshade available in velvet and wool fabrics (with surcharge).

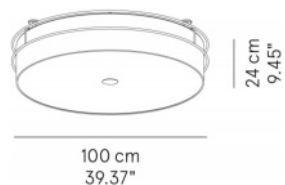
Symbol Index  → • / present - / absent OD / On Demand**HOOP****Ceiling lamp Ø 100****DESCRIZIONE****SORGENTE****IP****CODICE**

Metal structure painted in white, graphite or bronze

Ceiling lamp cotton

4xE27max watt 70 W HES

• OD IP20 IDEEDD100G01 510

Ceiling lamp Kvadrat

4xE27max watt 70 W HES

• OD IP20 HOOEPL100C01 1.555
• OD IP20 HOOEPL100I01 1.805

Ceiling lamp cotton NO DIM

1 led module 23 W - 3628 Lm - 2700 K

• OD IP20 HOOEPL100C02 1.515

Ceiling lamp cotton DIM TRIAC

1 led module 23 W - 3628 Lm - 2700 K

• OD IP20 HOOEPL100C03 1.595

Ceiling lamp cotton DIM DALI-Push DIM

1 led module 23 W - 3628 Lm - 2700 K

• OD IP20 HOOEPL100C04 1.595

Ceiling lamp Kvadrat NO DIM

1 led module 23 W - 3628 Lm - 2700 K

• OD IP20 HOOEPL100I02 1.770

Ceiling lamp Kvadrat DIM TRIAC

1 led module 23 W - 3628 Lm - 2700 K

• OD IP20 HOOEPL100I03 1.850

Ceiling lamp Kvadrat DIM DALI-Push DIM

1 led module 23 W - 3628 Lm - 2700 K

• OD IP20 HOOEPL100I04 1.850

Ceiling lamp cotton NO DIM

1 led module 57 W - 8750 Lm - 2700 K

• OD IP20 HOOEPL100C05 1.685

Ceiling lamp cotton DIM TRIAC

1 led module 57 W - 8750 Lm - 2700 K

• OD IP20 HOOEPL100C06 1.765

Ceiling lamp cotton DIM DALI-Push DIM

1 led module 57 W - 8750 Lm - 2700 K

• OD IP20 HOOEPL100C07 1.800

Ceiling lamp Kvadrat NO DIM

1 led module 57 W - 8750 Lm - 2700 K

• OD IP20 HOOEPL100I05 1.935

Ceiling lamp Kvadrat DIM TRIAC

1 led module 57 W - 8750 Lm - 2700 K

• OD IP20 HOOEPL100I06 2.015

Ceiling lamp Kvadrat DIM DALI-Push DIM

1 led module 57 W - 8750 Lm - 2700 K



• OD IP20 HOOEPL100I07 2.055

PRODUCTS: Hoop**DESIGN:** design: Modoluce R&D 2025

Large pendant and ceiling lamp. Opal plex finishing underneath.

Upper perimetral ring in white, graphite and bronze painted metal. Lampshade in cotton or Kvadrat fabric.

On demand, lampshade available in velvet and wool fabrics (with surcharge).

Symbol Index   → • / present - / adsent OD / On Demand**HOOP****DESCRIZIONE****SORGENTE****IP****CODICE****Ceiling lamp Ø 130**

Metal structure painted in white, graphite or bronze

• OD IP20 IDEED130G01 740

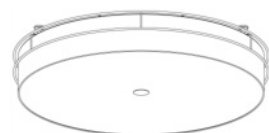
24 cm
9.45"130 cm
51.18"

Ceiling lamp cotton

6xE27max watt 70 W HES

• OD IP20 HOOEPL130C01 2.435

Ceiling lamp Kvadrat

6xE27max watt 70 W HES

• OD IP20 HOOEPL130I01 2.850

Ceiling lamp cotton NO DIM

1 led module 88 W - 12380 Lm - 2700 K

• OD IP20 HOOEPL130C08 2.500

Ceiling lamp cotton DIM DALI-Push DIM

1 led module 88 W - 12380 Lm - 2700 K

• OD IP20 HOOEPL130C09 2.640

Ceiling lamp Kvadrat NO DIM

1 led module 88 W - 12380 Lm - 2700 K

• OD IP20 HOOEPL130I08 2.915

Ceiling lamp Kvadrat DIM DALI-Push DIM

1 led module 88 W - 12380 Lm - 2700 K

• OD IP20 HOOEPL130I09 3.055

ATTENTION: to calculate the price of the fixture add the structure to the ceiling lamp

- 0

NOTE: on demand, LED modules are also available in 3000K and 4000K, without surcharge.

- 0

PRODUCTS: Icaro

DESIGN: design: Brian Rasmussen 2011

Pendant lamp with structure in painted steel wire white, black or bronze matt.

Light bulb at sight or covered by a removable cotton fabric stripe (see accessory in the price list).

Symbol Index  → • / present - / adsent OD / On Demand

ICARO

DESCRIZIONE

SORGENTE



IP

CODICE

Pendant lamp - ø 50

Pendant lamp

1xE27max watt 42 W HES

• OD IP20 ICIESO050G01 900

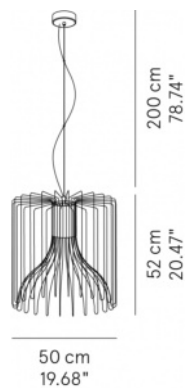

Coloured stripe in cotton fabric ø 50/60/75

OD ICIEFS050C01 30

Pendant lamp - ø 75

Pendant lamp

1xE27max watt 42 W HES

• OD IP20 ICIESO075G01 1.225



Coloured stripe in cotton fabric ø 50/60/75

OD ICIEFS050C01 30

PRODUCTS: Icaro

DESIGN: design: Brian Rasmussen 2011

Pendant lamp with structure in painted steel wire white, black or bronze matt.

Light bulb at sight or covered by a removable cotton fabric stripe (see accessory in the price list).

Symbol Index  → • / present - / adsent OD / On Demand

ICARO

DESCRIZIONE

SORGENTE



IP

CODICE

Pendant lamp - ø 100

Pendant lamp

1xE27max watt 70 W HES

• OD IP20 ICIESO100G01 1.850

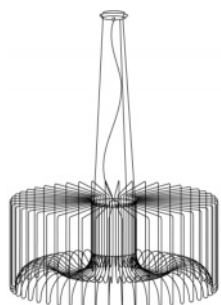

100 cm
39.37"

Coloured stripe in cotton fabric ø 100

OD ICIEFS100C01 55

PRODUCTS: Icaro Outdoor



DESIGN: design: Brian Rasmussen 2011

Pendant lamp with structure in painted steel wire white, black or bronze matt.

Light bulb protected by an IP44 glass diffuser.

On demand, cover in removable washable fabric stripe available (see accessory in the price list).

Metal parts are protected with anticorrosive primer and resistant polyester coating.

Symbol Index   → • / present - / absent OD / On Demand

ICARO OUTDOOR

DESCRIZIONE	SORGENTE	  IP	CODICE
Pendant lamp - ø 50	Pendant lamp	1xE27max watt 42 W HES	• - IP44/64 ICOESO050G01 1.030

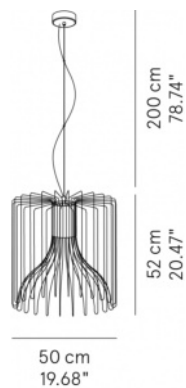

Coloured stripe in washable ø 50/60/75

OD ICIEFS050T01 35

Pendant lamp - ø 75	Pendant lamp	1xE27max watt 42 W HES	• - IP44/64 ICOESO075G01 1.405
---------------------	--------------	------------------------	--------------------------------



Coloured stripe in washable ø 50/60/75

OD ICIEFS050T01 35

PRODUCTS: Icaro Outdoor

DESIGN: design: Brian Rasmussen 2011

Pendant lamp with structure in painted steel wire white, black or bronze matt.

Light bulb protected by an IP44 glass diffuser.

On demand, cover in removable washable fabric stripe available (see accessory in the price list).

Metal parts are protected with anticorrosive primer and resistant polyester coating.

Symbol Index  → • / present - / absent OD / On Demand

ICARO OUTDOOR

DESCRIZIONE

SORGENTE



IP

CODICE

Pendant lamp - ø 100

Pendant lamp

1xE27max watt 70 W HES

• - IP44/64 ICOESO100G01 2.055

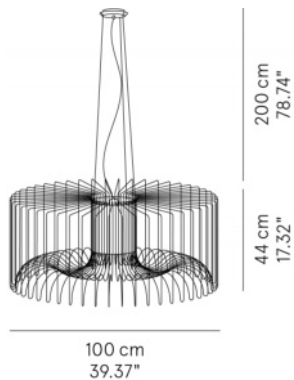

Coloured stripe in washable ø 100

OD ICIEFS100T01 75

PRODUCTS: Icaro Ball

DESIGN: design: Brian Rasmussen 2012

Pendant lamp with structure in painted steel wire white, black or bronze matt.

Light bulb at sight or covered by a removable cotton fabric stripe (see accessory in the price list).

Symbol Index  → • / present - / adsent OD / On Demand

ICARO BALL

DESCRIZIONE

SORGENTE



IP

CODICE

Pendant lamp - ø 50

Pendant lamp

1xE27max watt 42 W HES

• OD IP20 IBIESO050G01 930

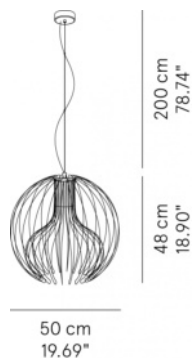

Coloured stripe in cotton fabric ø 50/60/75

OD ICIEFS050C01 30

Pendant lamp - ø 60

Pendant lamp

1xE27max watt 42 W HES

• OD IP20 IBIESO060G01 1.245



Coloured stripe in cotton fabric ø 50/60/75



OD ICIEFS050C01 30

PRODUCTS: Icaro Ball

DESIGN: design: Brian Rasmussen 2012

Pendant lamp with structure in painted steel wire white, black or bronze matt.

Light bulb at sight or covered by a removable cotton fabric stripe (see accessory in the price list).

Symbol Index   → • / present - / adsent OD / On Demand

ICARO BALL

DESCRIZIONE

SORGENTE



IP

CODICE

Pendant lamp - ø 75

Pendant lamp

1xE27max watt 42 W HES

• OD IP20 IBIESO075G01 1.385

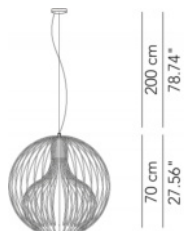

75 cm
29.53"

Coloured stripe in cotton fabric ø 50/60/75

OD ICIEFS050C01 30

Pendant lamp - ø 90

Pendant lamp

1xE27max watt 70 W HES

• OD IP20 IBIESO090G01 1.930



90 cm
35.43"

Coloured stripe in cotton fabric ø 90

OD ICIEFS090C01 55

PRODUCTS: Icaro Ball Outdoor

DESIGN: design: Brian Rasmussen 2012

Pendant lamp with structure in painted steel wire white, black or bronze matt.

Light bulb protected by an IP44 glass diffuser.

On demand, cover in removable washable fabric stripe available (see accessory in the price list).

Metal parts are protected with anticorrosive primer and resistant polyester coating.

Symbol Index  → • / present - / absent OD / On Demand

ICARO BALL OUTDOOR DESCRIZIONE

SORGENTE

  **IP** CODICE

Pendant lamp - ø 50

Pendant lamp

1xE27max watt 42 W HES

• - IP44/64 IBOESO050G01 1.040

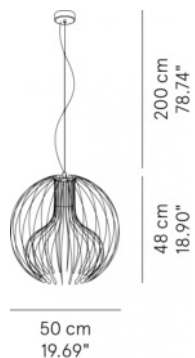

Coloured stripe in washable ø 50/60/75

OD ICIEFS050T01 35

Pendant lamp - ø 60

Pendant lamp

1xE27max watt 42 W HES

• - IP44/64 IBOESO060G01 1.365



Coloured stripe in washable ø 50/60/75

OD ICIEFS050T01 35

PRODUCTS: Icaro Ball Outdoor



DESIGN: design: Brian Rasmussen 2012

Pendant lamp with structure in painted steel wire white, black or bronze matt.

Light bulb protected by an IP44 glass diffuser.

On demand, cover in removable washable fabric stripe available (see accessory in the price list).

Metal parts are protected with anticorrosive primer and resistant polyester coating.

Symbol Index   → • / present - / absent OD / On Demand

ICARO BALL OUTDOOR DESCRIZIONE

SORGENTE



IP

CODICE

Pendant lamp - ø 75

Pendant lamp

1xE27max watt 42 W HES

• - IP44/64 IBOESO075G01 1.530

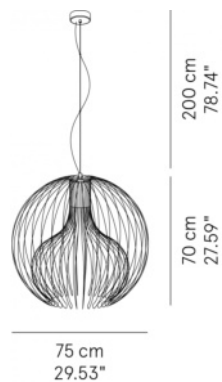

Coloured stripe in washable ø 50/60/75

OD ICIEFS050T01 35

Pendant lamp - ø 90

Pendant lamp

1xE27max watt 70 W HES

• - IP44/64 IBOESO090G01 1.965

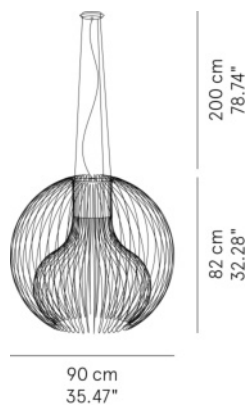

Coloured stripe in washable ø 90

OD ICIEFS090T01 75

PRODUCTS: Idea
DESIGN: design: Paolo Grasselli 2019

Pendant and wall/ ceiling lamp.
 Metal structure painted in white, graphite or bronze. Inner disc upholstered with velvet, wool and Kvadrat fabric.
 Lamp with acoustic comfort features.

Symbol Index  → • / present - / absent OD / On Demand

IDEA	DESCRIZIONE	SORGENTE			IP	CODICE	
Pendant lamp Ø 66	Metal structure painted in white, graphite or bronze		•	OD	IP20	IDEEDD066G01	395

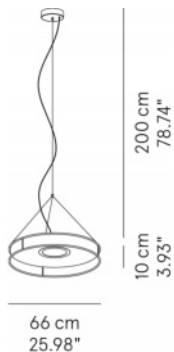

Pendant lamp velvet NO DIM	1 led module 18 W - 1660 Lm - 2800 K - >80	•	OD	IP20	IDEESO060O02	1.170
Wool NO DIM	1 led module 18 W - 1660 Lm - 2800 K - >80	•	OD	IP20	IDEESO060E02	1.170
Pendant lamp Kvadrat NO DIM	1 led module 18 W - 1660 Lm - 2800 K - >80	•	OD	IP20	IDEESO060I02	1.270
Pendant lamp velvet DIM DALI-Push DIM	1 led module 18 W - 1660 Lm - 2800 K - >80	•	OD	IP20	IDEESO060O03	1.420
Wool DIM DALI-Push DIM	1 led module 18 W - 1660 Lm - 2800 K - >80	•	OD	IP20	IDEESO060E03	1.420
Pendant lamp Kvadrat DIM DALI-Push DIM	1 led module 18 W - 1660 Lm - 2800 K - >80	•	OD	IP20	IDEESO060I03	1.525

Pendant lamp Ø 80	Metal structure painted in white, graphite or bronze		•	OD	IP20	IDEEDD080G01	435
--------------------------	--	--	---	----	------	--------------	-----

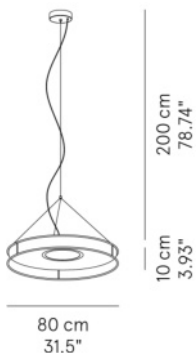

Pendant lamp velvet NO DIM	1 led module 24 W - 2150 Lm - 3000 K - >85	•	OD	IP20	IDEESO080O02	1.365
Wool NO DIM	1 led module 24 W - 2150 Lm - 3000 K - >85	•	OD	IP20	IDEESO080E02	1.365
Pendant lamp Kvadrat NO DIM	1 led module 24 W - 2150 Lm - 3000 K - >85	•	OD	IP20	IDEESO080I02	1.495
Pendant lamp velvet DIM DALI-Push DIM	1 led module 24 W - 2150 Lm - 3000 K - >85	•	OD	IP20	IDEESO080O03	1.615
Wool DIM DALI-Push DIM	1 led module 24 W - 2150 Lm - 3000 K - >85	•	OD	IP20	IDEESO080E03	1.615
Pendant lamp Kvadrat DIM DALI-Push DIM	1 led module 24 W - 2150 Lm - 3000 K - >85	•	OD	IP20	IDEESO080I03	1.750

PRODUCTS: Idea
DESIGN: design: Paolo Grasselli 2019

Pendant and wall/ ceiling lamp.
 Metal structure painted in white, graphite or bronze. Inner disc upholstered with velvet, wool and Kvadrat fabric.
 Lamp with acoustic comfort features.

Symbol Index  → • / present - / adsent OD / On Demand

IDEA	DESCRIZIONE	SORGENTE	 	IP	CODICE	
Pendant lamp Ø 100	Metal structure painted in white, graphite or bronze		•	OD IP20	IDEEDD100G01	510

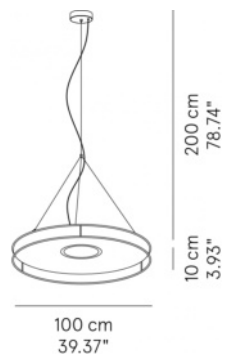

Pendant lamp velvet NO DIM	1 led module 24 W - 2150 Lm - 3000 K - >85	•	OD IP20	IDEESO100O02	1.640
Wool NO DIM	1 led module 24 W - 2150 Lm - 3000 K - >85	•	OD IP20	IDEESO100E02	1.640
Pendant lamp Kvadrat NO DIM	1 led module 24 W - 2150 Lm - 3000 K - >85	•	OD IP20	IDEESO100I02	1.795
Pendant lamp velvet DIM DALI-Push DIM	1 led module 24 W - 2150 Lm - 3000 K - >85	•	OD IP20	IDEESO100O03	1.890
Wool DIM DALI-Push DIM	1 led module 24 W - 2150 Lm - 3000 K - >85	•	OD IP20	IDEESO100E03	1.890
Pendant lamp Kvadrat DIM DALI-Push DIM	1 led module 24 W - 2150 Lm - 3000 K - >85	•	OD IP20	IDEESO100I03	2.050

Pendant lamp Ø 130	Metal structure painted in white, graphite or bronze		•	OD IP20	IDEEDD130G01	740
---------------------------	--	--	---	---------	--------------	-----

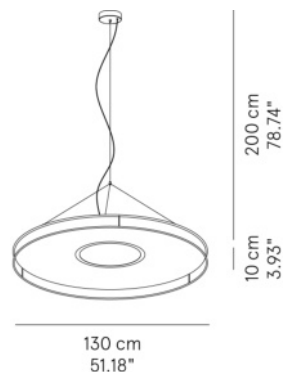

Pendant lamp velvet NO DIM	1 led module 24 W - 2150 Lm - 3000 K - >85	•	OD IP20	IDEESO130O02	1.995
Wool NO DIM	1 led module 24 W - 2150 Lm - 3000 K - >85	•	OD IP20	IDEESO130E02	1.995
Pendant lamp Kvadrat NO DIM	1 led module 24 W - 2150 Lm - 3000 K - >85	•	OD IP20	IDEESO130I02	2.190
Pendant lamp velvet DIM DALI-Push DIM	1 led module 24 W - 2150 Lm - 3000 K - >85	•	OD IP20	IDEESO130O03	2.245
Wool DIM DALI-Push DIM	1 led module 24 W - 2150 Lm - 3000 K - >85	•	OD IP20	IDEESO130E03	2.245
Pendant lamp Kvadrat DIM DALI-Push DIM	1 led module 24 W - 2150 Lm - 3000 K - >85	•	OD IP20	IDEESO130I03	2.445







ATTENTION: to calculate the price of the fixture add the structure to the pendant lamp

- 0

PRODUCTS: Idea
DESIGN: design: Paolo Grasselli 2019

Pendant and wall/ ceiling lamp.
 Metal structure painted in white, graphite or bronze. Inner disc upholstered with velvet, wool and Kvadrat fabric.
 Lamp with acoustic comfort features.

Symbol Index  → • / present - / absent OD / On Demand

IDEA	DESCRIZIONE	SORGENTE			IP	CODICE	
Ceiling/Wall lamp Ø 66	Metal structure painted in white, graphite or bronze		•	OD	IP20	IDEEDD066G01	395
	Wall/ ceiling lamp velvet NO DIM	1 led module 18 W - 1660 Lm - 2800 K - >80	•	OD	IP20	IDEEPL060O02	1.235
66 cm 25.98"	Wall/ ceiling lamp wool NO DIM	1 led module 18 W - 1660 Lm - 2800 K - >80	•	OD	IP20	IDEEPL060E02	1.235
13 cm 5.11"	Wall/ ceiling lamp Kvadrat NO DIM	1 led module 18 W - 1660 Lm - 2800 K - >80	•	OD	IP20	IDEEPL060I02	1.340
	Wall/ ceiling lamp velvet DIM DALI-Push DIM	1 led module 18 W - 1660 Lm - 2800 K - >80	•	OD	IP20	IDEEPL060O03	1.455
66 cm 25.98"	Wall/ ceiling lamp wool DIM DALI-Push DIM	1 led module 18 W - 1660 Lm - 2800 K - >80	•	OD	IP20	IDEEPL060E03	1.455
13 cm 5.11"	Wall/ ceiling lamp Kvadrat DIM DALI-Push DIM	1 led module 18 W - 1660 Lm - 2800 K - >80	•	OD	IP20	IDEEPL060I03	1.555
Ceiling/Wall lamp Ø 80	Metal structure painted in white, graphite or bronze		•	OD	IP20	IDEEDD080G01	435
	Wall/ ceiling lamp velvet NO DIM	1 led module 24 W - 2150 Lm - 3000 K - >85	•	OD	IP20	IDEEPL080O02	1.430
80 cm 31.5"	Wall/ ceiling lamp wool NO DIM	1 led module 24 W - 2150 Lm - 3000 K - >85	•	OD	IP20	IDEEPL080E02	1.430
13 cm 5.11"	Wall/ ceiling lamp Kvadrat NO DIM	1 led module 24 W - 2150 Lm - 3000 K - >85	•	OD	IP20	IDEEPL080I02	1.560
	Wall/ ceiling lamp velvet DIM DALI-Push DIM	1 led module 24 W - 2150 Lm - 3000 K - >85	•	OD	IP20	IDEEPL080O03	1.650
80 cm 31.5"	Wall/ ceiling lamp wool DIM DALI-Push DIM	1 led module 24 W - 2150 Lm - 3000 K - >85	•	OD	IP20	IDEEPL080E03	1.650
13 cm 5.11"	Wall/ ceiling lamp Kvadrat DIM DALI-Push DIM	1 led module 24 W - 2150 Lm - 3000 K - >85	•	OD	IP20	IDEEPL080I03	1.780

PRODUCTS: Idea
DESIGN: design: Paolo Grasselli 2019

Pendant and wall/ ceiling lamp.
 Metal structure painted in white, graphite or bronze. Inner disc upholstered with velvet, wool and Kvadrat fabric.
 Lamp with acoustic comfort features.

Symbol Index  → • / present - / adsent OD / On Demand

IDEA	DESCRIZIONE	SORGENTE	  IP	CODICE	
Ceiling/Wall lamp Ø 100	Metal structure painted in white, graphite or bronze		• OD IP20	IDEEDD100G01	510

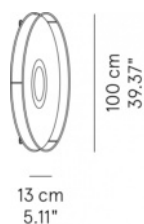
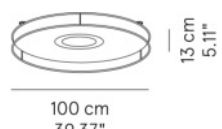

Wall/ ceiling lamp velvet NO DIM	1 led module 24 W - 2150 Lm - 3000 K - >85	• OD IP20	IDEEPL100O02	1.695
Wall/ ceiling lamp wool NO DIM	1 led module 24 W - 2150 Lm - 3000 K - >85	• OD IP20	IDEEPL100E02	1.695
Wall/ ceiling lamp Kvadrat NO DIM	1 led module 24 W - 2150 Lm - 3000 K - >85	• OD IP20	IDEEPL100I02	1.860
Wall/ ceiling lamp velvet DIM DALI-Push DIM	1 led module 24 W - 2150 Lm - 3000 K - >85	• OD IP20	IDEEPL100O03	1.915
Wall/ ceiling lamp wool DIM DALI-Push DIM	1 led module 24 W - 2150 Lm - 3000 K - >85	• OD IP20	IDEEPL100E03	1.915
Wall/ ceiling lamp Kvadrat DIM DALI-Push DIM	1 led module 24 W - 2150 Lm - 3000 K - >85	• OD IP20	IDEEPL100I03	2.075

Ceiling/Wall lamp Ø 130	Metal structure painted in white, graphite or bronze		• OD IP20	IDEEDD130G01	740
--------------------------------	--	--	-----------	--------------	-----

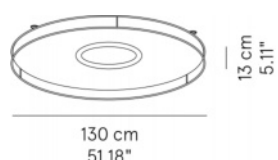

Wall/ ceiling lamp velvet NO DIM	1 led module 24 W - 2150 Lm - 3000 K - >85	• OD IP20	IDEEPL130O02	2.055
Wall/ ceiling lamp wool NO DIM	1 led module 24 W - 2150 Lm - 3000 K - >85	• OD IP20	IDEEPL130E02	2.055
Wall/ ceiling lamp Kvadrat NO DIM	1 led module 24 W - 2150 Lm - 3000 K - >85	• OD IP20	IDEEPL130I02	2.245
Wall/ ceiling lamp velvet DIM DALI-Push DIM	1 led module 24 W - 2150 Lm - 3000 K - >85	• OD IP20	IDEEPL130O03	2.275
Wall/ ceiling lamp wool DIM DALI-Push DIM	1 led module 24 W - 2150 Lm - 3000 K - >85	• OD IP20	IDEEPL130E03	2.275
Wall/ ceiling lamp Kvadrat DIM DALI-Push DIM	1 led module 24 W - 2150 Lm - 3000 K - >85	• OD IP20	IDEEPL130I03	2.470



PRODUCTS: Idea



DESIGN: design: Paolo Grasselli 2019

Pendant and wall/ ceiling lamp.

Metal structure painted in white, graphite or bronze. Inner disc upholstered with velvet, wool and Kvadrat fabric.

Lamp with acoustic comfort features.

Symbol Index   → • / present - / adsent OD / On Demand

IDEA	DESCRIZIONE	SORGENTE	 	IP CODICE
	ATTENTION: to calculate the price of the fixture add the structure to the ceiling lamp			- 0

Accessory - Wall/ ceiling lamp	Anti-glare lens for 18W and 24W			IDEEAC00012G 140
---------------------------------------	---------------------------------	--	--	------------------



6/10 cm
2.3/3.9"

PRODUCTS: Loto

DESIGN: design: Romano + Menegon 2008

Pendant and wall lamp in hand-finished pleated and pleated ribbon fabric.

Opal plex finishing underneath (d.16 excluded).

Symbol Index  → • / present - / absent OD / On Demand

LOTO

DESCRIZIONE

SORGENTE



IP

CODICE

Pendant lamp - ø 16 without plex

Pendant lamp pleated fabric

1xE14max watt 42 W HES

• OD IP20 LOTESE016P01 305

Pleated ribbon fabric

1xE14max watt 42 W HES

OD OD IP20 LOTESE016R01 320



Pendant lamp - ø 60

Pendant lamp pleated fabric

3xE27max watt 70 W HES

OD OD IP20 LOTESP060P01 1.155

Pleated ribbon fabric

3xE27max watt 70 W HES

OD OD IP20 LOTESP060R01 1.200

Pendant lamp pleated fabric NO DIM

1 led module 23 W - 3628 Lm - 2700 K

OD OD IP20 LOTESP060P08 1.335

Pendant lamp pleated fabric DIM TRIAC

1 led module 23 W - 3628 Lm - 2700 K

OD OD IP20 LOTESP060P09 1.395

Pendant lamp pleated fabric DIM DALI-Push DIM

1 led module 23 W - 3628 Lm - 2700 K

OD OD IP20 LOTESP060P10 1.395

Pendant lamp pleated ribbon fabric NO DIM

1 led module 23 W - 3628 Lm - 2700 K

OD OD IP20 LOTESP060R08 1.375

Pendant lamp pleated ribbon fabric DIM TRIAC

1 led module 23 W - 3628 Lm - 2700 K

OD OD IP20 LOTESP060R09 1.445

Pendant lamp pleated ribbon fabric DIM DALI-Push DIM

1 led module 23 W - 3628 Lm - 2700 K

OD OD IP20 LOTESP060R10 1.445



PRODUCTS: Loto

DESIGN: design: Romano + Menegon 2008

Pendant and wall lamp in hand-finished pleated and pleated ribbon fabric.

Opal plex finishing underneath (d.16 excluded).

Symbol Index  → • / present - / adsent OD / On Demand



LOTO

Pendant lamp - ø 80



200 cm
78.74"
35 cm
13.78"

80 cm
31.50"

DESCRIZIONE	SORGENTE			IP	CODICE	
Pendant lamp pleated fabric	4xE27max watt 70 W HES	OD	OD	IP20	LOTESP080P01	1.740
Pleated ribbon fabric	4xE27max watt 70 W HES	OD	OD	IP20	LOTESP080R01	1.790
Pendant lamp pleated fabric NO DIM	1 led module 23 W - 3628 Lm - 2700 K	OD	OD	IP20	LOTESP080P05	1.880
Pendant lamp pleated fabric DIM TRIAC	1 led module 23 W - 3628 Lm - 2700 K	OD	OD	IP20	LOTESP080P06	1.975
Pendant lamp pleated fabric DIM DALI-Push DIM	1 led module 23 W - 3628 Lm - 2700 K	OD	OD	IP20	LOTESP080P07	1.975
Pendant lamp pleated ribbon fabric NO DIM	1 led module 23 W - 3628 Lm - 2700 K	OD	OD	IP20	LOTESP080R05	1.930
Pendant lamp pleated ribbon fabric DIM TRIAC	1 led module 23 W - 3628 Lm - 2700 K	OD	OD	IP20	LOTESP080R06	2.030
Pendant lamp pleated ribbon fabric DIM DALI-Push DIM	1 led module 23 W - 3628 Lm - 2700 K	OD	OD	IP20	LOTESP080R07	2.030

PRODUCTS: Loto

DESIGN: design: Romano + Menegon 2008

Pendant and wall lamp in hand-finished pleated and pleated ribbon fabric.

Opal plex finishing underneath (d.16 excluded).

Symbol Index  → • / present - / adsent OD / On Demand



LOTO

Pendant lamp - ø 100



100 cm
39.3"

200 cm
78.74"
35 cm
13.78"

DESCRIZIONE	SORGENTE			IP	CODICE	
Pendant lamp pleated fabric	4xE27max watt 70 W HES	OD	OD	IP20	LOTESP100P01	2.235
Pleated ribbon fabric	4xE27max watt 70 W HES	OD	OD	IP20	LOTESP100R01	2.315
Pendant lamp pleated fabric NO DIM	1 led module 23 W - 3628 Lm - 2700 K	OD	OD	IP20	LOTESP100P08	2.345
Pendant lamp pleated fabric DIM TRIAC	1 led module 23 W - 3628 Lm - 2700 K	OD	OD	IP20	LOTESP100P09	2.425
Pendant lamp pleated fabric DIM DALI-Push DIM	1 led module 23 W - 3628 Lm - 2700 K	OD	OD	IP20	LOTESP100P10	2.425
Pendant lamp pleated ribbon fabric NO DIM	1 led module 23 W - 3628 Lm - 2700 K	OD	OD	IP20	LOTESP100R08	2.425
Pendant lamp pleated ribbon fabric DIM TRIAC	1 led module 23 W - 3628 Lm - 2700 K	OD	OD	IP20	LOTESP100R09	2.500
Pendant lamp pleated ribbon fabric DIM DALI-Push DIM	1 led module 23 W - 3628 Lm - 2700 K	OD	OD	IP20	LOTESP100R10	2.500
Pendant lamp pleated fabric NO DIM	1 led module 57 W - 8750 Lm - 2700 K	OD	OD	IP20	LOTESP100P13	2.500
Pendant lamp pleated fabric DIM TRIAC	1 led module 57 W - 8750 Lm - 2700 K	OD	OD	IP20	LOTESP100P14	2.590
Pendant lamp pleated fabric DIM DALI-Push DIM	1 led module 57 W - 8750 Lm - 2700 K	OD	OD	IP20	LOTESP100P15	2.610
Pendant lamp pleated ribbon fabric NO DIM	1 led module 57 W - 8750 Lm - 2700 K	OD	OD	IP20	LOTESP100R13	2.580
Pendant lamp pleated ribbon fabric DIM TRIAC	1 led module 57 W - 8750 Lm - 2700 K	OD	OD	IP20	LOTESP100R14	2.665
Pendant lamp pleated ribbon fabric DIM DALI-Push DIM	1 led module 57 W - 8750 Lm - 2700 K	OD	OD	IP20	LOTESP100R15	2.690

PRODUCTS: Loto

DESIGN: design: Romano + Menegon 2008

Pendant and wall lamp in hand-finished pleated and pleated ribbon fabric.

Opal plex finishing underneath (d.16 excluded).

Symbol Index  → • / present - / adsent OD / On Demand

LOTO

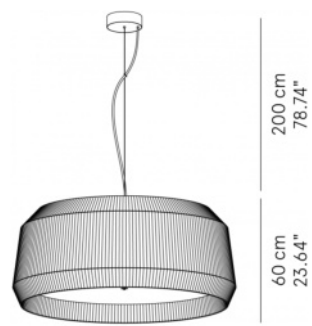

Pendant lamp - ø 140



140 cm
55.12"

200 cm
78.74"

60 cm
23.64"

DESCRIZIONE	SORGENTE			IP	CODICE	
Pendant lamp pleated fabric	6xE27max watt 105 W HES	OD	OD	IP20	LOTESP140P01	4.590
Pleated ribbon fabric	6xE27max watt 105 W HES	OD	OD	IP20	LOTESP140R01	4.745
Pendant lamp pleated fabric NO DIM	1 led module 88 W - 12380 Lm - 2700 K	OD	OD	IP20	LOTESP140P08	4.860
Pendant lamp pleated fabric DIM DALI-Push DIM	1 led module 88 W - 12380 Lm - 2700 K	OD	OD	IP20	LOTESP140P09	4.955
Pendant lamp pleated ribbon fabric NO DIM	1 led module 88 W - 12380 Lm - 2700 K	OD	OD	IP20	LOTESP140R08	5.020
Pendant lamp pleated ribbon fabric DIM DALI-Push DIM	1 led module 88 W - 12380 Lm - 2700 K	OD	OD	IP20	LOTESP140R09	5.115

Pendant lamp - ø 140 x 115

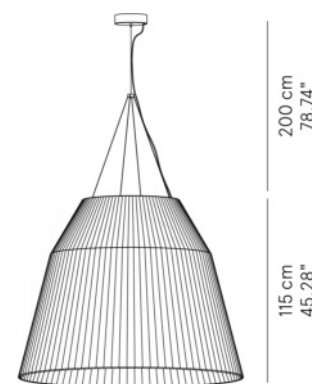

140 cm
55.12"

200 cm
78.74"

115 cm
45.28"



Pendant lamp pleated fabric NO DIM	1 led module 57 W - 8750 Lm - 2700 K	OD	OD	IP20	LOTESP115P02	6.715
Pendant lamp pleated fabric DIM TRIAC	1 led module 57 W - 8750 Lm - 2700 K	OD	OD	IP20	LOTESP115P03	6.785
Pendant lamp pleated fabric DIM DALI-Push DIM	1 led module 57 W - 8750 Lm - 2700 K	OD	OD	IP20	LOTESP115P04	6.785
Pendant lamp pleated ribbon fabric NO DIM	1 led module 57 W - 8750 Lm - 2700 K	OD	OD	IP20	LOTESP115R02	6.715
Pendant lamp pleated ribbon fabric DIM TRIAC	1 led module 57 W - 8750 Lm - 2700 K	OD	OD	IP20	LOTESP115R03	6.785
Pendant lamp pleated ribbon fabric DIM DALI-Push DIM	1 led module 57 W - 8750 Lm - 2700 K	OD	OD	IP20	LOTESP115R04	6.785

PRODUCTS: Loto

DESIGN: design: Romano + Menegon 2008

Pendant and wall lamp in hand-finished pleated and pleated ribbon fabric.

Opal plex finishing underneath (d.16 excluded).

Symbol Index   → • / present - / adsent OD / On Demand

LOTO

Pendant lamp - ø 140 x 160

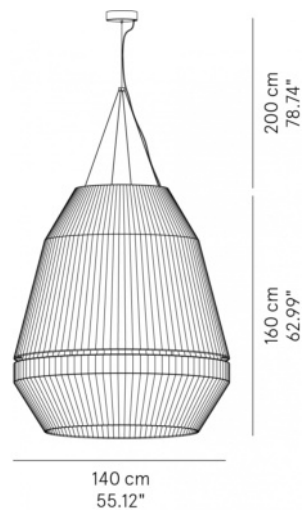

DESCRIZIONE

SORGENTE



IP

CODICE

Pendant lamp pleated fabric NO DIM

1 led module 88 W - 12380 Lm - 2700 K

OD

OD

IP20

LOTESP160P05

9.750

Pendant lamp pleated fabric DIM DALI-Push DIM

1 led module 88 W - 12380 Lm - 2700 K

OD

OD

IP20

LOTESP160P06

9.820

Pendant lamp pleated ribbon fabric NO DIM

1 led module 88 W - 12380 Lm - 2700 K

OD

OD

IP20

LOTESP160R05

9.750

Pendant lamp pleated ribbon fabric DIM DALI-Push DIM

1 led module 88 W - 12380 Lm - 2700 K

OD

OD

IP20

LOTESP160R06

9.820

NOTE: on demand, LED modules are also available in 3000K and 4000K, without surcharge.

-

0

PRODUCTS: Loto

DESIGN: design: Romano + Menegon 2008

Pendant and wall lamp in hand-finished pleated and pleated ribbon fabric.

Opal plex finishing underneath (d.16 excluded).

Symbol Index  → • / present - / adsent OD / On Demand

LOTO

DESCRIZIONE

SORGENTE



IP

CODICE

Wall lamp without switch

Wall lamp str. brushed nickel shade pleated

1xE14max watt 42 W HES

• OD IP20 LOTEAP016P01 390

Wall lamp str. brushed nickel shade pleated ribbon

1xE14max watt 42 W HES

OD OD IP20 LOTEAP016R01 410

24 cm
9.45"



24 cm
9.45"

16 cm
6.30"

16 cm
6.30"



24 cm
9.45"

24 cm
9.45"

Wall lamp with switch

Wall lamp str. brushed nickel shade pleated

1xE14max watt 42 W HES

• OD IP20 LOTEAP016P02 430

Wall lamp str. brushed nickel shade pleated ribbon

1xE14max watt 42 W HES

OD OD IP20 LOTEAP016R02 450

24 cm
9.45"



24 cm
9.45"

16 cm
6.30"

16 cm
6.30"



24 cm
9.45"



24 cm
9.45"

PRODUCTS: Lucilla**DESIGN:** design: Paolo Grasselli 2009

Small table, console, office, table, reading, floor and wall lamp.

Metal structure in matt black and white painted or in brushed nickel finishing.

Lampshade in cotton fabric, available in Kvadrat fabric upon demand (with surcharge).

Symbol Index   → • / present - / adsent OD / On Demand**LUCILLA****Small table lamp**45 cm
17.72"17 cm
6.69"**DESCRIZIONE****SORGENTE****IP****CODICE**

Metal white cotton

1xE14max watt 42 W HES

OD

OD

IP20

LUCETP042C01

400

Metal black cotton

1xE14max watt 42 W HES

OD

OD

IP20

LUCETP042C02

400

Metal brushed nickel cotton

1xE14max watt 42 W HES

OD

OD

IP20

LUCETP042C03

420

Console lamp55 cm
21.65"17 cm
6.69"

Metal white cotton

1xE14max watt 42 W HES

OD

OD

IP20

LUCECN056C01

405

Metal black cotton

1xE14max watt 42 W HES

OD

OD

IP20

LUCECN056C02

405

Metal brushed nickel cotton

1xE14max watt 42 W HES

OD

OD

IP20

LUCECN056C03

425

Office lamp - without switch50 cm
19.69"17 cm
6.69"

Metal white cotton

1xE14max watt 42 W HES

OD

OD

IP20

LUCEOF052C01

295

Metal black cotton

1xE14max watt 42 W HES

OD

OD

IP20

LUCEOF052C02

295

Metal brushed nickel cotton

1xE14max watt 42 W HES

OD

OD

IP20

LUCEOF052C03

305

PRODUCTS: Lucilla

DESIGN: design: Paolo Grasselli 2009

Small table, console, office, table, reading, floor and wall lamp.

Metal structure in matt black and white painted or in brushed nickel finishing.

Lampshade in cotton fabric, available in Kvadrat fabric upon demand (with surcharge).

Symbol Index  → • / present - / adsent OD / On Demand

LUCILLA

Table lamp

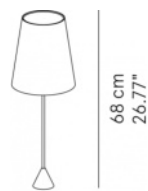

24 cm
9.45"

DESCRIZIONE

SORGENTE



IP

CODICE

Metal white cotton	1xE27max watt 52 W HES	OD	OD	IP20	LUCETA068C01	425
Metal black cotton	1xE27max watt 52 W HES	OD	OD	IP20	LUCETA068C02	425
Metal brushed nickel cotton	1xE27max watt 52 W HES	OD	OD	IP20	LUCETA068C03	445

Accessory - Table and small table lamp

Universal DIM switch HES (40/160W) + LED (4/100W)

DIMVAR0TA002 110



Reading lamp



24 cm
9.45"

Metal white cotton	1xE27max watt 52 W HES	OD	OD	IP20	LUCEPT150C01	755
Metal black cotton	1xE27max watt 52 W HES	OD	OD	IP20	LUCEPT150C02	755
Metal brushed nickel cotton	1xE27max watt 52 W HES	OD	OD	IP20	LUCEPT150C03	840

PRODUCTS: Lucilla

DESIGN: design: Paolo Grasselli 2009

Small table, console, office, table, reading, floor and wall lamp.

Metal structure in matt black and white painted or in brushed nickel finishing.

Lampshade in cotton fabric, available in Kvadrat fabric upon demand (with surcharge).

Symbol Index  → • / present - / adsent OD / On Demand

LUCILLA

Floor lamp



180 cm
70.87"

30 cm
11.81"

DESCRIZIONE

Metal white cotton

Metal black cotton

Metal brushed nickel cotton

SORGENTE

1xE27max watt 70 W HES

1xE27max watt 70 W HES

1xE27max watt 70 W HES



IP

CODICE

OD OD IP20 LUCEPT180C01 820

OD OD IP20 LUCEPT180C02 820

OD OD IP20 LUCEPT180C03 900

Accessory - Reading and floor lamp

Universal DIM switch HES + LED (5/250W)

OD

DIMVAROPT003

130



PRODUCTS: Lucilla

DESIGN: design: Paolo Grasselli 2009

Small table, console, office, table, reading, floor and wall lamp.

Metal structure in matt black and white painted or in brushed nickel finishing.

Lampshade in cotton fabric, available in Kvadrat fabric upon demand (with surcharge).

Symbol Index  → • / present - / adsent OD / On Demand

LUCILLA

DESCRIZIONE

SORGENTE



IP

CODICE

Wall lamp without switch

Metal white cotton

1xE14max watt 42 W HES

OD

OD

IP20

LUCEAP017C01

335

Metal black cotton

1xE14max watt 42 W HES

OD

OD

IP20

LUCEAP017C02

335

Metal brushed nickel cotton

1xE14max watt 42 W HES

OD

OD

IP20

LUCEAP017C03

360

17 cm
6.70"



26 cm
10.24"

24 cm
9.45"

Wall lamp with switch

Metal white cotton

1xE14max watt 42 W HES

OD

OD

IP20

LUCEAP017C06

380

Metal black cotton

1xE14max watt 42 W HES

OD

OD

IP20

LUCEAP017C07

380

Metal brushed nickel cotton

1xE14max watt 42 W HES

OD

OD

IP20

LUCEAP017C08

405

17 cm
6.70"



26 cm
10.24"

24 cm
9.45"

PRODUCTS: Milleluci

DESIGN: design: Modoluce R&D 2002



Pendant lamp with lampshade in cotton, pleated and pleated ribbon fabric.
On demand, lampshade available in velvet and wool fabrics (with surcharge).
Opal plex finishing underneath.

Symbol Index  → • / present - / absent OD / On Demand

MILLELUCI

Pendant lamp - ø 80



DESCRIZIONE	SORGENTE			IP	CODICE	
Cotton	4xE27max watt 70 W HES	OD	OD	IP20	MILESP080C01	1.200
Pendant lamp pleated fabric	4xE27max watt 70 W HES	OD	OD	IP20	MILESP080P01	1.690
Pleated ribbon fabric	4xE27max watt 70 W HES	OD	OD	IP20	MILESP080R01	1.750
Pendant lamp cotton NO DIM	1 led module 23 W - 3628 Lm - 2700 K	OD	OD	IP20	MILESP080C05	1.315
Pendant lamp cotton DIM TRIAC	1 led module 23 W - 3628 Lm - 2700 K	OD	OD	IP20	MILESP080C06	1.380
Pendant lamp cotton DIM DALI-Push DIM	1 led module 23 W - 3628 Lm - 2700 K	OD	OD	IP20	MILESP080C07	1.380
Pendant lamp pleated fabric NO DIM	1 led module 23 W - 3628 Lm - 2700 K	OD	OD	IP20	MILESP080P05	1.800
Pendant lamp pleated fabric DIM TRIAC	1 led module 23 W - 3628 Lm - 2700 K	OD	OD	IP20	MILESP080P06	1.875
Pendant lamp pleated fabric DIM DALI-Push DIM	1 led module 23 W - 3628 Lm - 2700 K	OD	OD	IP20	MILESP080P07	1.875
Pendant lamp pleated ribbon fabric NO DIM	1 led module 23 W - 3628 Lm - 2700 K	OD	OD	IP20	MILESP080R05	1.860
Pendant lamp pleated ribbon fabric DIM TRIAC	1 led module 23 W - 3628 Lm - 2700 K	OD	OD	IP20	MILESP080R06	1.925
Pendant lamp pleated ribbon fabric DIM DALI-Push DIM	1 led module 23 W - 3628 Lm - 2700 K	OD	OD	IP20	MILESP080R07	1.925

PRODUCTS: Milleluci
DESIGN: design: Modoluce R&D 2002



Pendant lamp with lampshade in cotton, pleated and pleated ribbon fabric.
 On demand, lampshade available in velvet and wool fabrics (with surcharge).
 Opal plex finishing underneath.

Symbol Index  → • / present - / adsent OD / On Demand

MILLELUCI

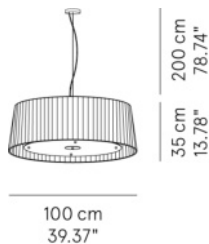
Pendant lamp - ø 100 x h 35



DESCRIZIONE	SORGENTE			IP	CODICE	
Cotton	4xE27max watt 70 W HES	OD	OD	IP20	MILESP035C01	1.420
Pendant lamp pleated fabric	4xE27max watt 70 W HES	OD	OD	IP20	MILESP035P01	2.020
Pleated ribbon fabric	4xE27max watt 70 W HES	OD	OD	IP20	MILESP035R01	2.105
Pendant lamp cotton NO DIM	1 led module 23 W - 3628 Lm - 2700 K	OD	OD	IP20	MILESP035C08	1.530
Pendant lamp cotton DIM TRIAC	1 led module 23 W - 3628 Lm - 2700 K	OD	OD	IP20	MILESP035C09	1.600
Pendant lamp cotton DIM DALI-Push DIM	1 led module 23 W - 3628 Lm - 2700 K	OD	OD	IP20	MILESP035C10	1.600
Pendant lamp pleated fabric NO DIM	1 led module 23 W - 3628 Lm - 2700 K	OD	OD	IP20	MILESP035P08	2.130
Pendant lamp pleated fabric DIM TRIAC	1 led module 23 W - 3628 Lm - 2700 K	OD	OD	IP20	MILESP035P09	2.200
Pendant lamp pleated fabric DIM DALI-Push DIM	1 led module 23 W - 3628 Lm - 2700 K	OD	OD	IP20	MILESP035P10	2.200
Pendant lamp pleated ribbon fabric NO DIM	1 led module 23 W - 3628 Lm - 2700 K	OD	OD	IP20	MILESP035R08	2.215
Pendant lamp pleated ribbon fabric DIM TRIAC	1 led module 23 W - 3628 Lm - 2700 K	OD	OD	IP20	MILESP035R09	2.290
Pendant lamp pleated ribbon fabric DIM DALI-Push DIM	1 led module 23 W - 3628 Lm - 2700 K	OD	OD	IP20	MILESP035R10	2.290
Pendant lamp cotton NO DIM	1 led module 57 W - 8750 Lm - 2700 K	OD	OD	IP20	MILESP035C13	1.740
Pendant lamp cotton DIM TRIAC	1 led module 57 W - 8750 Lm - 2700 K	OD	OD	IP20	MILESP035C14	1.805
Pendant lamp cotton DIM DALI-Push DIM	1 led module 57 W - 8750 Lm - 2700 K	OD	OD	IP20	MILESP035C15	1.850
Pendant lamp pleated fabric NO DIM	1 led module 57 W - 8750 Lm - 2700 K	OD	OD	IP20	MILESP035P13	2.335
Pendant lamp pleated fabric DIM TRIAC	1 led module 57 W - 8750 Lm - 2700 K	OD	OD	IP20	MILESP035P14	2.410
Pendant lamp pleated fabric DIM DALI-Push DIM	1 led module 57 W - 8750 Lm - 2700 K	OD	OD	IP20	MILESP035P15	2.445
Pendant lamp pleated ribbon fabric NO DIM	1 led module 57 W - 8750 Lm - 2700 K	OD	OD	IP20	MILESP035R13	2.425
Pendant lamp pleated ribbon fabric DIM TRIAC	1 led module 57 W - 8750 Lm - 2700 K	OD	OD	IP20	MILESP035R14	2.495
Pendant lamp pleated ribbon fabric DIM DALI-Push DIM	1 led module 57 W - 8750 Lm - 2700 K	OD	OD	IP20	MILESP035R15	2.535

PRODUCTS: Milleluci
DESIGN: design: Modoluce R&D 2002



Pendant lamp with lampshade in cotton, pleated and pleated ribbon fabric.
 On demand, lampshade available in velvet and wool fabrics (with surcharge).
 Opal plex finishing underneath.

Symbol Index  → • / present - / adsent OD / On Demand

MILLELUCI

Pendant lamp - ø 100 x h 60



DESCRIZIONE	SORGENTE			IP	CODICE	
Cotton	4xE27max watt 70 W HES	OD	OD	IP20	MILESP060C01	1.475
Pendant lamp pleated fabric	4xE27max watt 70 W HES	OD	OD	IP20	MILESP060P01	2.185
Pendant lamp pleated ribbon fabric	4xE27max watt 70 W HES	OD	OD	IP20	MILESP060R01	2.295
Pendant lamp cotton NO DIM	1 led module 23 W - 3628 Lm - 2700 K	OD	OD	IP20	MILESP060C08	1.585
Pendant lamp cotton DIM TRIAC	1 led module 23 W - 3628 Lm - 2700 K	OD	OD	IP20	MILESP060C09	1.655
Pendant lamp cotton DIM DALI-Push DIM	1 led module 23 W - 3628 Lm - 2700 K	OD	OD	IP20	MILESP060C10	1.655
Pendant lamp pleated fabric NO DIM	1 led module 23 W - 3628 Lm - 2700 K	OD	OD	IP20	MILESP060P08	2.295
Pendant lamp pleated fabric DIM TRIAC	1 led module 23 W - 3628 Lm - 2700 K	OD	OD	IP20	MILESP060P09	2.365
Pendant lamp pleated fabric DIM DALI-Push DIM	1 led module 23 W - 3628 Lm - 2700 K	OD	OD	IP20	MILESP060P10	2.365
Pendant lamp pleated ribbon fabric NO DIM	1 led module 23 W - 3628 Lm - 2700 K	OD	OD	IP20	MILESP060R08	2.405
Pendant lamp pleated ribbon fabric DIM TRIAC	1 led module 23 W - 3628 Lm - 2700 K	OD	OD	IP20	MILESP060R09	2.475
Pendant lamp pleated ribbon fabric DIM DALI-Push DIM	1 led module 23 W - 3628 Lm - 2700 K	OD	OD	IP20	MILESP060R10	2.475
Pendant lamp cotton NO DIM	1 led module 57 W - 8750 Lm - 2700 K	OD	OD	IP20	MILESP060C13	1.790
Pendant lamp cotton DIM TRIAC	1 led module 57 W - 8750 Lm - 2700 K	OD	OD	IP20	MILESP060C14	1.865
Pendant lamp cotton DIM DALI-Push DIM	1 led module 57 W - 8750 Lm - 2700 K	OD	OD	IP20	MILESP060C15	1.900
Pendant lamp pleated fabric NO DIM	1 led module 57 W - 8750 Lm - 2700 K	OD	OD	IP20	MILESP060P13	2.500
Pendant lamp pleated fabric DIM TRIAC	1 led module 57 W - 8750 Lm - 2700 K	OD	OD	IP20	MILESP060P14	2.575
Pendant lamp pleated fabric DIM DALI-Push DIM	1 led module 57 W - 8750 Lm - 2700 K	OD	OD	IP20	MILESP060P15	2.610
Pendant lamp pleated ribbon fabric NO DIM	1 led module 57 W - 8750 Lm - 2700 K	OD	OD	IP20	MILESP060R13	2.610
Pendant lamp pleated ribbon fabric DIM TRIAC	1 led module 57 W - 8750 Lm - 2700 K	OD	OD	IP20	MILESP060R14	2.685
Pendant lamp pleated ribbon fabric DIM DALI-Push DIM	1 led module 57 W - 8750 Lm - 2700 K	OD	OD	IP20	MILESP060R15	2.720

PRODUCTS: Milleluci
DESIGN: design: Modoluce R&D 2002



Pendant lamp with lampshade in cotton, pleated and pleated ribbon fabric.
 On demand, lampshade available in velvet and wool fabrics (with surcharge).
 Opal plex finishing underneath.

Symbol Index  → • / present - / adsent OD / On Demand

MILLELUCI

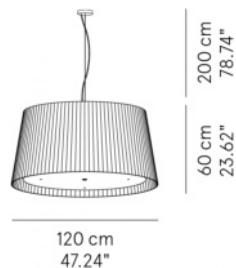
Pendant lamp - ø 120 x h 60



DESCRIZIONE	SORGENTE			IP	CODICE	
Cotton	4xE27max watt 70 W HES	OD	OD	IP20	MILESP120C01	2.265
Pendant lamp pleated fabric	4xE27max watt 70 W HES	OD	OD	IP20	MILESP120P01	3.055
Pleated ribbon fabric	4xE27max watt 70 W HES	OD	OD	IP20	MILESP120R01	3.185
Pendant lamp cotton NO DIM	1 led module 23 W - 3628 Lm - 2700 K	OD	OD	IP20	MILESP120C08	2.370
Pendant lamp cotton DIM TRIAC	1 led module 23 W - 3628 Lm - 2700 K	OD	OD	IP20	MILESP120C09	2.440
Pendant lamp cotton DIM DALI-Push DIM	1 led module 23 W - 3628 Lm - 2700 K	OD	OD	IP20	MILESP120C10	2.440
Pendant lamp pleated fabric NO DIM	1 led module 23 W - 3628 Lm - 2700 K	OD	OD	IP20	MILESP120P08	3.165
Pendant lamp pleated fabric DIM TRIAC	1 led module 23 W - 3628 Lm - 2700 K	OD	OD	IP20	MILESP120P09	3.240
Pendant lamp pleated fabric DIM DALI-Push DIM	1 led module 23 W - 3628 Lm - 2700 K	OD	OD	IP20	MILESP120P10	3.240
Pendant lamp pleated ribbon fabric NO DIM	1 led module 23 W - 3628 Lm - 2700 K	OD	OD	IP20	MILESP120R08	3.295
Pendant lamp pleated ribbon fabric DIM TRIAC	1 led module 23 W - 3628 Lm - 2700 K	OD	OD	IP20	MILESP120R09	3.370
Pendant lamp pleated ribbon fabric DIM DALI-Push DIM	1 led module 23 W - 3628 Lm - 2700 K	OD	OD	IP20	MILESP120R10	3.370
Pendant lamp cotton NO DIM	1 led module 57 W - 8750 Lm - 2700 K	OD	OD	IP20	MILESP120C11	2.580
Pendant lamp cotton DIM TRIAC	1 led module 57 W - 8750 Lm - 2700 K	OD	OD	IP20	MILESP120C12	2.645
Pendant lamp cotton DIM DALI-Push DIM	1 led module 57 W - 8750 Lm - 2700 K	OD	OD	IP20	MILESP120C13	2.645
Pendant lamp pleated fabric NO DIM	1 led module 57 W - 8750 Lm - 2700 K	OD	OD	IP20	MILESP120P11	3.375
Pendant lamp pleated fabric DIM TRIAC	1 led module 57 W - 8750 Lm - 2700 K	OD	OD	IP20	MILESP120P12	3.445
Pendant lamp pleated fabric DIM DALI-Push DIM	1 led module 57 W - 8750 Lm - 2700 K	OD	OD	IP20	MILESP120P13	3.445
Pendant lamp pleated ribbon fabric NO DIM	1 led module 57 W - 8750 Lm - 2700 K	OD	OD	IP20	MILESP120R11	3.505
Pendant lamp pleated ribbon fabric DIM TRIAC	1 led module 57 W - 8750 Lm - 2700 K	OD	OD	IP20	MILESP120R12	3.575
Pendant lamp pleated ribbon fabric DIM DALI-Push DIM	1 led module 57 W - 8750 Lm - 2700 K	OD	OD	IP20	MILESP120R13	3.575

PRODUCTS: Milleluci

DESIGN: design: Modoluce R&D 2002



Pendant lamp with lampshade in cotton, pleated and pleated ribbon fabric.
On demand, lampshade available in velvet and wool fabrics (with surcharge).
Opal plex finishing underneath.

Symbol Index  → • / present - / adsent OD / On Demand

MILLELUCI

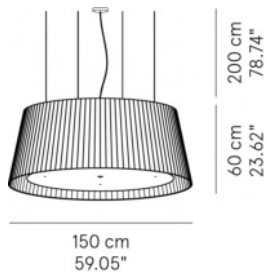
Pendant lamp - ø 150 x h 60



DESCRIZIONE	SORGENTE			IP	CODICE	
Pendant lamp pleated fabric	6xE27max watt 70 W HES	OD	OD	IP20	MILESP150P01	4.045
Pleated ribbon fabric	6xE27max watt 70 W HES	OD	OD	IP20	MILESP150R01	4.205
Pendant lamp pleated fabric NO DIM	1 led module 88 W - 12380 Lm - 2700 K	OD	OD	IP20	MILESP150P06	4.260
Pendant lamp pleated fabric DIM DALI-Push DIM	1 led module 88 W - 12380 Lm - 2700 K	OD	OD	IP20	MILESP150P07	4.370
Pendant lamp pleated ribbon fabric NO DIM	1 led module 88 W - 12380 Lm - 2700 K	OD	OD	IP20	MILESP150R06	4.420
Pendant lamp pleated ribbon fabric DIM DALI-Push DIM	1 led module 88 W - 12380 Lm - 2700 K	OD	OD	IP20	MILESP150R07	4.530

NOTE: on demand, LED modules are also available in 3000K and 4000K, without surcharge.

- 0

PRODUCTS: Milleluci Soft

DESIGN: design: Modoluce R&D 2025

Pendant lamp with lampshade in velvet and wool fabric.

On demand, lampshade available in For nature, Kvadrat and cubic fabrics (with surcharge).



Opal plex finishing underneath.

Symbol Index  → • / present - / adsent OD / On Demand

MILLELUCI SOFT

Pendant lamp - ø 85



DESCRIZIONE	SORGENTE			IP	CODICE	
Pendant lamp velvet	4xE27max watt 70 W HES	OD	OD	IP20	MISESP085O02	2.590
Pendant lamp wool	4xE27max watt 70 W HES	OD	OD	IP20	MISESP085E02	2.590
Pendant lamp velvet NO DIM	1 led module 23 W - 3628 Lm - 2700 K	OD	OD	IP20	MISESP085O03	2.690
Wool NO DIM	1 led module 23 W - 3628 Lm - 2700 K	OD	OD	IP20	MISESP085E03	2.690
Pendant lamp velvet DIM TRIAC	1 led module 23 W - 3628 Lm - 2700 K	OD	OD	IP20	MISESP085O04	2.760
Pendant lamp wool DIM TRIAC	1 led module 23 W - 3628 Lm - 2700 K	OD	OD	IP20	MISESP085E04	2.760
Pendant lamp velvet DIM DALI-Push DIM	1 led module 23 W - 3628 Lm - 2700 K	OD	OD	IP20	MISESP085O05	2.760
Wool DIM DALI-Push DIM	1 led module 23 W - 3628 Lm - 2700 K	OD	OD	IP20	MISESP085E05	2.760

PRODUCTS: Milleluci Soft
DESIGN: design: Modoluce R&D 2025

Pendant lamp with lampshade in velvet and wool fabric.
 On demand, lampshade available in For nature, Kvadrat and cubic fabrics (with surcharge).
 Opal plex finishing underneath.

Symbol Index  → • / present - / adsent OD / On Demand

MILLELUCI SOFT

Pendant lamp - ø 125



DESCRIZIONE	SORGENTE			IP	CODICE	
Pendant lamp velvet	4xE27max watt 70 W HES	OD	OD	IP20	MISESP125O02	3.330
Pendant lamp wool	4xE27max watt 70 W HES	OD	OD	IP20	MISESP125E02	3.330
Pendant lamp velvet NO DIM	1 led module 23 W - 3628 Lm - 2700 K	OD	OD	IP20	MISESP125O03	3.405
Wool NO DIM	1 led module 23 W - 3628 Lm - 2700 K	OD	OD	IP20	MISESP125E03	3.405
Pendant lamp velvet DIM TRIAC	1 led module 23 W - 3628 Lm - 2700 K	OD	OD	IP20	MISESP125O04	3.485
Pendant lamp wool DIM TRIAC	1 led module 23 W - 3628 Lm - 2700 K	OD	OD	IP20	MISESP125E04	3.485
Pendant lamp velvet DIM DALI-Push DIM	1 led module 23 W - 3628 Lm - 2700 K	OD	OD	IP20	MISESP125O05	3.485
Wool DIM DALI-Push DIM	1 led module 23 W - 3628 Lm - 2700 K	OD	OD	IP20	MISESP125E05	3.485
Pendant lamp velvet NO DIM	1 led module 88 W - 12380 Lm - 2700 K	OD	OD	IP20	MISESP125O06	3.660
Wool NO DIM	1 led module 88 W - 12380 Lm - 2700 K	OD	OD	IP20	MISESP125E06	3.660
Pendant lamp velvet DIM DALI-Push DIM	1 led module 88 W - 12380 Lm - 2700 K	OD	OD	IP20	MISESP125O07	3.710
Wool DIM DALI-Push DIM	1 led module 88 W - 12380 Lm - 2700 K	OD	OD	IP20	MISESP125E07	3.710

PRODUCTS: Milleluci Soft

DESIGN: design: Modoluce R&D 2025

Pendant lamp with lampshade in velvet and wool fabric.

On demand, lampshade available in For nature, Kvadrat and cubic fabrics (with surcharge).



Opal plex finishing underneath.

Symbol Index  → • / present - / adsent OD / On Demand

MILLELUCI SOFT

Pendant lamp - ø 145



DESCRIZIONE	SORGENTE			IP	CODICE	
Pendant lamp velvet	6xE27max watt 70 W HES	OD	OD	IP20	MISESP145002	4.315
Pendant lamp wool	6xE27max watt 70 W HES	OD	OD	IP20	MISESP145E02	4.315
Pendant lamp velvet NO DIM	1 led module 88 W - 12380 Lm - 2700 K	OD	OD	IP20	MISESP145006	4.470
Wool NO DIM	1 led module 88 W - 12380 Lm - 2700 K	OD	OD	IP20	MISESP145E06	4.470
Pendant lamp velvet DIM DALI-Push DIM	1 led module 88 W - 12380 Lm - 2700 K	OD	OD	IP20	MISESP145007	4.520
Wool DIM DALI-Push DIM	1 led module 88 W - 12380 Lm - 2700 K	OD	OD	IP20	MISESP145E07	4.520

NOTE: on demand, LED modules are also available in 3000K and 4000K, without surcharge.

- 0

PRODUCTS: Mood

DESIGN: design: Romano + Menegon 2014

Pendant, wall/ ceiling lamp with lampshade in hand-finished pleated or pleated ribbon fabric.
Bottom cap in thermoformed opal PMMA with soft touch finishing.

Symbol Index  → • / present - / adsent OD / On Demand

MOOD

Pendant lamp - ø 100

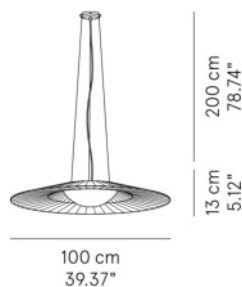

DESCRIZIONE

SORGENTE



IP

CODICE

1 light pleated fabric NO DIM	1 led module 23 W - 3628 Lm - 2700 K	OD	OD	IP20	MOOESO100P04	2.065
1 light pleated fabric DIM TRIAC	1 led module 23 W - 3628 Lm - 2700 K	OD	OD	IP20	MOOESO100P05	2.140
1 light pleated fabric DIM DALI-Push DIM	1 led module 23 W - 3628 Lm - 2700 K	OD	OD	IP20	MOOESO100P06	2.155
1 light pleated ribbon fabric NO DIM	1 led module 23 W - 3628 Lm - 2700 K	OD	OD	IP20	MOOESO100R04	2.085
1 light pleated ribbon fabric DIM TRIAC	1 led module 23 W - 3628 Lm - 2700 K	OD	OD	IP20	MOOESO100R05	2.165
1 light pleated ribbon fabric DIM DALI-Push DIM	1 led module 23 W - 3628 Lm - 2700 K	OD	OD	IP20	MOOESO100R06	2.175

Pendant lamp - ø 120

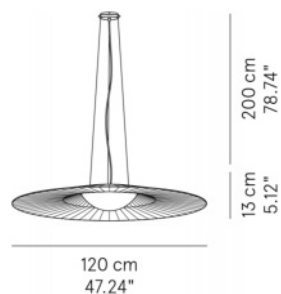



1 light pleated fabric NO DIM	1 led module 23 W - 3628 Lm - 2700 K	OD	OD	IP20	MOOESO120P04	2.500
1 light pleated fabric DIM TRIAC	1 led module 23 W - 3628 Lm - 2700 K	OD	OD	IP20	MOOESO120P05	2.580
1 light pleated fabric DIM DALI-Push DIM	1 led module 23 W - 3628 Lm - 2700 K	OD	OD	IP20	MOOESO120P06	2.590
1 light pleated ribbon fabric NO DIM	1 led module 23 W - 3628 Lm - 2700 K	OD	OD	IP20	MOOESO120R04	2.535
1 light pleated ribbon fabric DIM TRIAC	1 led module 23 W - 3628 Lm - 2700 K	OD	OD	IP20	MOOESO120R05	2.610
1 light pleated ribbon fabric DIM DALI-Push DIM	1 led module 23 W - 3628 Lm - 2700 K	OD	OD	IP20	MOOESO120R06	2.620

PRODUCTS: Mood

DESIGN: design: Romano + Menegon 2014

Pendant, wall/ ceiling lamp with lampshade in hand-finished pleated or pleated ribbon fabric.
Bottom cap in thermoformed opal PMMA with soft touch finishing.

Symbol Index   → • / present - / adsent OD / On Demand

MOOD

Pendant lamp - ø 150

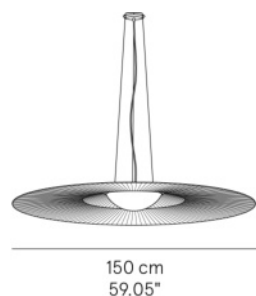

DESCRIZIONE

SORGENTE



IP

CODICE

1 light pleated fabric NO DIM	1 led module 23 W - 3628 Lm - 2700 K	OD	OD	IP20	MOOESO150P04	2.895
1 light pleated fabric DIM TRIAC	1 led module 23 W - 3628 Lm - 2700 K	OD	OD	IP20	MOOESO150P05	2.970
1 light pleated fabric DIM DALI-Push DIM	1 led module 23 W - 3628 Lm - 2700 K	OD	OD	IP20	MOOESO150P06	2.980
1 light pleated ribbon fabric NO DIM	1 led module 23 W - 3628 Lm - 2700 K	OD	OD	IP20	MOOESO150R04	2.950
1 light pleated ribbon fabric DIM TRIAC	1 led module 23 W - 3628 Lm - 2700 K	OD	OD	IP20	MOOESO150R05	3.025
1 light pleated ribbon fabric DIM DALI-Push DIM	1 led module 23 W - 3628 Lm - 2700 K	OD	OD	IP20	MOOESO150R06	3.035

Wall/Ceiling lamp - ø 80

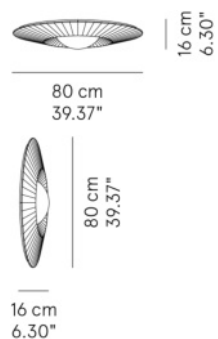

1 light pleated fabric NO DIM	1 led module 23 W - 3628 Lm - 2700 K	OD	OD	IP20	MOOEAP080P04	2.000
1 light pleated fabric DIM TRIAC	1 led module 23 W - 3628 Lm - 2700 K	OD	OD	IP20	MOOEAP080P05	2.075
1 light pleated fabric DIM DALI-Push DIM	1 led module 23 W - 3628 Lm - 2700 K	OD	OD	IP20	MOOEAP080P06	2.040
1 light pleated ribbon fabric NO DIM	1 led module 23 W - 3628 Lm - 2700 K	OD	OD	IP20	MOOEAP080R04	2.020
1 light pleated ribbon fabric DIM TRIAC	1 led module 23 W - 3628 Lm - 2700 K	OD	OD	IP20	MOOEAP080R05	2.095
1 light pleated ribbon fabric DIM DALI-Push DIM	1 led module 23 W - 3628 Lm - 2700 K	OD	OD	IP20	MOOEAP080R06	2.065

NOTE: on demand, LED modules are also available in 3000K and 4000K, without surcharge.

- 0

PRODUCTS: Multiball

DESIGN: design: Roberto Paoli 2013

Single or infinitely aggregating pendant lamps through dedicated connection, available in various heights.

Matt white or black painted metal structure. Globe diffuser in white PMMA.

On demand, globe available in polycarbonate (quantity to be defined), in accordance with the CL1 (650°) fire normative, with surcharge.



Symbol Index  → • / present - / absent OD / On Demand

MULTIBALL

Pendant lamp globe - ø 25



25 cm
9.84"

DESCRIZIONE	SORGENTE			IP	CODICE	
Pendant lamp h 36	1xE27max watt 42 W HES	OD	OD	IP20	MBLESO025M10	400
Pendant lamp h 46	1xE27max watt 42 W HES	OD	OD	IP20	MBLESO025M20	400
Pendant lamp h 56	1xE27max watt 42 W HES	OD	OD	IP20	MBLESO025M30	400
Pendant lamp h 66	1xE27max watt 42 W HES	OD	OD	IP20	MBLESO025M40	400
Pendant lamp h 76	1xE27max watt 42 W HES	OD	OD	IP20	MBLESO025M50	405
Pendant lamp h 86	1xE27max watt 42 W HES	OD	OD	IP20	MBLESO025M60	405
Pendant lamp h 96	1xE27max watt 42 W HES	OD	OD	IP20	MBLESO025M70	405
Pendant lamp h 106	1xE27max watt 42 W HES	OD	OD	IP20	MBLESO025M80	405

A

Pendant lamp globe - ø 30



30 cm
11.81"

Pendant lamp h 41	1xE27max watt 52 W HES	OD	OD	IP20	MBLESO030M10	410
Pendant lamp h 51	1xE27max watt 52 W HES	OD	OD	IP20	MBLESO030M20	410
Pendant lamp h 61	1xE27max watt 52 W HES	OD	OD	IP20	MBLESO030M30	410
Pendant lamp h 71	1xE27max watt 52 W HES	OD	OD	IP20	MBLESO030M40	410
Pendant lamp h 81	1xE27max watt 52 W HES	OD	OD	IP20	MBLESO030M50	415
Pendant lamp h 91	1xE27max watt 52 W HES	OD	OD	IP20	MBLESO030M60	415
Pendant lamp h 101	1xE27max watt 52 W HES	OD	OD	IP20	MBLESO030M70	415
Pendant lamp h 111	1xE27max watt 52 W HES	OD	OD	IP20	MBLESO030M80	415

B

PRODUCTS: Multiball

DESIGN: design: Roberto Paoli 2013

Single or infinitely aggregating pendant lamps through dedicated connection, available in various heights.

Matt white or black painted metal structure. Globe diffuser in white PMMA.

On demand, globe available in polycarbonate (quantity to be defined), in accordance with the CL1 (650°) fire normative, with surcharge.

Symbol Index  → • / present - / absent OD / On Demand



MULTIBALL

Pendant lamp globe - ø 35



35 cm
13.78"

C

DESCRIZIONE	SORGENTE			IP	CODICE	
Pendant lamp h 46	1xE27max watt 52 W HES	OD	OD	IP20	MBLESO035M10	465
Pendant lamp h 56	1xE27max watt 52 W HES	OD	OD	IP20	MBLESO035M20	465
Pendant lamp h 66	1xE27max watt 52 W HES	OD	OD	IP20	MBLESO035M30	465
Pendant lamp h 76	1xE27max watt 52 W HES	OD	OD	IP20	MBLESO035M40	465
Pendant lamp h 86	1xE27max watt 52 W HES	OD	OD	IP20	MBLESO035M50	475
Pendant lamp h 96	1xE27max watt 52 W HES	OD	OD	IP20	MBLESO035M60	475
Pendant lamp h 106	1xE27max watt 52 W HES	OD	OD	IP20	MBLESO035M70	475
Pendant lamp h 116	1xE27max watt 52 W HES	OD	OD	IP20	MBLESO035M80	475

Pendant lamp globe - ø 40



40 cm
15.75"

D

Pendant lamp h 51	1xE27max watt 70 W HES	OD	OD	IP20	MBLESO040M10	495
Pendant lamp h 61	1xE27max watt 70 W HES	OD	OD	IP20	MBLESO040M20	495
Pendant lamp h 71	1xE27max watt 70 W HES	OD	OD	IP20	MBLESO040M30	495
Pendant lamp h 81	1xE27max watt 70 W HES	OD	OD	IP20	MBLESO040M40	495
Pendant lamp h 91	1xE27max watt 70 W HES	OD	OD	IP20	MBLESO040M50	500
Pendant lamp h 101	1xE27max watt 70 W HES	OD	OD	IP20	MBLESO040M60	500
Pendant lamp h 111	1xE27max watt 70 W HES	OD	OD	IP20	MBLESO040M70	500
Pendant lamp h 121	1xE27max watt 70 W HES	OD	OD	IP20	MBLESO040M80	500

PRODUCTS: Multiball

DESIGN: design: Roberto Paoli 2013

Single or infinitely aggregating pendant lamps through dedicated connection, available in various heights.

Matt white or black painted metal structure. Globe diffuser in white PMMA.

On demand, globe available in polycarbonate (quantity to be defined), in accordance with the CL1 (650°) fire normative, with surcharge.

Symbol Index  → • / present - / adsent OD / On Demand

MULTIBALL

Pendant lamp globe - ø 45



45 cm
17.72"

E

DESCRIZIONE

SORGENTE



IP

CODICE

DESCRIZIONE	SORGENTE	Energy Efficiency	CE	IP	CODICE	Price
Pendant lamp h 56	1xE27max watt 70 W HES	OD	OD	IP20	MBLES0045M10	565
Pendant lamp h 66	1xE27max watt 70 W HES	OD	OD	IP20	MBLES0045M20	565
Pendant lamp h 76	1xE27max watt 70 W HES	OD	OD	IP20	MBLES0045M30	565
Pendant lamp h 86	1xE27max watt 70 W HES	OD	OD	IP20	MBLES0045M40	565
Pendant lamp h 96	1xE27max watt 70 W HES	OD	OD	IP20	MBLES0045M50	570
Pendant lamp h 106	1xE27max watt 70 W HES	OD	OD	IP20	MBLES0045M60	570
Pendant lamp h 116	1xE27max watt 70 W HES	OD	OD	IP20	MBLES0045M70	570
Pendant lamp h 126	1xE27max watt 70 W HES	OD	OD	IP20	MBLES0045M80	570

Accessory - Cable/s cover white or black matt painted

Connection cables L 40 (electric cable included)	•	OD	IP20	MBLEAS000G01	80
Connection cables L 80 (electric cable included)	•	OD	IP20	MBLEAS000G02	115
Separate ceiling rose attachment	•	OD	IP20	MBLEAR000G01	150

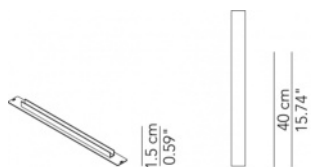

40 cm 15.74"
1.5 cm 0.59"
3.5 cm 1.37"

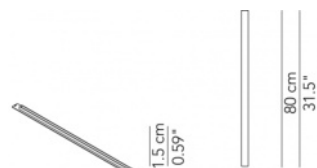

80 cm 31.5"
1.5 cm 0.59"
3.5 cm 1.37"



PRODUCTS: Multiball

DESIGN: design: Roberto Paoli 2013

Single or infinitely aggregating pendant lamps through dedicated connection, available in various heights.

Matt white or black painted metal structure. Globe diffuser in white PMMA.

On demand, globe available in polycarbonate (quantity to be defined), in accordance with the CL1 (650°) fire normative, with surcharge.

Symbol Index   → • / present - / absent OD / On Demand

MULTIBALL

DESCRIZIONE

SORGENTE



IP

CODICE

Examples of compositions:

Composition type 1 - (3 globes)

Composition with h 56 maximum encumbrance

OD OD IP20 MBLECM056M03 1.430

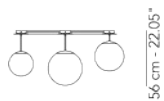

Composition with h 86 maximum encumbrance

OD OD IP20 MBLECM086M03 1.445

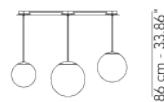

Composition type 2 - (5 globes)

Composition with h 66 maximum encumbrance

OD OD IP20 MBLECM066M05 2.640

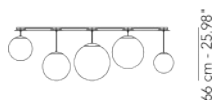

Composition with h 86 maximum encumbrance

OD OD IP20 MBLECM086M05 2.650

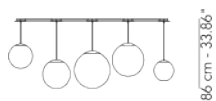

PRODUCTS: Multiball

DESIGN: design: Roberto Paoli 2013

Single or infinitely aggregating pendant lamps through dedicated connection, available in various heights.

Matt white or black painted metal structure. Globe diffuser in white PMMA.

On demand, globe available in polycarbonate (quantity to be defined), in accordance with the CL1 (650°) fire normative, with surcharge.

Symbol Index  → • / present - / absent OD / On Demand

MULTIBALL

DESCRIZIONE

SORGENTE



IP

CODICE

Composition type 3 - (8 globes)

Composition with h 66 maximum encumbrance

OD OD IP20 MBLECM066M08 4.340

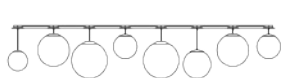

66 cm - 25.98"

Composition with h 96 maximum encumbrance

OD OD IP20 MBLECM096M08 4.365

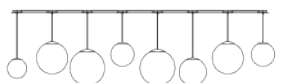

96 cm - 37.79"

PRODUCTS: Nucleo

DESIGN: design: Bellucci Mazzoni Progetti 2019

Elliptical-shape pendant lamp.

Metal structure painted in white, graphite or bronze.

Diffuser sliding inside the structure, painted in white, graphite or bronze and in galvanic finishes brass and copper.

Double light emission versions: L 130 Up 200 lm - Down 2150 lm / L 160 Up 400 lm - Down 4300 lm

Symbol Index  → • / present - / absent OD / On Demand

NUCLEO

DESCRIZIONE

SORGENTE



IP

CODICE

Pendant lamp - L 130

Structure only white, graphite or bronze

• OD IP20 NUCESO130G01 910

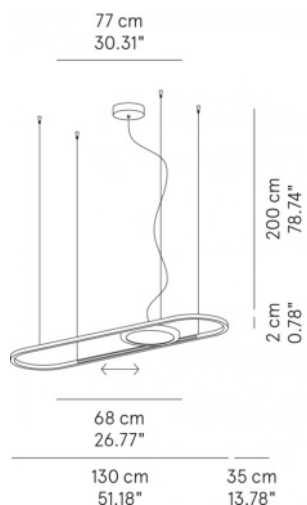

Direct light:

Kit 1 light white, graphite ou bronze NO DIM (installed)

1 led module 24 W - 2150 Lm - 3000 K - >85

• OD IP20 NUCEDD130G01 540

Kit 1 light brass or copper NO DIM (installed)

1 led module 24 W - 2150 Lm - 3000 K - >85

• OD IP20 NUCEDD130G02 775

Kit 1 light white, graphite ou bronze DIM TRIAC (installed)

1 led module 24 W - 2150 Lm - 3000 K - >85

• OD IP20 NUCEDD130G03 640

Kit 1 light brass or copper DIM TRIAC (installed)

1 led module 24 W - 2150 Lm - 3000 K - >85

• OD IP20 NUCEDD130G04 870

Kit 1 light white, graphite ou bronze DIM DALI - Push DIM (installed)

1 led module 24 W - 2150 Lm - 3000 K - >85

• OD IP20 NUCEDD130G06 775

Kit 1 light brass or copper DIM DALI - Push DIM (installed)

1 led module 24 W - 2150 Lm - 3000 K - >85

• OD IP20 NUCEDD130G07 1.010

Double light emission:

Kit 2 lights white, graphite ou bronze NO DIM/ DIM DALI - Push DIM (installed)

2 led module 24W + 3W - 2350 Lm - 2800 K

• OD IP20 NUCEDD130G16 860

Kit 2 lights brass or copper NO DIM/ DIM DALI - Push DIM (installed)

2 led module 24W + 3W - 2350 Lm - 2800 K

• OD IP20 NUCEDD130G17 1.095

ATTENTION: to calculate the price of the pendant lamp add the structure to the kit 1 or 2 lights

- 0

PRODUCTS: Nucleo

DESIGN: design: Bellucci Mazzoni Progetti 2019

Elliptical-shape pendant lamp.

Metal structure painted in white, graphite or bronze.

Diffuser sliding inside the structure, painted in white, graphite or bronze and in galvanic finishes brass and copper.

Double light emission versions: L 130 Up 200 lm - Down 2150 lm / L 160 Up 400 lm - Down 4300 lm

Symbol Index  → • / present - / absent OD / On Demand

NUCLEO

DESCRIZIONE

SORGENTE



IP

CODICE

Connection single cable ceiling attachment available on demand

- 0



Pendant lamp - L 160

Structure only white, graphite or bronze

• OD IP20 NUCESO160G01 1.015

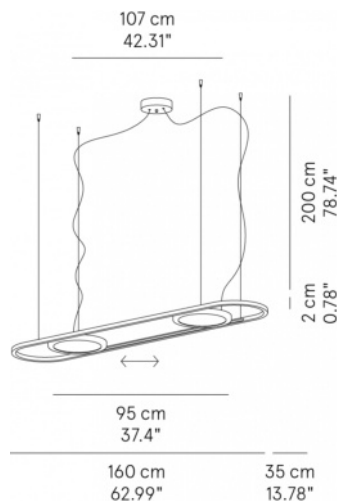

Direct light:

- 0

Kit 2 lights white, graphite ou bronze NO DIM (installed)

2 led module 24W - 4300 Lm - 2800 K - >85

• OD IP20 NUCEDD160G01 980

Kit 2 lights brass or copper NO DIM (installed)

2 led module 24W - 4300 Lm - 2800 K - >85

• OD IP20 NUCEDD160G02 1.440

Kit 2 lights white, graphite ou bronze DIM TRIAC (installed)

2 led module 24W - 4300 Lm - 2800 K - >85

• OD IP20 NUCEDD160G03 1.175

Kit 2 lights brass or copper DIM TRIAC (installed)

2 led module 24W - 4300 Lm - 2800 K - >85

• OD IP20 NUCEDD160G04 1.630

Kit 2 lights white, graphite ou bronze DIM DALI - Push DIM (installed)

2 led module 24W - 4300 Lm - 2800 K - >85

• OD IP20 NUCEDD160G06 1.330

Kit 2 lights brass or copper DIM DALI - Push DIM (installed)

2 led module 24W - 4300 Lm - 2800 K - >85

• OD IP20 NUCEDD160G07 1.780

Double light emission:

- 0

Kit 4 lights white, graphite ou bronze NO DIM/ DIM DALI - Push DIM (installed)

4 led module 2 x (24W + 3W) - 4700 Lm - 2800 K

• OD IP20 NUCEDD160G16 1.490

Kit 4 lights brass or copper NO DIM/ DIM DALI - Push DIM (installed)

4 led module 2 x (24W + 3W) - 4700 Lm - 2800 K

• OD IP20 NUCEDD160G17 1.945

PRODUCTS: Nucleo



DESIGN: design: Bellucci Mazzoni Progetti 2019

Elliptical-shape pendant lamp.

Metal structure painted in white, graphite or bronze.

Diffuser sliding inside the structure, painted in white, graphite or bronze and in galvanic finishes brass and copper.

Double light emission versions: L 130 Up 200 lm - Down 2150 lm / L 160 Up 400 lm - Down 4300 lm

Symbol Index   → • / present - / adsent OD / On Demand

NUCLEO

DESCRIZIONE

SORGENTE



IP

CODICE

ATTENTION: to calculate the price of the pendant lamp add the structure to the kit 2 or 4 lights

- 0

Connection single cable ceiling attachment available on demand

- 0





PRODUCTS: Ombrella

DESIGN: design: Paolo Grasselli 2015

Pendant, ceiling lamp in matt white painted metal.

Upper disc available in gold leaf finishing (surcharge as per price list).



Lower bowl available in white or black painted and in galvanized finishes: brass or copper.

Symbol Index   → • / present - / absent OD / On Demand

OMBRELLA

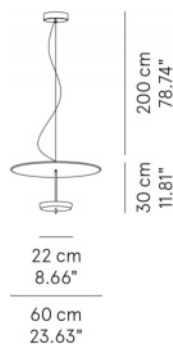
Pendant lamp D.60



DESCRIZIONE	SORGENTE	 	IP	CODICE	
Pendant lamp white lower bowl white or black NO DIM	1 led module 18 W - 3200 Lm - 3000 K	•	OD IP20	UMBESO060G01	675
Pendant lamp white lower bowl white or black DIM TRIAC	1 led module 18 W - 3200 Lm - 3000 K	•	OD IP20	UMBESO060G04	710
Pendant lamp white lower bowl white or black DIM DALI-Push DIM	1 led module 18 W - 3200 Lm - 3000 K	•	OD IP20	UMBESO060G11	800
Pendant lamp white lower bowl in galvanized finishes NO DIM	1 led module 18 W - 3200 Lm - 3000 K	•	OD IP20	UMBESO060G03	780
Pendant lamp white lower bowl in galvanized finishes DIM TRIAC	1 led module 18 W - 3200 Lm - 3000 K	•	OD IP20	UMBESO060G05	815
Pendant lamp white lower bowl in galvanized finishes DIM DALI-Push DIM	1 led module 18 W - 3200 Lm - 3000 K	•	OD IP20	UMBESO060G13	905
LED temperature conversion filter from 3000K to 2700K	1 led module 18 W - 3200 Lm - 3000 K	•	OD IP20	FLTCON0SP001	85
Surcharge gold leaf finish				UMBORO060G01	275

Pendant lamp D.80

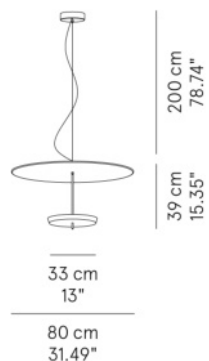

Pendant lamp white lower bowl white or black NO DIM	1 led module 23 W - 4425 Lm - 3000 K	•	OD IP20	UMBESO080G01	1.145
Pendant lamp white lower bowl white or black DIM TRIAC	1 led module 23 W - 4425 Lm - 3000 K	•	OD IP20	UMBESO080G04	1.235
Pendant lamp white lower bowl white or black DIM DALI-Push DIM	1 led module 23 W - 4425 Lm - 3000 K	•	OD IP20	UMBESO080G11	1.255
Pendant lamp white lower bowl in galvanized finishes NO DIM	1 led module 23 W - 4425 Lm - 3000 K	•	OD IP20	UMBESO080G03	1.275
Pendant lamp white lower bowl in galvanized finishes DIM TRIAC	1 led module 23 W - 4425 Lm - 3000 K	•	OD IP20	UMBESO080G05	1.365
Pendant lamp white lower bowl in galvanized finishes DIM DALI-Push DIM	1 led module 23 W - 4425 Lm - 3000 K	•	OD IP20	UMBESO080G13	1.395
LED temperature conversion filter from 3000K to 2700K	1 led module 23 W - 4425 Lm - 3000 K	•	OD IP20	FLTCON0SP011	105
Surcharge gold leaf finish				UMBORO080G01	325

PRODUCTS: Ombrella

DESIGN: design: Paolo Grasselli 2015

Pendant, ceiling lamp in matt white painted metal.

Upper disc available in gold leaf finishing (surcharge as per price list).



Lower bowl available in white or black painted and in galvanized finishes: brass or copper.

Symbol Index  → • / present - / adsent OD / On Demand

OMBRELLA

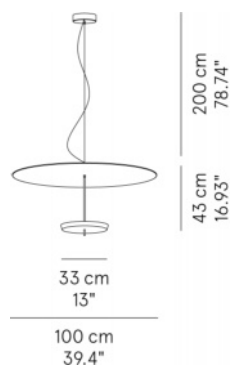
Pendant lamp D.100



DESCRIZIONE	SORGENTE			IP	CODICE	
Pendant lamp white lower bowl white or black NO DIM	1 led module 23 W - 4425 Lm - 3000 K	•	OD	IP20	UMBESO100G01	1.215
Pendant lamp white lower bowl white or black DIM TRIAC	1 led module 23 W - 4425 Lm - 3000 K	•	OD	IP20	UMBESO100G04	1.300
Pendant lamp white lower bowl white or black DIM DALI-Push DIM	1 led module 23 W - 4425 Lm - 3000 K	•	OD	IP20	UMBESO100G11	1.335
Pendant lamp white lower bowl in galvanized finishes NO DIM	1 led module 23 W - 4425 Lm - 3000 K	•	OD	IP20	UMBESO100G03	1.345
Pendant lamp white lower bowl in galvanized finishes DIM TRIAC	1 led module 23 W - 4425 Lm - 3000 K	•	OD	IP20	UMBESO100G05	1.430
Pendant lamp white lower bowl in galvanized finishes DIM DALI-Push DIM	1 led module 23 W - 4425 Lm - 3000 K	•	OD	IP20	UMBESO100G13	1.465
LED temperature conversion filter from 3000K to 2700K	1 led module 23 W - 4425 Lm - 3000 K	•	OD	IP20	FLTCON0SP011	105
Surcharge gold leaf finish					UMBORO100G01	385

Ceiling lamp D.60

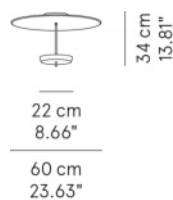

Ceiling lamp white lower bowl white or black NO DIM	1 led module 18 W - 3200 Lm - 3000 K	•	OD	IP20	UMBEPLO60G01	720
Ceiling lamp white lower bowl white or black DIM TRIAC	1 led module 18 W - 3200 Lm - 3000 K	•	OD	IP20	UMBEPLO60G04	755
Ceiling lamp white lower bowl white or black DIM DALI-Push DIM	1 led module 18 W - 3200 Lm - 3000 K	•	OD	IP20	UMBEPLO60G11	840
Ceiling lamp white lower bowl in galvanized finishes NO DIM	1 led module 18 W - 3200 Lm - 3000 K	•	OD	IP20	UMBEPLO60G03	825
Ceiling lamp white lower bowl in galvanized finishes DIM TRIAC	1 led module 18 W - 3200 Lm - 3000 K	•	OD	IP20	UMBEPLO60G05	855
Ceiling lamp white lower bowl in galvanized finishes DIM DALI-Push DIM	1 led module 18 W - 3200 Lm - 3000 K	•	OD	IP20	UMBEPLO60G13	945
LED temperature conversion filter from 3000K to 2700K	1 led module 18 W - 3200 Lm - 3000 K	•	OD	IP20	FLTCON0SP001	85
Surcharge gold leaf finish					UMBORO060G01	275

PRODUCTS: Ombrella

DESIGN: design: Paolo Grasselli 2015

Pendant, ceiling lamp in matt white painted metal.

Upper disc available in gold leaf finishing (surcharge as per price list).



Lower bowl available in white or black painted and in galvanized finishes: brass or copper.

Symbol Index  → • / present - / adsent OD / On Demand

OMBRELLA

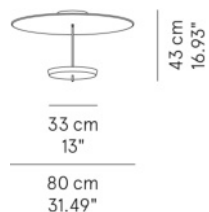
Ceiling lamp D.80



DESCRIZIONE	SORGENTE			IP	CODICE	
Ceiling lamp white lower bowl white or black NO DIM	1 led module 23 W - 4425 Lm - 3000 K	•	OD	IP20	UMBEPL080G01	1.190
Ceiling lamp white lower bowl white or black DIM TRIAC	1 led module 23 W - 4425 Lm - 3000 K	•	OD	IP20	UMBEPL080G04	1.265
Ceiling lamp white lower bowl white or black DIM DALI-Push DIM	1 led module 23 W - 4425 Lm - 3000 K	•	OD	IP20	UMBEPL080G11	1.300
Ceiling lamp white lower bowl in galvanized finishes NO DIM	1 led module 23 W - 4425 Lm - 3000 K	•	OD	IP20	UMBEPL080G03	1.325
Ceiling lamp white lower bowl in galvanized finishes DIM TRIAC	1 led module 23 W - 4425 Lm - 3000 K	•	OD	IP20	UMBEPL080G05	1.395
Ceiling lamp white lower bowl in galvanized finishes DIM DALI-Push DIM	1 led module 23 W - 4425 Lm - 3000 K	•	OD	IP20	UMBEPL080G13	1.430
LED temperature conversion filter from 3000K to 2700K	1 led module 23 W - 4425 Lm - 3000 K	•	OD	IP20	FLTCON0SP011	105
Surcharge gold leaf finish					UMBORO080G01	325

Ceiling lamp D.100

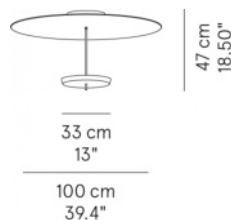

Ceiling lamp white lower bowl white or black NO DIM	1 led module 23 W - 4425 Lm - 3000 K	•	OD	IP20	UMBEPL100G01	1.300
Ceiling lamp white lower bowl white or black DIM TRIAC	1 led module 23 W - 4425 Lm - 3000 K	•	OD	IP20	UMBEPL100G04	1.375
Ceiling lamp white lower bowl white or black DIM DALI-Push DIM	1 led module 23 W - 4425 Lm - 3000 K	•	OD	IP20	UMBEPL100G11	1.405
Ceiling lamp white lower bowl in galvanized finishes NO DIM	1 led module 23 W - 4425 Lm - 3000 K	•	OD	IP20	UMBEPL100G03	1.430
Ceiling lamp white lower bowl in galvanized finishes DIM TRIAC	1 led module 23 W - 4425 Lm - 3000 K	•	OD	IP20	UMBEPL100G05	1.505
Ceiling lamp white lower bowl in galvanized finishes DIM DALI-Push DIM	1 led module 23 W - 4425 Lm - 3000 K	•	OD	IP20	UMBEPL100G13	1.540
LED temperature conversion filter from 3000K to 2700K	1 led module 23 W - 4425 Lm - 3000 K	•	OD	IP20	FLTCON0SP011	105
Surcharge gold leaf finish					UMBORO100G01	385

PRODUCTS: Orb

DESIGN: design: Büro Famos 2015

Single or in composition pendant lamp.

Painted matt white or black metal structure and in galvanic finishes brass or copper.

Globe diffuser in smoked PMMA or transparent glass.

Symbol Index  → • / present - / adsent OD / On Demand

ORB

DESCRIZIONE

SORGENTE



IP

CODICE

DESCRIZIONE	SORGENTE	Symbol	IP	CODICE	Price
Pendant lamp globe smoked PMMA - ø 25 Pendant lamp white NO DIM	1 led module 8,5 W - 1335 Lm - 3000 K - >80	-	OD IP20	ORBESO025M01	650
Pendant lamp black NO DIM	1 led module 8,5 W - 1335 Lm - 3000 K - >80	-	OD IP20	ORBESO025M02	650
Pendant lamp copper NO DIM	1 led module 8,5 W - 1335 Lm - 3000 K - >80	-	OD IP20	ORBESO025M04	725
Pendant lamp brass NO DIM	1 led module 8,5 W - 1335 Lm - 3000 K - >80	-	OD IP20	ORBESO025M05	725
Pendant lamp white DIM TRIAC	1 led module 8,5 W - 1335 Lm - 3000 K - >80	-	OD IP20	ORBESO025M06	725
Pendant lamp black DIM TRIAC	1 led module 8,5 W - 1335 Lm - 3000 K - >80	-	OD IP20	ORBESO025M07	725
Pendant lamp copper DIM TRIAC	1 led module 8,5 W - 1335 Lm - 3000 K - >80	-	OD IP20	ORBESO025M09	800
Pendant lamp brass DIM TRIAC	1 led module 8,5 W - 1335 Lm - 3000 K - >80	-	OD IP20	ORBESO025M10	800
Pendant lamp white DIM DALI-Push DIM	1 led module 8,5 W - 1335 Lm - 3000 K - >80	-	OD IP20	ORBESO025M11	805
Pendant lamp black DIM DALI-Push DIM	1 led module 8,5 W - 1335 Lm - 3000 K - >80	-	OD IP20	ORBESO025M12	805
Pendant lamp copper DIM DALI-Push DIM	1 led module 8,5 W - 1335 Lm - 3000 K - >80	-	OD IP20	ORBESO025M14	875
Pendant lamp brass DIM DALI-Push DIM	1 led module 8,5 W - 1335 Lm - 3000 K - >80	-	OD IP20	ORBESO025M15	875



200 cm
78.74"

41 cm
16.14"

25 cm
9.84"

PRODUCTS: Orb

DESIGN: design: Büro Famos 2015

Single or in composition pendant lamp.

Painted matt white or black metal structure and in galvanic finishes brass or copper.



Globe diffuser in smoked PMMA or transparent glass.

Symbol Index  → • / present - / adsent OD / On Demand

ORB

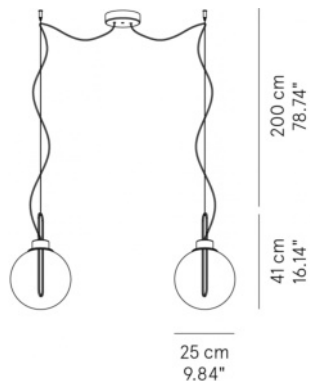
Composition 2 globes smoked PMMA - ø 25 - ceiling rose in the same color as structure



DESCRIZIONE	SORGENTE			IP	CODICE	
Composition white NO DIM	2 led module 8,5 W - 2x1335 Lm - 3000 K - >80	-	OD	IP20	ORBEC002M01	1.255
Composition black NO DIM	2 led module 8,5 W - 2x1335 Lm - 3000 K - >80	-	OD	IP20	ORBEC002M02	1.255
Composition copper NO DIM	2 led module 8,5 W - 2x1335 Lm - 3000 K - >80	-	OD	IP20	ORBEC002M04	1.395
Composition brass NO DIM	2 led module 8,5 W - 2x1335 Lm - 3000 K - >80	-	OD	IP20	ORBEC002M05	1.395
Composition white DIM TRIAC	2 led module 8,5 W - 2x1335 Lm - 3000 K - >80	-	OD	IP20	ORBEC002M06	1.280
Composition black DIM TRIAC	2 led module 8,5 W - 2x1335 Lm - 3000 K - >80	-	OD	IP20	ORBEC002M07	1.280
Composition copper DIM TRIAC	2 led module 8,5 W - 2x1335 Lm - 3000 K - >80	-	OD	IP20	ORBEC002M09	1.425
Composition brass DIM TRIAC	2 led module 8,5 W - 2x1335 Lm - 3000 K - >80	-	OD	IP20	ORBEC002M10	1.425
Composition white DIM DALI-Push DIM	2 led module 8,5 W - 2x1335 Lm - 3000 K - >80	-	OD	IP20	ORBEC002M11	1.345
Composition black DIM DALI-Push DIM	2 led module 8,5 W - 2x1335 Lm - 3000 K - >80	-	OD	IP20	ORBEC002M12	1.345
Composition copper DIM DALI-Push DIM	2 led module 8,5 W - 2x1335 Lm - 3000 K - >80	-	OD	IP20	ORBEC002M14	1.490
Composition brass DIM DALI-Push DIM	2 led module 8,5 W - 2x1335 Lm - 3000 K - >80	-	OD	IP20	ORBEC002M15	1.490

PRODUCTS: Orb

DESIGN: design: Büro Famos 2015

Single or in composition pendant lamp.

Painted matt white or black metal structure and in galvanic finishes brass or copper.

Globe diffuser in smoked PMMA or transparent glass.

Symbol Index  → • / present - / adsent OD / On Demand

ORB	DESCRIZIONE	SORGENTE			IP	CODICE	
	Pendant lamp globe smoked PMMA - ø 40 Pendant lamp white NO DIM	1 led module 16,2 W - 2400 Lm - 3000 K - >80	-	OD	IP20	ORBESO040M01	960
	Pendant lamp black NO DIM	1 led module 16,2 W - 2400 Lm - 3000 K - >80	-	OD	IP20	ORBESO040M02	960
	Pendant lamp copper NO DIM	1 led module 16,2 W - 2400 Lm - 3000 K - >80	-	OD	IP20	ORBESO040M04	1.180
	Pendant lamp brass NO DIM	1 led module 16,2 W - 2400 Lm - 3000 K - >80	-	OD	IP20	ORBESO040M05	1.180
	Pendant lamp white DIM TRIAC	1 led module 16,2 W - 2400 Lm - 3000 K - >80	-	OD	IP20	ORBESO040M06	1.030
	Pendant lamp black DIM TRIAC	1 led module 16,2 W - 2400 Lm - 3000 K - >80	-	OD	IP20	ORBESO040M07	1.030
	Pendant lamp copper DIM TRIAC	1 led module 16,2 W - 2400 Lm - 3000 K - >80	-	OD	IP20	ORBESO040M09	1.245
	Pendant lamp brass DIM TRIAC	1 led module 16,2 W - 2400 Lm - 3000 K - >80	-	OD	IP20	ORBESO040M10	1.245
	Pendant lamp white DIM DALI-Push DIM	1 led module 16,2 W - 2400 Lm - 3000 K - >80	-	OD	IP20	ORBESO040M11	1.090
	Pendant lamp black DIM DALI-Push DIM	1 led module 16,2 W - 2400 Lm - 3000 K - >80	-	OD	IP20	ORBESO040M12	1.090
	Pendant lamp copper DIM DALI-Push DIM	1 led module 16,2 W - 2400 Lm - 3000 K - >80	-	OD	IP20	ORBESO040M14	1.315
	Pendant lamp brass DIM DALI-Push DIM	1 led module 16,2 W - 2400 Lm - 3000 K - >80	-	OD	IP20	ORBESO040M15	1.315

PRODUCTS: Orb

DESIGN: design: Büro Famos 2015

Single or in composition pendant lamp.

Painted matt white or black metal structure and in galvanic finishes brass or copper.



Globe diffuser in smoked PMMA or transparent glass.

Symbol Index  → • / present - / adsent OD / On Demand

ORB

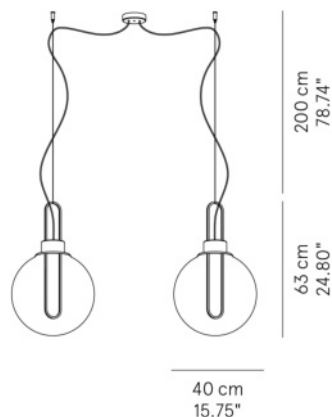
Composition 2 globes smoked PMMA - ø 40 - ceiling
rose in the same color as structure



DESCRIZIONE	SORGENTE			IP	CODICE	
Composition white NO DIM	2 led module 16,2 W - 2x2400 Lm - 3000 K - >80	-	OD	IP20	ORBECs040M01	1.690
Composition black NO DIM	2 led module 16,2 W - 2x2400 Lm - 3000 K - >80	-	OD	IP20	ORBECs040M02	1.690
Composition copper NO DIM	2 led module 16,2 W - 2x2400 Lm - 3000 K - >80	-	OD	IP20	ORBECs040M04	2.075
Composition brass NO DIM	2 led module 16,2 W - 2x2400 Lm - 3000 K - >80	-	OD	IP20	ORBECs040M05	2.075
Composition white DIM TRIAC	2 led module 16,2 W - 2x2400 Lm - 3000 K - >80	-	OD	IP20	ORBECs040M06	1.760
Composition black DIM TRIAC	2 led module 16,2 W - 2x2400 Lm - 3000 K - >80	-	OD	IP20	ORBECs040M07	1.760
Composition copper DIM TRIAC	2 led module 16,2 W - 2x2400 Lm - 3000 K - >80	-	OD	IP20	ORBECs040M09	2.140
Composition brass DIM TRIAC	2 led module 16,2 W - 2x2400 Lm - 3000 K - >80	-	OD	IP20	ORBECs040M10	2.140
Composition white DIM DALI-Push DIM	2 led module 16,2 W - 2x2400 Lm - 3000 K - >80	-	OD	IP20	ORBECs040M11	1.800
Composition black DIM DALI-Push DIM	2 led module 16,2 W - 2x2400 Lm - 3000 K - >80	-	OD	IP20	ORBECs040M12	1.800
Composition copper DIM DALI-Push DIM	2 led module 16,2 W - 2x2400 Lm - 3000 K - >80	-	OD	IP20	ORBECs040M14	2.185
Composition brass DIM DALI-Push DIM	2 led module 16,2 W - 2x2400 Lm - 3000 K - >80	-	OD	IP20	ORBECs040M15	2.185

PRODUCTS: Orb

DESIGN: design: Büro Famos 2015

Single or in composition pendant lamp.

Painted matt white or black metal structure and in galvanic finishes brass or copper.

Globe diffuser in smoked PMMA or transparent glass.



Symbol Index  → • / present - / adsent OD / On Demand

ORB

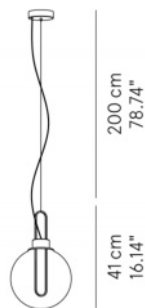
Pendant lamp globe glass - ø 25



25 cm
9.84"

DESCRIZIONE	SORGENTE			IP	CODICE	
Pendant lamp white NO DIM	1 led module 8,5 W - 1335 Lm - 3000 K - >80	•	OD	IP20	ORBESO025K01	850
Pendant lamp black NO DIM	1 led module 8,5 W - 1335 Lm - 3000 K - >80	•	OD	IP20	ORBESO025K02	850
Pendant lamp copper NO DIM	1 led module 8,5 W - 1335 Lm - 3000 K - >80	•	OD	IP20	ORBESO025K04	925
Pendant lamp brass NO DIM	1 led module 8,5 W - 1335 Lm - 3000 K - >80	•	OD	IP20	ORBESO025K05	925
Pendant lamp white DIM TRIAC	1 led module 8,5 W - 1335 Lm - 3000 K - >80	•	OD	IP20	ORBESO025K06	925
Pendant lamp black DIM TRIAC	1 led module 8,5 W - 1335 Lm - 3000 K - >80	•	OD	IP20	ORBESO025K07	925
Pendant lamp copper DIM TRIAC	1 led module 8,5 W - 1335 Lm - 3000 K - >80	•	OD	IP20	ORBESO025K09	1.000
Pendant lamp brass DIM TRIAC	1 led module 8,5 W - 1335 Lm - 3000 K - >80	•	OD	IP20	ORBESO025K10	1.000
Pendant lamp white DIM DALI-Push DIM	1 led module 8,5 W - 1335 Lm - 3000 K - >80	•	OD	IP20	ORBESO025K11	1.005
Pendant lamp black DIM DALI-Push DIM	1 led module 8,5 W - 1335 Lm - 3000 K - >80	•	OD	IP20	ORBESO025K12	1.005
Pendant lamp copper DIM DALI-Push DIM	1 led module 8,5 W - 1335 Lm - 3000 K - >80	•	OD	IP20	ORBESO025K14	1.075
Pendant lamp brass DIM DALI-Push DIM	1 led module 8,5 W - 1335 Lm - 3000 K - >80	•	OD	IP20	ORBESO025K15	1.075

PRODUCTS: Orb

DESIGN: design: Büro Famos 2015

Single or in composition pendant lamp.

Painted matt white or black metal structure and in galvanic finishes brass or copper.

Globe diffuser in smoked PMMA or transparent glass.

Symbol Index  → • / present - / adsent OD / On Demand

ORB

DESCRIZIONE

SORGENTE



IP

CODICE

Composition 2 globes glass - ø 25 - ceiling rose in the same color as structure

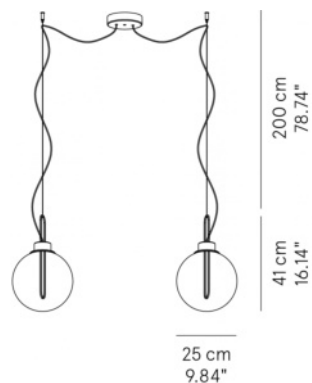

Composition white NO DIM	2 led module 8,5 W - 2x1335 Lm - 3000 K - >80	•	OD	IP20	ORBEC002K01	1.620
Composition black NO DIM	2 led module 8,5 W - 2x1335 Lm - 3000 K - >80	•	OD	IP20	ORBEC002K02	1.620
Composition copper NO DIM	2 led module 8,5 W - 2x1335 Lm - 3000 K - >80	•	OD	IP20	ORBEC002K04	1.790
Composition brass NO DIM	2 led module 8,5 W - 2x1335 Lm - 3000 K - >80	•	OD	IP20	ORBEC002K05	1.790
Composition white DIM TRIAC	2 led module 8,5 W - 2x1335 Lm - 3000 K - >80	•	OD	IP20	ORBEC002K06	1.650
Composition black DIM TRIAC	2 led module 8,5 W - 2x1335 Lm - 3000 K - >80	•	OD	IP20	ORBEC002K07	1.650
Composition copper DIM TRIAC	2 led module 8,5 W - 2x1335 Lm - 3000 K - >80	•	OD	IP20	ORBEC002K09	1.815
Composition brass DIM TRIAC	2 led module 8,5 W - 2x1335 Lm - 3000 K - >80	•	OD	IP20	ORBEC002K10	1.815
Composition white DIM DALI-Push DIM	2 led module 8,5 W - 2x1335 Lm - 3000 K - >80	•	OD	IP20	ORBEC002K11	1.710
Composition black DIM DALI-Push DIM	2 led module 8,5 W - 2x1335 Lm - 3000 K - >80	•	OD	IP20	ORBEC002K12	1.710
Composition copper DIM DALI-Push DIM	2 led module 8,5 W - 2x1335 Lm - 3000 K - >80	•	OD	IP20	ORBEC002K14	1.880
Composition brass DIM DALI-Push DIM	2 led module 8,5 W - 2x1335 Lm - 3000 K - >80	•	OD	IP20	ORBEC002K15	1.880

PRODUCTS: Orb

DESIGN: design: Büro Famos 2015

Single or in composition pendant lamp.

Painted matt white or black metal structure and in galvanic finishes brass or copper.

Globe diffuser in smoked PMMA or transparent glass.



Symbol Index  → • / present - / adsent OD / On Demand

ORB

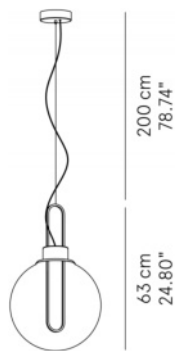
Pendant lamp globe glass - ø 40



40 cm
15.75"

DESCRIZIONE	SORGENTE			IP	CODICE	
Pendant lamp white NO DIM	1 led module 16,2 W - 2400 Lm - 3000 K - >80	•	OD	IP20	ORBESO040K01	1.420
Pendant lamp black NO DIM	1 led module 16,2 W - 2400 Lm - 3000 K - >80	•	OD	IP20	ORBESO040K02	1.420
Pendant lamp copper NO DIM	1 led module 16,2 W - 2400 Lm - 3000 K - >80	•	OD	IP20	ORBESO040K04	1.650
Pendant lamp brass NO DIM	1 led module 16,2 W - 2400 Lm - 3000 K - >80	•	OD	IP20	ORBESO040K05	1.650
Pendant lamp white DIM TRIAC	1 led module 16,2 W - 2400 Lm - 3000 K - >80	•	OD	IP20	ORBESO040K06	1.490
Pendant lamp black DIM TRIAC	1 led module 16,2 W - 2400 Lm - 3000 K - >80	•	OD	IP20	ORBESO040K07	1.490
Pendant lamp copper DIM TRIAC	1 led module 16,2 W - 2400 Lm - 3000 K - >80	•	OD	IP20	ORBESO040K09	1.720
Pendant lamp brass DIM TRIAC	1 led module 16,2 W - 2400 Lm - 3000 K - >80	•	OD	IP20	ORBESO040K10	1.720
Pendant lamp white DIM DALI-Push DIM	1 led module 16,2 W - 2400 Lm - 3000 K - >80	•	OD	IP20	ORBESO040K11	1.555
Pendant lamp black DIM DALI-Push DIM	1 led module 16,2 W - 2400 Lm - 3000 K - >80	•	OD	IP20	ORBESO040K12	1.555
Pendant lamp copper DIM DALI-Push DIM	1 led module 16,2 W - 2400 Lm - 3000 K - >80	•	OD	IP20	ORBESO040K14	1.785
Pendant lamp brass DIM DALI-Push DIM	1 led module 16,2 W - 2400 Lm - 3000 K - >80	•	OD	IP20	ORBESO040K15	1.785

PRODUCTS: Orb**DESIGN:** design: Büro Famos 2015

Single or in composition pendant lamp.

Painted matt white or black metal structure and in galvanic finishes brass or copper.

Globe diffuser in smoked PMMA or transparent glass.

Symbol Index  → • / present - / adsent OD / On Demand**ORB****DESCRIZIONE****SORGENTE****IP****CODICE**

Composition 2 globes glass - ø 40 - ceiling rose in the same color as structure

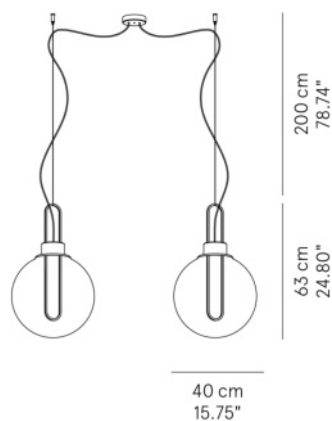

Composition white NO DIM	2 led module 16,2 W - 2x2400 Lm - 3000 K - >80	•	OD	IP20	ORBES040K01	2.615
Composition black NO DIM	2 led module 16,2 W - 2x2400 Lm - 3000 K - >80	•	OD	IP20	ORBES040K02	2.615
Composition copper NO DIM	2 led module 16,2 W - 2x2400 Lm - 3000 K - >80	•	OD	IP20	ORBES040K04	3.000
Composition brass NO DIM	2 led module 16,2 W - 2x2400 Lm - 3000 K - >80	•	OD	IP20	ORBES040K05	3.000
Composition white DIM TRIAC	2 led module 16,2 W - 2x2400 Lm - 3000 K - >80	•	OD	IP20	ORBES040K06	2.690
Composition black DIM TRIAC	2 led module 16,2 W - 2x2400 Lm - 3000 K - >80	•	OD	IP20	ORBES040K07	2.690
Composition copper DIM TRIAC	2 led module 16,2 W - 2x2400 Lm - 3000 K - >80	•	OD	IP20	ORBES040K09	3.070
Composition brass DIM TRIAC	2 led module 16,2 W - 2x2400 Lm - 3000 K - >80	•	OD	IP20	ORBES040K10	3.070
Composition white DIM DALI-Push DIM	2 led module 16,2 W - 2x2400 Lm - 3000 K - >80	•	OD	IP20	ORBES040K11	2.750
Composition black DIM DALI-Push DIM	2 led module 16,2 W - 2x2400 Lm - 3000 K - >80	•	OD	IP20	ORBES040K12	2.750
Composition copper DIM DALI-Push DIM	2 led module 16,2 W - 2x2400 Lm - 3000 K - >80	•	OD	IP20	ORBES040K14	3.135
Composition brass DIM DALI-Push DIM	2 led module 16,2 W - 2x2400 Lm - 3000 K - >80	•	OD	IP20	ORBES040K15	3.135

PRODUCTS: Peggy

DESIGN: design: Bellucci Mazzoni Progetti 2020

Pendant and ceiling lamp with double light emission in matt white or black painted metal.

Upper disc available in wool fabric with acoustic comfort features.

Conical metal diffuser painted white or black and in Deluxe finishing matt gold. Globe diffuser in opal PMMA soft touch finish (details matt black painted on demand).



On demand, globe available in polycarbonate, in accordance with the CL1 (650°) fire normative, with surcharge.

Symbol Index  → • / present - / absent OD / On Demand

PEGGY

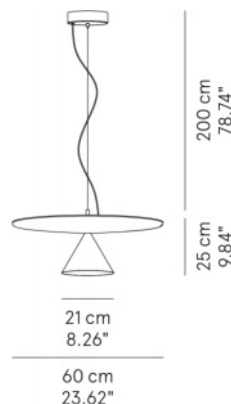
Pendant lamp - D. 60



DESCRIZIONE	SORGENTE			IP	CODICE	
Metal disk white or black		•	OD	IP20	PEGEDD060G01	265
Wool disk fabric		•	OD	IP20	PEGEDD060E01	455
Kit cone white or black	1xE27 + 3xR7Smax watt 1 X 42W HES + 3 X 75W	•	OD	IP20	PEGESO060G01	755
Kit cone Deluxe	1xE27 + 3xR7Smax watt 1 X 42W HES + 3 X 75W	•	OD	IP20	PEGESO060G11	830
Kit cone white or black NO DIM	2 led module 17W + 18W - 4500 Lm - 2700K	•	OD	IP20	PEGESO060G02	1.145
Kit cone Deluxe NO DIM	2 led module 17W + 18W - 4500 Lm - 2700K	•	OD	IP20	PEGESO060G12	1.225
Kit cone white or black DIM DALI Push-DIM	2 led module 17W + 18W - 4500 Lm - 2700K	•	OD	IP20	PEGESO060G03	1.285
Kit cone Deluxe DIM DALI Push-DIM	2 led module 17W + 18W - 4500 Lm - 2700K	•	OD	IP20	PEGESO060G13	1.365

Ball pendant lamp - D. 60

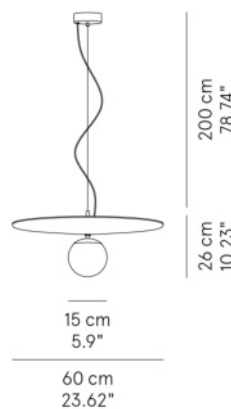

Metal disk white or black		•	OD	IP20	PEGEDD060G01	265
Wool disk fabric		•	OD	IP20	PEGEDD060E01	455
Kit globe in opal PMMA	1xE27 + 3xR7Smax watt 1 X 42W HES + 3 X 75W	OD	OD	IP20	PEBESO060M01	755

PRODUCTS: Peggy**DESIGN:** design: Bellucci Mazzoni Progetti 2020

Pendant and ceiling lamp with double light emission in matt white or black painted metal.

Upper disc available in wool fabric with acoustic comfort features.

Conical metal diffuser painted white or black and in Deluxe finishing matt gold. Globe diffuser in opal PMMA soft touch finish (details matt black painted on demand).

On demand, globe available in polycarbonate, in accordance with the CL1 (650°) fire normative, with surcharge.

Symbol Index   → • / present - / absent OD / On Demand**PEGGY****DESCRIZIONE****SORGENTE****IP****CODICE****Accessory**

Top polycarbonate disk cover for R7S version

OD IP20 PEGEPX040B01 80

40 cm
15.74"**Pendant lamp - D. 80**

Metal disk white or black

• OD IP20 PEGEDD080G01 395

Wool disk fabric

• OD IP20 PEGEDD080E01 710

Kit cone white or black

1xE27 + 3xR7Smax watt 1 X 42W HES + 3 X 105W

• OD IP20 PEGESO080G01 820

Kit cone Deluxe

1xE27 + 3xR7Smax watt 1 X 42W HES + 3 X 105W

• OD IP20 PEGESO080G11 920

Kit cone white or black NO DIM

2 led module 17W + 18W - 4500 Lm - 2700K

• OD IP20 PEGESO080G02 1.190

Kit cone Deluxe NO DIM

2 led module 17W + 18W - 4500 Lm - 2700K

• OD IP20 PEGESO080G12 1.285

Kit cone white or black DIM DALI Push-DIM

2 led module 17W + 18W - 4500 Lm - 2700K

• OD IP20 PEGESO080G03 1.335

Kit cone Deluxe DIM DALI Push-DIM

2 led module 17W + 18W - 4500 Lm - 2700K

• OD IP20 PEGESO080G13 1.430

26 cm
10.23"80 cm
31.49"

PRODUCTS: Peggy**DESIGN:** design: Bellucci Mazzoni Progetti 2020

Pendant and ceiling lamp with double light emission in matt white or black painted metal.

Upper disc available in wool fabric with acoustic comfort features.

Conical metal diffuser painted white or black and in Deluxe finishing matt gold. Globe diffuser in opal PMMA soft touch finish (details matt black painted on demand).

On demand, globe available in polycarbonate, in accordance with the CL1 (650°) fire normative, with surcharge.

Symbol Index  → • / present - / absent OD / On Demand**PEGGY****DESCRIZIONE****SORGENTE****IP****CODICE****Ball pendant lamp - D. 80**

Metal disk white or black

• OD IP20 PEGEDD080G01 395

Wool disk fabric

• OD IP20 PEGEDD080E01 710

Kit globe in opal PMMA

1xE27 + 3xR7Smax watt 1 X 42W HES + 3 X 105W

OD OD IP20 PEBESO080M01 830

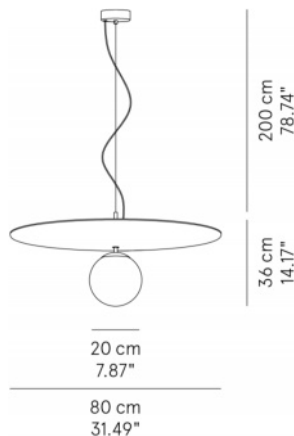
**Accessory**

Top polycarbonate disk cover for R7S version

OD IP20 PEGEPX040B01 80

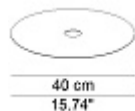

PRODUCTS: Peggy**DESIGN:** design: Bellucci Mazzoni Progetti 2020

Pendant and ceiling lamp with double light emission in matt white or black painted metal.

Upper disc available in wool fabric with acoustic comfort features.

Conical metal diffuser painted white or black and in Deluxe finishing matt gold. Globe diffuser in opal PMMA soft touch finish (details matt black painted on demand).

On demand, globe available in polycarbonate, in accordance with the CL1 (650°) fire normative, with surcharge.

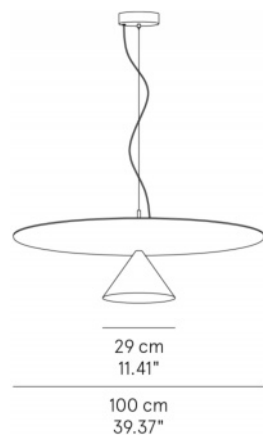
Symbol Index  → • / present - / absent OD / On Demand**PEGGY****DESCRIZIONE****SORGENTE****IP****CODICE****Pendant lamp - D. 100**

Metal disk white or black

• OD IP20 PEGEDD100G01 580

Wool disk fabric

• OD IP20 PEGEDD100E01 1.030

Kit cone white or black

1xE27 + 3xR7Smax watt 1 X 42W HES + 3 X 105W

• OD IP20 PEGESO100G01 860

Kit cone Deluxe

1xE27 + 3xR7Smax watt 1 X 42W HES + 3 X 105W

• OD IP20 PEGESO100G11 970

Kit cone white or black NO DIM

2 led module 17W + 18W - 4500 Lm - 2700K

• OD IP20 PEGESO100G02 1.245

Kit cone Deluxe NO DIM

2 led module 17W + 18W - 4500 Lm - 2700K

• OD IP20 PEGESO100G12 1.355

Kit cone white or black DIM DALI Push-DIM

2 led module 17W + 18W - 4500 Lm - 2700K

• OD IP20 PEGESO100G03 1.385

Kit cone Deluxe DIM DALI Push-DIM

2 led module 17W + 18W - 4500 Lm - 2700K

• OD IP20 PEGESO100G13 1.495



PRODUCTS: Peggy**DESIGN:** design: Bellucci Mazzoni Progetti 2020

Pendant and ceiling lamp with double light emission in matt white or black painted metal.

Upper disc available in wool fabric with acoustic comfort features.

Conical metal diffuser painted white or black and in Deluxe finishing matt gold. Globe diffuser in opal PMMA soft touch finish (details matt black painted on demand).

On demand, globe available in polycarbonate, in accordance with the CL1 (650°) fire normative, with surcharge.

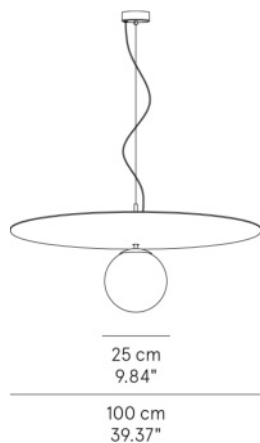
Symbol Index   → • / present - / absent OD / On Demand**PEGGY****DESCRIZIONE****SORGENTE****IP****CODICE****Ball pendant lamp - D. 100**

Metal disk white or black

•	OD	IP20	PEGEDD100G01	580
---	----	------	--------------	-----

Wool disk fabric

•	OD	IP20	PEGEDD100E01	1.030
---	----	------	--------------	-------

Kit globe in opal PMMA

1xE27 + 3xR7Smax watt 1 X 42W HES + 3 X 105W

OD	OD	IP20	PEBESO100M01	970
----	----	------	--------------	-----

Accessory

Top polycarbonate disk cover for R7S version

OD	IP20	PEGEPX040B01	80
----	------	--------------	----

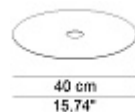

ATTENTION: to calculate the price of the pendant lamp add the disk to the kit cone or globe

-	0
---	---

PRODUCTS: Peggy**DESIGN:** design: Bellucci Mazzoni Progetti 2020



Pendant and ceiling lamp with double light emission in matt white or black painted metal.

Upper disc available in wool fabric with acoustic comfort features.

Conical metal diffuser painted white or black and in Deluxe finishing matt gold. Globe diffuser in opal PMMA soft touch finish (details matt black painted on demand).

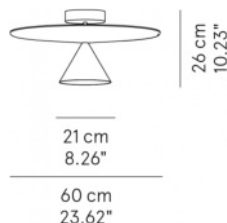
On demand, globe available in polycarbonate, in accordance with the CL1 (650°) fire normative, with surcharge.

Symbol Index  → • / present - / absent OD / On Demand**PEGGY****Ceiling lamp - D. 60**

DESCRIZIONE	SORGENTE			IP	CODICE	
Metal disk white or black		•	OD	IP20	PEGEDD060G01	265
Wool disk fabric		•	OD	IP20	PEGEDD060E01	455
Kit cone white or black	1xE27 + 3xR7Smax watt 1 X 42W HES + 3 X 75W	•	OD	IP20	PEGEPL060G01	710
Kit cone Deluxe	1xE27 + 3xR7Smax watt 1 X 42W HES + 3 X 75W	•	OD	IP20	PEGEPL060G11	790
Kit cone white or black NO DIM	2 led module 17W + 18W - 4500 Lm - 2700K	•	OD	IP20	PEGEPL060G02	1.145
Kit cone Deluxe NO DIM	2 led module 17W + 18W - 4500 Lm - 2700K	•	OD	IP20	PEGEPL060G12	1.225
Kit cone white or black DIM DALI Push-DIM	2 led module 17W + 18W - 4500 Lm - 2700K	•	OD	IP20	PEGEPL060G03	1.285
Kit cone Deluxe DIM DALI Push-DIM	2 led module 17W + 18W - 4500 Lm - 2700K	•	OD	IP20	PEGEPL060G13	1.365

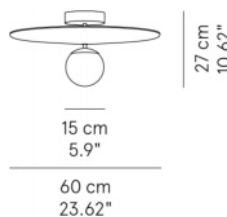
Ball ceiling lamp - D. 60

Metal disk white or black		•	OD	IP20	PEGEDD060G01	265
Wool disk fabric		•	OD	IP20	PEGEDD060E01	455
Kit globe in opal PMMA	1xE27 + 3xR7Smax watt 1 X 42W HES + 3 X 75W	OD	OD	IP20	PEBEPL060M01	710

PRODUCTS: Peggy

DESIGN: design: Bellucci Mazzoni Progetti 2020

Pendant and ceiling lamp with double light emission in matt white or black painted metal.

Upper disc available in wool fabric with acoustic comfort features.

Conical metal diffuser painted white or black and in Deluxe finishing matt gold. Globe diffuser in opal PMMA soft touch finish (details matt black painted on demand).



On demand, globe available in polycarbonate, in accordance with the CL1 (650°) fire normative, with surcharge.

Symbol Index  → • / present - / absent OD / On Demand

PEGGY

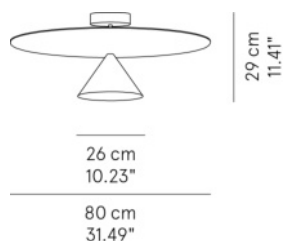
Ceiling lamp - D. 80



DESCRIZIONE	SORGENTE			IP	CODICE	
Metal disk white or black		•	OD	IP20	PEGEDD080G01	395
Wool disk fabric		•	OD	IP20	PEGEDD080E01	710
Kit cone white or black	1xE27 + 3xR7Smax watt 1 X 42W HES + 3 X 105W	•	OD	IP20	PEGEPL080G01	820
Kit cone Deluxe	1xE27 + 3xR7Smax watt 1 X 42W HES + 3 X 105W	•	OD	IP20	PEGEPL080G11	920
Kit cone white or black NO DIM	2 led module 17W + 18W - 4500 Lm - 2700K	•	OD	IP20	PEGEPL080G02	1.225
Kit cone Deluxe NO DIM	2 led module 17W + 18W - 4500 Lm - 2700K	•	OD	IP20	PEGEPL080G12	1.325
Kit cone white or black DIM DALI Push-DIM	2 led module 17W + 18W - 4500 Lm - 2700K	•	OD	IP20	PEGEPL080G03	1.365
Kit cone Deluxe DIM DALI Push-DIM	2 led module 17W + 18W - 4500 Lm - 2700K	•	OD	IP20	PEGEPL080G13	1.465

Ball ceiling lamp - D. 80

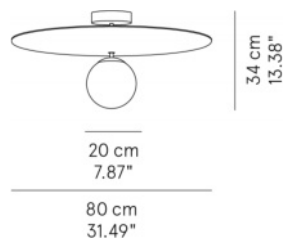

Metal disk white or black		•	OD	IP20	PEGEDD080G01	395
Wool disk fabric		•	OD	IP20	PEGEDD080E01	710
Kit globe in opal PMMA	1xE27 + 3xR7Smax watt 1 X 42W HES + 3 X 105W	OD	OD	IP20	PEBEPL080M01	840

PRODUCTS: Peggy

DESIGN: design: Bellucci Mazzoni Progetti 2020

Pendant and ceiling lamp with double light emission in matt white or black painted metal.

Upper disc available in wool fabric with acoustic comfort features.

Conical metal diffuser painted white or black and in Deluxe finishing matt gold. Globe diffuser in opal PMMA soft touch finish (details matt black painted on demand).

On demand, globe available in polycarbonate, in accordance with the CL1 (650°) fire normative, with surcharge.

Symbol Index  → • / present - / adsent OD / On Demand

PEGGY

Ceiling lamp - D. 100

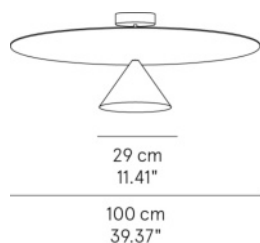

DESCRIZIONE

SORGENTE



IP

CODICE

Metal disk white or black

• OD IP20 PEGEDD100G01 580

Wool disk fabric

• OD IP20 PEGEDD100E01 1.030

Kit cone white or black

1xE27 + 3xR7Smax watt 1 X 42W HES + 3 X 105W

• OD IP20 PEGEPL100G01 910

Kit cone Deluxe

1xE27 + 3xR7Smax watt 1 X 42W HES + 3 X 105W

• OD IP20 PEGEPL100G11 1.015

Kit cone white or black NO DIM

2 led module 17W + 18W - 4500 Lm - 2700K

• OD IP20 PEGEPL100G02 1.315

Kit cone Deluxe NO DIM

2 led module 17W + 18W - 4500 Lm - 2700K

• OD IP20 PEGEPL100G12 1.420

Kit cone white or black DIM DALI Push-DIM

2 led module 17W + 18W - 4500 Lm - 2700K

• OD IP20 PEGEPL100G03 1.455

Kit cone Deluxe DIM DALI Push-DIM

2 led module 17W + 18W - 4500 Lm - 2700K

• OD IP20 PEGEPL100G13 1.560

Ball ceiling lamp - D. 100

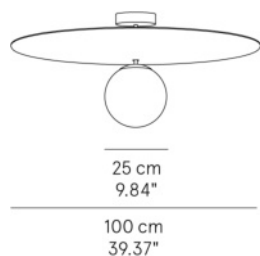

Metal disk white or black

• OD IP20 PEGEDD100G01 580

Wool disk fabric

• OD IP20 PEGEDD100E01 1.030

Kit globe in opal PMMA

1xE27 + 3xR7Smax watt 1 X 42W HES + 3 X 105W

OD OD IP20 PEBEPL100M01 950

ATTENTION: to calculate the price of the ceiling lamp add the disk to the kit cone or globe

- 0



PRODUCTS: Rettangolo

DESIGN: design: Modoluce R&D 2005

Pendant and wall lamp available in cotton or in hand finished pleated and pleated ribbon fabric.

On demand, lampshade available in Kvadrat fabric (with surcharge).

Opal plex finishing underneath (wall lamp excluded).

Symbol Index   → • / present - / absent OD / On Demand

RETTANGOLO

Pendant lamp - L 90

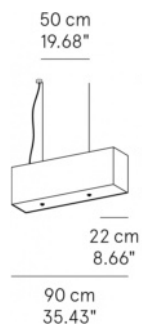

DESCRIZIONE

SORGENTE



IP

CODICE

Cotton	3xE27max watt 42 W HES	OD	OD	IP20	RETESP090C01	930
Pendant lamp pleated fabric	3xE27max watt 42 W HES	OD	OD	IP20	RETESP090P01	1.200
Pleated ribbon fabric	3xE27max watt 42 W HES	OD	OD	IP20	RETESP090R01	1.255

Pendant lamp - L 120

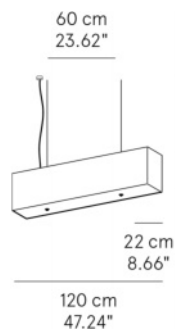

Cotton	4xE27max watt 42 W HES	OD	OD	IP20	RETESP120C01	1.090
Pendant lamp pleated fabric	4xE27max watt 42 W HES	OD	OD	IP20	RETESP120P01	1.585
Pleated ribbon fabric	4xE27max watt 42 W HES	OD	OD	IP20	RETESP120R01	1.660



PRODUCTS: Rettangolo

DESIGN: design: ModoLuce R&D 2005

Pendant and wall lamp available in cotton or in hand finished pleated and pleated ribbon fabric.

On demand, lampshade available in Kvadrat fabric (with surcharge).

Opal plex finishing underneath (wall lamp excluded).

Symbol Index   → • / present - / adsent OD / On Demand

RETTANGOLO

DESCRIZIONE

SORGENTE



IP

CODICE

Pendant lamp - L 150

Pendant lamp pleated fabric

6 E27 52 W -

OD

OD

IP20

RETESP150P02

2.785

Pleated ribbon fabric

6 E27 52 W -

OD

OD

IP20

RETESP150R02

2.895

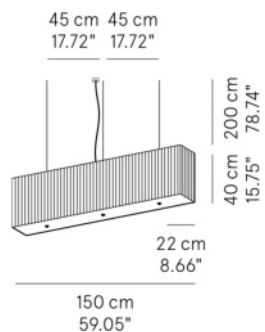

Pendant lamp - L 300

Pendant lamp pleated fabric

12 E27 52 W -

OD

OD

IP20

RETESP300P02

5.680

Pleated ribbon fabric

12 E27 52 W -

OD

OD

IP20

RETESP300R02

5.845

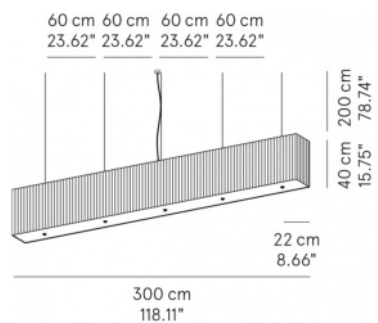

PRODUCTS: Rettangolo

DESIGN: design: ModoLuce R&D 2005

Pendant and wall lamp available in cotton or in hand finished pleated and pleated ribbon fabric.

On demand, lampshade available in Kvadrat fabric (with surcharge).



Opal plex finishing underneath (wall lamp excluded).

Symbol Index  → • / present - / absent OD / On Demand

RETTANGOLO

Wall lamp - L 25 x H 24



DESCRIZIONE	SORGENTE			IP	CODICE	
Cotton	1xE27max watt 28 W HES	OD	OD	IP20	QUAEAP024C01	250
Pleated fabric	1xE27max watt 28 W HES	•	OD	IP20	QUAEAP024P01	265
Pleated ribbon fabric	1xE27max watt 28 W HES	OD	OD	IP20	QUAEAP024R01	270

Wall lamp - L 25 x H 40



1 light cotton	1xE27max watt 42 W HES	OD	OD	IP20	RETEAP040C01	285
1 light pleated fabric	1xE27max watt 42 W HES	•	OD	IP20	RETEAP040P01	295
1 light pleated ribbon fabric	1xE27max watt 42 W HES	OD	OD	IP20	RETEAP040R01	305
2 lights cotton	2xE27max watt 42 W HES	OD	OD	IP20	RETEAP040C02	300
2 lights pleated fabric	2xE27max watt 42 W HES	•	OD	IP20	RETEAP040P02	310
2 lights pleated ribbon fabric	2xE27max watt 42 W HES	OD	OD	IP20	RETEAP040R02	320

Wall lamp - L 40 x H 25



1 light cotton	1xE27max watt 42 W HES	OD	OD	IP20	RETEAP025C01	300
1 light pleated fabric	1xE27max watt 42 W HES	•	OD	IP20	RETEAP025P01	310
1 light pleated ribbon fabric	1xE27max watt 42 W HES	OD	OD	IP20	RETEAP025R01	320
2 lights cotton	2xE27max watt 42 W HES	OD	OD	IP20	RETEAP025C02	315
2 lights pleated fabric	2xE27max watt 42 W HES	•	OD	IP20	RETEAP025P02	325
2 lights pleated ribbon fabric	2xE27max watt 42 W HES	OD	OD	IP20	RETEAP025R02	335

PRODUCTS: Rettangolo

DESIGN: design: ModoLuce R&D 2005

Pendant and wall lamp available in cotton or in hand finished pleated and pleated ribbon fabric.

On demand, lampshade available in Kvadrat fabric (with surcharge).

Opal plex finishing underneath (wall lamp excluded).

Symbol Index  → • / present - / adsent OD / On Demand

RETTANGOLO

Wall lamp - L 40 x H 40



40 cm 13 cm
15.75" 5.12"

DESCRIZIONE

SORGENTE



IP

CODICE

Cotton

2xE27max watt 42 W HES

OD OD IP20 QUAEAP040C01 360

Pleated fabric

2xE27max watt 42 W HES

• OD IP20 QUAEAP040P01 455

Pleated ribbon fabric

2xE27max watt 42 W HES

OD OD IP20 QUAEAP040R01 465

Wall lamp - L 30 x H 60



30 cm 13 cm
11.81" 5.12"

Cotton

2xE27max watt 42 W HES

OD OD IP20 RETEAP060C01 375

Pleated fabric

2xE27max watt 42 W HES

• OD IP20 RETEAP060P01 485

Pleated ribbon fabric

2xE27max watt 42 W HES

OD OD IP20 RETEAP060R01 500

PRODUCTS: Reverse Basic

DESIGN: design: Paolo Grasselli 2013

Pendant lamp in cotton, pleated and pleated ribbon fabric.

The cotton version is bicoloured inside/ outside (with color combinations from the sample folder).

Bottom cap in thermoformed opal PMMA with soft touch finishing.



Symbol Index  → • / present - / absent OD / On Demand

REVERSE

BASIC A - ø 60



A

DESCRIZIONE	SORGENTE			IP	CODICE	
Cotton NO DIM	1 led module 18 W - 3000 Lm - 2700 K	OD	OD	IP20	REAESO060C04	1.365
Cotton DIM TRIAC	1 led module 18 W - 3000 Lm - 2700 K	OD	OD	IP20	REAESO060C05	1.385
Cotton DIM DALI-Push DIM	1 led module 18 W - 3000 Lm - 2700 K	OD	OD	IP20	REAESO060C06	1.475
Pleated fabric NO DIM	1 led module 18 W - 3000 Lm - 2700 K	OD	OD	IP20	REAESO060P04	1.540
Pleated fabric DIM TRIAC	1 led module 18 W - 3000 Lm - 2700 K	OD	OD	IP20	REAESO060P05	1.560
Pleated fabric DIM DALI-Push DIM	1 led module 18 W - 3000 Lm - 2700 K	OD	OD	IP20	REAESO060P06	1.650
Pleated ribbon fabric NO DIM	1 led module 18 W - 3000 Lm - 2700 K	OD	OD	IP20	REAESO060R04	1.490
Pleated ribbon fabric DIM TRIAC	1 led module 18 W - 3000 Lm - 2700 K	OD	OD	IP20	REAESO060R05	1.510
Pleated ribbon fabric DIM DALI-Push DIM	1 led module 18 W - 3000 Lm - 2700 K	OD	OD	IP20	REAESO060R06	1.600

BASIC B - ø 60

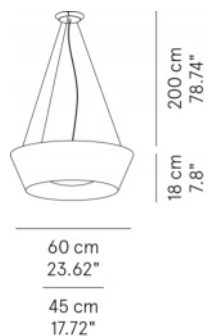



B

Cotton NO DIM	1 led module 18 W - 3000 Lm - 2700 K	OD	OD	IP20	REBESO060C04	1.400
Cotton DIM TRIAC	1 led module 18 W - 3000 Lm - 2700 K	OD	OD	IP20	REBESO060C05	1.425
Cotton DIM DALI-Push DIM	1 led module 18 W - 3000 Lm - 2700 K	OD	OD	IP20	REBESO060C06	1.510
Pleated fabric NO DIM	1 led module 18 W - 3000 Lm - 2700 K	OD	OD	IP20	REBESO060P04	1.585
Pleated fabric DIM TRIAC	1 led module 18 W - 3000 Lm - 2700 K	OD	OD	IP20	REBESO060P05	1.605
Pleated fabric DIM DALI-Push DIM	1 led module 18 W - 3000 Lm - 2700 K	OD	OD	IP20	REBESO060P06	1.690
Pleated ribbon fabric NO DIM	1 led module 18 W - 3000 Lm - 2700 K	OD	OD	IP20	REBESO060R04	1.530
Pleated ribbon fabric DIM TRIAC	1 led module 18 W - 3000 Lm - 2700 K	OD	OD	IP20	REBESO060R05	1.550
Pleated ribbon fabric DIM DALI-Push DIM	1 led module 18 W - 3000 Lm - 2700 K	OD	OD	IP20	REBESO060R06	1.640

PRODUCTS: Reverse Basic
DESIGN: design: Paolo Grasselli 2013

Pendant lamp in cotton, pleated and pleated ribbon fabric.
 The cotton version is bicoloured inside/ outside (with color combinations from the sample folder).
 Bottom cap in thermoformed opal PMMA with soft touch finishing.



Symbol Index   → • / present - / absent OD / On Demand

REVERSE

BASIC A - ø 80



A

DESCRIZIONE	SORGENTE			IP	CODICE	
Cotton NO DIM	1 led module 23 W - 3628 Lm - 2700 K	OD	OD	IP20	REAESO080C07	1.735
Cotton DIM TRIAC	1 led module 23 W - 3628 Lm - 2700 K	OD	OD	IP20	REAESO080C08	1.815
Cotton DIM DALI-Push DIM	1 led module 23 W - 3628 Lm - 2700 K	OD	OD	IP20	REAESO080C09	1.815
Pleated fabric NO DIM	1 led module 23 W - 3628 Lm - 2700 K	OD	OD	IP20	REAESO080P07	1.930
Pleated fabric DIM TRIAC	1 led module 23 W - 3628 Lm - 2700 K	OD	OD	IP20	REAESO080P08	2.020
Pleated fabric DIM DALI-Push DIM	1 led module 23 W - 3628 Lm - 2700 K	OD	OD	IP20	REAESO080P09	2.020
Pleated ribbon fabric NO DIM	1 led module 23 W - 3628 Lm - 2700 K	OD	OD	IP20	REAESO080R07	1.870
Pleated ribbon fabric DIM TRIAC	1 led module 23 W - 3628 Lm - 2700 K	OD	OD	IP20	REAESO080R08	1.955
Pleated ribbon fabric DIM DALI-Push DIM	1 led module 23 W - 3628 Lm - 2700 K	OD	OD	IP20	REAESO080R09	1.955

BASIC B - ø 80

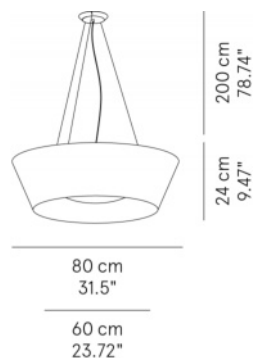

B

Cotton NO DIM	1 led module 23 W - 3628 Lm - 2700 K	OD	OD	IP20	REBESO080C07	1.750
Cotton DIM TRIAC	1 led module 23 W - 3628 Lm - 2700 K	OD	OD	IP20	REBESO080C08	1.830
Cotton DIM DALI-Push DIM	1 led module 23 W - 3628 Lm - 2700 K	OD	OD	IP20	REBESO080C09	1.830
Pleated fabric NO DIM	1 led module 23 W - 3628 Lm - 2700 K	OD	OD	IP20	REBESO080P07	1.935
Pleated fabric DIM TRIAC	1 led module 23 W - 3628 Lm - 2700 K	OD	OD	IP20	REBESO080P08	2.025
Pleated fabric DIM DALI-Push DIM	1 led module 23 W - 3628 Lm - 2700 K	OD	OD	IP20	REBESO080P09	2.025
Pleated ribbon fabric NO DIM	1 led module 23 W - 3628 Lm - 2700 K	OD	OD	IP20	REBESO080R07	1.885
Pleated ribbon fabric DIM TRIAC	1 led module 23 W - 3628 Lm - 2700 K	OD	OD	IP20	REBESO080R08	1.970
Pleated ribbon fabric DIM DALI-Push DIM	1 led module 23 W - 3628 Lm - 2700 K	OD	OD	IP20	REBESO080R09	1.970



PRODUCTS: Righello

DESIGN: design: Arturo Bellese 2018

Pendant lamp with double light emission, lampshade available in wool, cubic and bubble fabrics.

Double light emission: L 125 Up 2560 lm - Down 5120 lm / L 160 Up 2560 lm - Down 6400 lm



Lamp with acoustic comfort features.

Symbol Index   → • / present - / adsent OD / On Demand

RIGHELLO

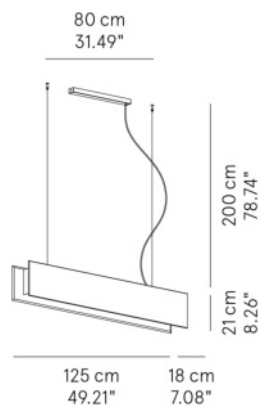
Pendant lamp - L 125



DESCRIZIONE	SORGENTE			IP	CODICE	
Wool NO DIM	2 linear modules 48 W - 8070 Lm - 3000 K	•	OD	IP20	RIGESO125E01	1.955
Wool DIM DALI-Push DIM	2 linear modules 48 W - 8070 Lm - 3000 K	•	OD	IP20	RIGESO125E02	2.020
Pendant lamp cubic NO DIM	2 linear modules 48 W - 8070 Lm - 3000 K	•	OD	IP20	RIGESO125A01	2.170
Pendant lamp cubic DIM DALI-Push DIM	2 linear modules 48 W - 8070 Lm - 3000 K	•	OD	IP20	RIGESO125A02	2.235
Pendant lamp bubble NO DIM	2 linear modules 48 W - 8070 Lm - 3000 K	•	OD	IP20	RIGESO125S01	1.830
Pendant lamp bubble DIM DALI-Push DIM	2 linear modules 48 W - 8070 Lm - 3000 K	•	OD	IP20	RIGESO125S02	1.900

Pendant lamp - L 160

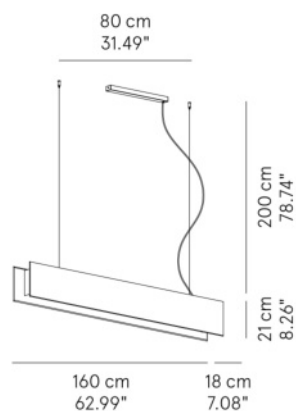

Wool NO DIM	2 linear modules 56 W - 9410 Lm - 3000 K	•	OD	IP20	RIGESO160E01	2.385
Wool DIM DALI-Push DIM	2 linear modules 56 W - 9410 Lm - 3000 K	•	OD	IP20	RIGESO160E02	2.450
Pendant lamp cubic NO DIM	2 linear modules 56 W - 9410 Lm - 3000 K	•	OD	IP20	RIGESO160A01	2.600
Pendant lamp cubic DIM DALI-Push DIM	2 linear modules 56 W - 9410 Lm - 3000 K	•	OD	IP20	RIGESO160A02	2.665
Pendant lamp bubble NO DIM	2 linear modules 56 W - 9410 Lm - 3000 K	•	OD	IP20	RIGESO160S01	2.265
Pendant lamp bubble DIM DALI-Push DIM	2 linear modules 56 W - 9410 Lm - 3000 K	•	OD	IP20	RIGESO160S02	2.330

PRODUCTS: Ring
DESIGN: design: Paolo Grasselli 2014



Pendant, wall/ ceiling lamp with diffuser in removable and washable lycra.
 Fire retardant lycra fabric, in accordance with the CL1 (650°) fire normative.

Symbol Index  → • / present - / absent OD / On Demand

RING

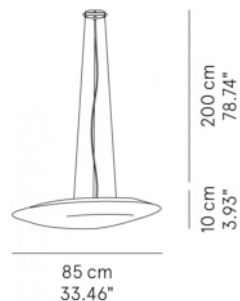
Pendant lamp - L 85



DESCRIZIONE	SORGENTE			IP	CODICE	
1 light lycra NO DIM	1 led module 23 W - 3628 Lm - 2700 K	OD	OD	IP20	RINESO085L04	1.245
1 light lycra DIM TRIAC	1 led module 23 W - 3628 Lm - 2700 K	OD	OD	IP20	RINESO085L05	1.315
1 light lycra DIM DALI-Push DIM	1 led module 23 W - 3628 Lm - 2700 K	OD	OD	IP20	RINESO085L06	1.345
Lycra cover only		•			RINERR085L01	345

Pendant lamp - L 125



1 light lycra NO DIM	1 led module 88 W - 12380 Lm - 2700 K	OD	OD	IP20	RINESO125L07	1.850
1 light lycra DIM DALI-Push DIM	1 led module 88 W - 12380 Lm - 2700 K	OD	OD	IP20	RINESO125L08	2.040
Lycra cover only		•			RINERR125L01	405



NOTE: on demand, LED modules are also available in 3000K and 4000K, without surcharge.

- 0

PRODUCTS: Ring
DESIGN: design: Paolo Grasselli 2014

Pendant, wall/ ceiling lamp with diffuser in removable and washable lycra.
 Fire retardant lycra fabric, in accordance with the CL1 (650°) fire normative.

Symbol Index  → • / present - / absent OD / On Demand

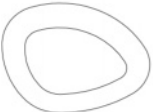
RING	DESCRIZIONE	SORGENTE	IP			CODICE	
					IP		
 12 cm 4.72"  67 cm 26.38" 85 cm 33.46"	1 light lycra NO DIM	1 led module 23 W - 3628 Lm - 2700 K	OD	OD	IP20	RINEAP085L04	1.125
	1 light lycra DIM TRIAC	1 led module 23 W - 3628 Lm - 2700 K	OD	OD	IP20	RINEAP085L05	1.145
	1 light lycra DIM DALI-Push DIM	1 led module 23 W - 3628 Lm - 2700 K	OD	OD	IP20	RINEAP085L06	1.225
	Lycra cover only		•			RINERR085L01	345

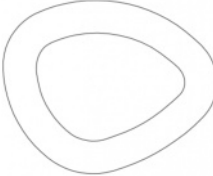
 12 cm 4.72"  100 cm 39.37" 125 cm 49.21"	1 light lycra NO DIM	1 led module 88 W - 12380 Lm - 2700 K	OD	OD	IP20	RINEAP125L07	1.740
	1 light lycra DIM DALI-Push DIM	1 led module 88 W - 12380 Lm - 2700 K	OD	OD	IP20	RINEAP125L08	1.915
	Lycra cover only		•			RINERR125L01	405

NOTE: on demand, LED modules are also available in 3000K and 4000K, without surcharge.

- 0

PRODUCTS: Ring Tonda

DESIGN: design: Paolo Grasselli 2016

Pendant, wall/ ceiling lamp with diffuser in removable and washable lycra.
Fire retardant lycra fabric, in accordance with the CL1 (650°) fire normative.

Symbol Index  → • / present - / absent OD / On Demand

RING TONDA

Pendant lamp - D. 65

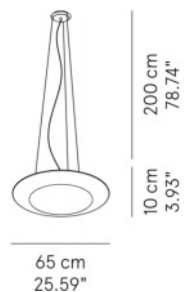

DESCRIZIONE

SORGENTE



IP

CODICE

1 light lycra NO DIM	1 led module 23 W - 3628 Lm - 2700 K	OD	OD	IP20	RITESO065L04	1.255
1 light lycra DIM TRIAC	1 led module 23 W - 3628 Lm - 2700 K	OD	OD	IP20	RITESO065L05	1.325
1 light lycra DIM DALI-Push DIM	1 led module 23 W - 3628 Lm - 2700 K	OD	OD	IP20	RITESO065L06	1.355
Lycra cover only		•			RITERR065L01	195

Pendant lamp - D. 85

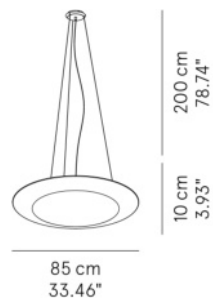

1 light lycra NO DIM	1 led module 57 W - 8750 Lm - 2700 K	OD	OD	IP20	RITESO085L09	1.630
1 light lycra DIM TRIAC	1 led module 57 W - 8750 Lm - 2700 K	OD	OD	IP20	RITESO085L11	1.700
1 light lycra DIM DALI-push DIM	1 led module 57 W - 8750 Lm - 2700 K	OD	OD	IP20	RITESO085L10	1.785
Lycra cover only		•			RITERR085L01	325

PRODUCTS: Ring Tonda
DESIGN: design: Paolo Grasselli 2016



Pendant, wall/ ceiling lamp with diffuser in removable and washable lycra.
 Fire retardant lycra fabric, in accordance with the CL1 (650°) fire normative.

Symbol Index  → • / present - / absent OD / On Demand

RING TONDA

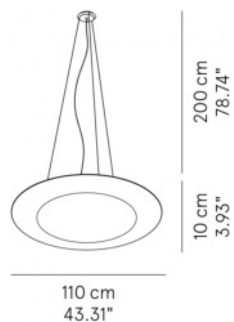
Pendant lamp - D. 110



DESCRIZIONE	SORGENTE			IP	CODICE	
1 light lycra NO DIM	1 led module 88 W - 12380 Lm - 2700 K	OD	OD	IP20	RITESO110L07	1.965
1 light lycra DIM DALI-Push DIM	1 led module 88 W - 12380 Lm - 2700 K	OD	OD	IP20	RITESO110L08	2.165
Lycra cover only		•			RITERR110L01	405

NOTE: on demand, LED modules are also available in 3000K and 4000K, without surcharge. - 0

Wall/Ceiling lamp - D. 65

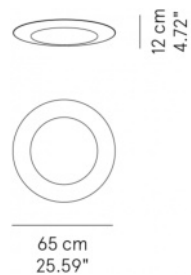

1 light lycra NO DIM	1 led module 23 W - 3628 Lm - 2700 K	OD	OD	IP20	RITEAP065L04	1.125
1 light lycra DIM TRIAC	1 led module 23 W - 3628 Lm - 2700 K	OD	OD	IP20	RITEAP065L05	1.200
1 light lycra DIM DALI-Push DIM	1 led module 23 W - 3628 Lm - 2700 K	OD	OD	IP20	RITEAP065L06	1.190
Lycra cover only		•			RITERR065L01	195

PRODUCTS: Ring Tonda
DESIGN: design: Paolo Grasselli 2016

Pendant, wall/ ceiling lamp with diffuser in removable and washable lycra.
 Fire retardant lycra fabric, in accordance with the CL1 (650°) fire normative.

Symbol Index  → • / present - / absent OD / On Demand

RING TONDA

Wall/Ceiling lamp - D. 85



12 cm
4.72"



85 cm
33.46"

DESCRIZIONE

SORGENTE



IP

CODICE

1 light lycra NO DIM

1 led module 57 W - 8750 Lm - 2700 K

OD OD IP20 RITEAP085L09 1.495

1 light lycra DIM TRIAC

1 led module 57 W - 8750 Lm - 2700 K

OD OD IP20 RITEAP085L11 1.575

1 light lycra DIM DALI-push DIM

1 led module 57 W - 8750 Lm - 2700 K

OD OD IP20 RITEAP085L10 1.620

Lycra cover only

• RITERR085L01 325

Wall/Ceiling lamp - D. 110



12 cm
4.72"

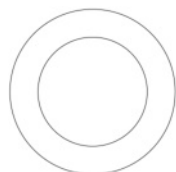

110 cm
43.31"

1 light lycra NO DIM

1 led module 88 W - 12380 Lm - 2700 K

OD OD IP20 RITEAP110L07 1.830

1 light lycra DIM DALI-push DIM

1 led module 88 W - 12380 Lm - 2700 K

OD OD IP20 RITEAP110L08 2.030

Lycra cover only

• RITERR110L01 405

NOTE: on demand, LED modules are also available in 3000K and 4000K, without surcharge.

- 0

PRODUCTS: Romeo

DESIGN: design: ModoLuce R&D 2003

Reading and floor lamp.

Metal structure in brushed nickel finishing, available in matt white and black on demand.

Lampshade in cotton fabric, available in Kvadrat fabric upon demand (with surcharge).

Symbol Index  → • / present - / adsent OD / On Demand

ROMEO

DESCRIZIONE

SORGENTE



IP

CODICE

Reading lamp - lighting pull

Metal brushed nickel cotton

1xE27max watt 70 W HES

OD

OD

IP20

ROMEPT160C01

665

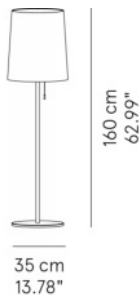

Floor lamp - lighting pull

Metal brushed nickel cotton

1xE27max watt 70 W HES

OD

OD

IP20

ROMEPT180C01

820



Metal brushed nickel cotton

3xE27max watt 42 W HES

OD

OD

IP20

ROMEPT180C11

960



PRODUCTS: Romeo

DESIGN: design: ModoLuce R&D 2003

Reading and floor lamp.

Metal structure in brushed nickel finishing, available in matt white and black on demand.

Lampshade in cotton fabric, available in Kvadrat fabric upon demand (with surcharge).

Symbol Index   → • / present - / adsent OD / On Demand

ROMEO

DESCRIZIONE

SORGENTE



IP

CODICE

Floor lamp

Metal brushed nickel cotton

4xE27max watt 70 W HES

OD OD IP20 ROMEPT212C01 1.530

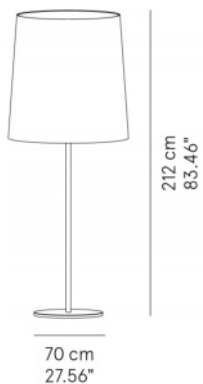

Accessory - Reading and floor lamp

Universal DIM switch HES + LED (5/250W)

DIMVAROPT003 130

